

## Chapter 8

# EXERGY – A MEASURE OF WORK POTENTIAL

### Exergy, Irreversibility, Reversible Work, and Second-Law Efficiency

**8-1C** Reversible work differs from the useful work by irreversibilities. For reversible processes both are identical.  $W_u = W_{\text{rev}} - I$ .

**8-2C** Reversible work and irreversibility are identical for processes that involve no actual useful work.

**8-3C** The dead state.

**8-4C** Yes; exergy is a function of the state of the surroundings as well as the state of the system.

**8-5C** Useful work differs from the actual work by the surroundings work. They are identical for systems that involve no surroundings work such as steady-flow systems.

**8-6C** Yes.

**8-7C** No, not necessarily. The well with the higher temperature will have a higher exergy.

**8-8C** The system that is at the temperature of the surroundings has zero exergy. But the system that is at a lower temperature than the surroundings has some exergy since we can run a heat engine between these two temperature levels.

**8-9C** They would be identical.

**8-10C** The second-law efficiency is a measure of the performance of a device relative to its performance under reversible conditions. It differs from the first law efficiency in that it is not a conversion efficiency.

**8-11C** No. The power plant that has a lower thermal efficiency may have a higher second-law efficiency.

**8-12C** No. The refrigerator that has a lower COP may have a higher second-law efficiency.

**8-13C** A processes with  $W_{\text{rev}} = 0$  is reversible if it involves no actual useful work. Otherwise it is irreversible.

**8-14C** Yes.

**8-15** Windmills are to be installed at a location with steady winds to generate power. The minimum number of windmills that need to be installed is to be determined.

**Assumptions** Air is at standard conditions of 1 atm and 25°C

**Properties** The gas constant of air is 0.287 kPa·m<sup>3</sup>/kg·K (Table A-1).

**Analysis** The exergy or work potential of the blowing air is the kinetic energy it possesses,

$$\text{Exergy} = ke = \frac{V^2}{2} = \frac{(8 \text{ m/s})^2}{2} \left( \frac{1 \text{ kJ/kg}}{1000 \text{ m}^2/\text{s}^2} \right) = 0.032 \text{ kJ/kg}$$

At standard atmospheric conditions (25°C, 101 kPa), the density and the mass flow rate of air are

$$\rho = \frac{P}{RT} = \frac{101 \text{ kPa}}{(0.287 \text{ kPa} \cdot \text{m}^3/\text{kg} \cdot \text{K})(298 \text{ K})} = 1.18 \text{ m}^3/\text{kg}$$

and

$$\dot{m} = \rho AV_1 = \rho \frac{\pi D^2}{4} V_1 = (1.18 \text{ kg/m}^3) \left( \frac{\pi}{4} \right) (10 \text{ m})^2 (8 \text{ m/s}) = 742 \text{ kg/s}$$

Thus,

$$\text{Available Power} = \dot{m}ke = (742 \text{ kg/s})(0.032 \text{ kJ/kg}) = 23.74 \text{ kW}$$

The minimum number of windmills that needs to be installed is

$$N = \frac{\dot{W}_{\text{total}}}{\dot{W}} = \frac{600 \text{ kW}}{23.74 \text{ kW}} = 25.3 \cong \mathbf{26 \text{ windmills}}$$

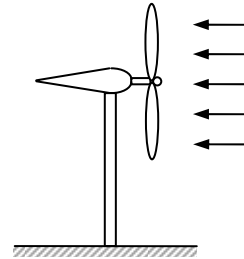

**8-16E** Saturated steam is generated in a boiler by transferring heat from the combustion gases. The wasted work potential associated with this heat transfer process is to be determined. Also, the effect of increasing the temperature of combustion gases on the irreversibility is to be discussed.

**Assumptions** 1 Steady operating conditions exist. 2 Kinetic and potential energy changes are negligible.

**Analysis** The properties of water at the inlet and outlet of the boiler and at the dead state are (Tables A-4E through A-6E)

$$\begin{aligned} P_1 = 200 \text{ psia} & \quad \left. \begin{array}{l} h_1 = h_f = 355.46 \text{ Btu/lbm} \\ s_1 = s_f = 0.54379 \text{ Btu/lbm} \cdot \text{R} \end{array} \right\} \\ x_1 = 0 \text{ (sat. liq.)} & \\ P_2 = 200 \text{ psia} & \quad \left. \begin{array}{l} h_2 = h_g = 1198.8 \text{ Btu/lbm} \\ s_2 = s_g = 1.5460 \text{ Btu/lbm} \cdot \text{R} \end{array} \right\} \\ x_2 = 1 \text{ (sat. vap.)} & \\ T_0 = 80^\circ\text{F} & \quad \left. \begin{array}{l} h_0 \cong h_{f@80^\circ\text{F}} = 48.07 \text{ Btu/lbm} \\ s_0 \cong s_{f@80^\circ\text{F}} = 0.09328 \text{ Btu/lbm} \cdot \text{R} \end{array} \right\} \\ P_0 = 14.7 \text{ psia} & \end{aligned}$$

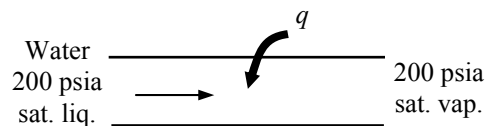

The heat transfer during the process is

$$q_{\text{in}} = h_2 - h_1 = 1198.8 - 355.46 = 843.3 \text{ Btu/lbm}$$

The entropy generation associated with this process is

$$\begin{aligned} s_{\text{gen}} &= \Delta s_w + \Delta s_R = (s_2 - s_1) - \frac{q_{\text{in}}}{T_R} \\ &= (1.5460 - 0.54379) \text{ Btu/lbm} \cdot \text{R} - \frac{843.3 \text{ Btu/lbm}}{(500 + 460) \text{ R}} \\ &= 0.12377 \text{ Btu/lbm} \cdot \text{R} \end{aligned}$$

The wasted work potential (exergy destruction) is

$$x_{\text{dest}} = T_0 s_{\text{gen}} = (80 + 460 \text{ R})(0.12377 \text{ Btu/lbm} \cdot \text{R}) = \mathbf{66.8 \text{ Btu/lbm}}$$

The work potential (exergy) of the steam stream is

$$\begin{aligned} \Delta \psi_w &= h_2 - h_1 - T_0(s_2 - s_1) \\ &= (1198.8 - 355.46) \text{ Btu/lbm} - (540 \text{ R})(1.5460 - 0.54379) \text{ Btu/lbm} \cdot \text{R} \\ &= 302.1 \text{ Btu/lbm} \end{aligned}$$

Increasing the temperature of combustion gases does not effect the work potential of steam stream since it is determined by the states at which water enters and leaves the boiler.

**Discussion** This problem may also be solved as follows:

Exergy transfer by heat transfer:

$$x_{\text{heat}} = q \left( 1 - \frac{T_0}{T_R} \right) = (843.3) \left( 1 - \frac{540}{960} \right) = 368.9 \text{ Btu/lbm}$$

Exergy increase of steam:

$$\Delta \psi_w = 302.1 \text{ Btu/lbm}$$

The net exergy destruction:

$$x_{\text{dest}} = x_{\text{heat}} - \Delta \psi_w = 368.9 - 302.1 = \mathbf{66.8 \text{ Btu/lbm}}$$

**8-17** Water is to be pumped to a high elevation lake at times of low electric demand for use in a hydroelectric turbine at times of high demand. For a specified energy storage capacity, the minimum amount of water that needs to be stored in the lake is to be determined.

**Assumptions** The evaporation of water from the lake is negligible.

**Analysis** The exergy or work potential of the water is the potential energy it possesses,

$$\text{Exergy} = PE = mgh$$

Thus,

$$m = \frac{PE}{gh} = \frac{5 \times 10^6 \text{ kWh}}{(9.8 \text{ m/s}^2)(75 \text{ m})} \left( \frac{3600 \text{ s}}{1 \text{ h}} \right) \left( \frac{1000 \text{ m}^2/\text{s}^2}{1 \text{ kW} \cdot \text{s}/\text{kg}} \right) = \mathbf{2.45 \times 10^{10} \text{ kg}}$$

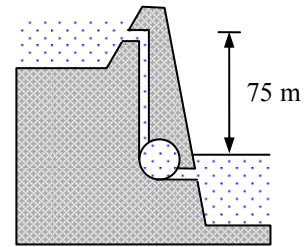

**8-18** A heat reservoir at a specified temperature can supply heat at a specified rate. The exergy of this heat supplied is to be determined.

**Analysis** The exergy of the supplied heat, in the rate form, is the amount of power that would be produced by a reversible heat engine,

$$\eta_{\text{th,max}} = \eta_{\text{th,rev}} = 1 - \frac{T_0}{T_H} = 1 - \frac{298 \text{ K}}{1500 \text{ K}} = 0.8013$$

$$\begin{aligned} \text{Exergy} &= \dot{W}_{\text{max,out}} = \dot{W}_{\text{rev,out}} = \eta_{\text{th,rev}} \dot{Q}_{\text{in}} \\ &= (0.8013)(150,000 / 3600 \text{ kJ/s}) \\ &= \mathbf{33.4 \text{ kW}} \end{aligned}$$

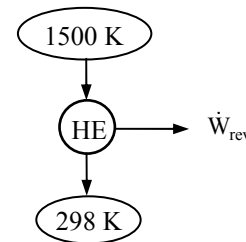

**8-19** [Also solved by EES on enclosed CD] A heat engine receives heat from a source at a specified temperature at a specified rate, and rejects the waste heat to a sink. For a given power output, the reversible power, the rate of irreversibility, and the 2<sup>nd</sup> law efficiency are to be determined.

**Analysis** (a) The reversible power is the power produced by a reversible heat engine operating between the specified temperature limits,

$$\eta_{\text{th,max}} = \eta_{\text{th,rev}} = 1 - \frac{T_L}{T_H} = 1 - \frac{320 \text{ K}}{1500 \text{ K}} = 0.787$$

$$\dot{W}_{\text{rev,out}} = \eta_{\text{th,rev}} \dot{Q}_{\text{in}} = (0.787)(700 \text{ kJ/s}) = \mathbf{550.7 \text{ kW}}$$

(b) The irreversibility rate is the difference between the reversible power and the actual power output:

$$\dot{i} = \dot{W}_{\text{rev,out}} - \dot{W}_{\text{u,out}} = 550.7 - 320 = \mathbf{230.7 \text{ kW}}$$

(c) The second law efficiency is determined from its definition,

$$\eta_{\text{II}} = \frac{W_{\text{u,out}}}{W_{\text{rev,out}}} = \frac{320 \text{ kW}}{550.7 \text{ kW}} = \mathbf{58.1\%}$$

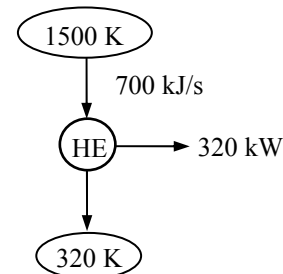

**8-20 EES** Problem 8-19 is reconsidered. The effect of reducing the temperature at which the waste heat is rejected on the reversible power, the rate of irreversibility, and the second law efficiency is to be studied and the results are to be plotted.

**Analysis** The problem is solved using EES, and the solution is given below.

"Input Data"

T\_H= 1500 [K]

Q\_dot\_H= 700 [kJ/s]

{T\_L=320 [K]}

W\_dot\_out = 320 [kW]

T\_Lsurr =25 [C]

"The reversible work is the maximum work done by the Carnot Engine between T\_H and T\_L:"

Eta\_Carnot=1 - T\_L/T\_H

W\_dot\_rev=Q\_dot\_H\*Eta\_Carnot

"The irreversibility is given as:"

I\_dot = W\_dot\_rev-W\_dot\_out

"The thermal efficiency is, in percent:"

Eta\_th = Eta\_Carnot\*Convert(, %)

"The second law efficiency is, in percent:"

Eta\_II = W\_dot\_out/W\_dot\_rev\*Convert(, %)

$\eta_{II}$ [%]	I [kJ/s]	$W_{rev}$ [kJ/s]	$T_L$ [K]
68.57	146.7	466.7	500
67.07	157.1	477.1	477.6
65.63	167.6	487.6	455.1
64.25	178.1	498.1	432.7
62.92	188.6	508.6	410.2
61.65	199	519	387.8
60.43	209.5	529.5	365.3
59.26	220	540	342.9
58.13	230.5	550.5	320.4
57.05	240.9	560.9	298

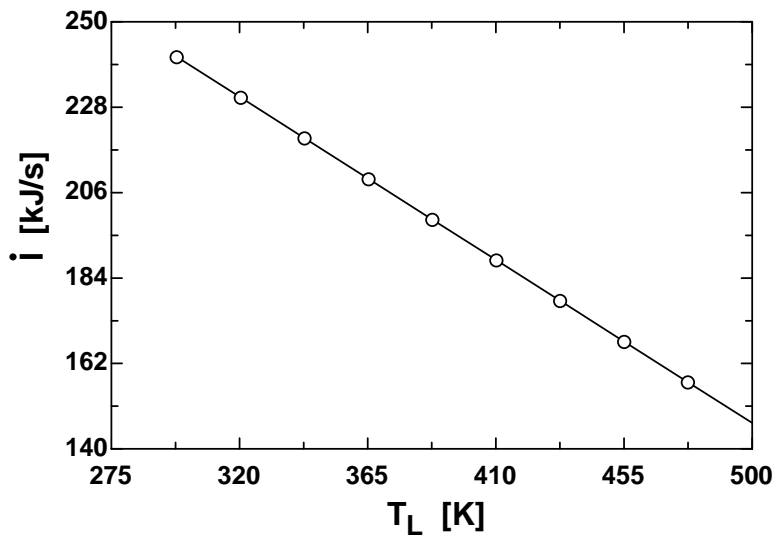
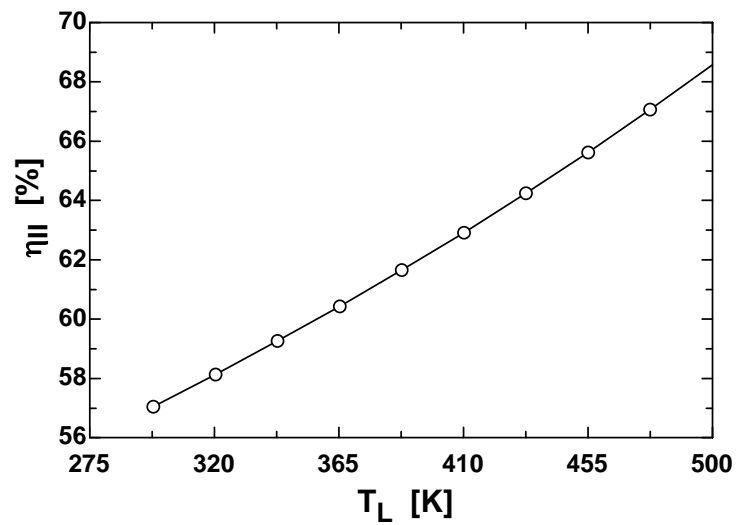
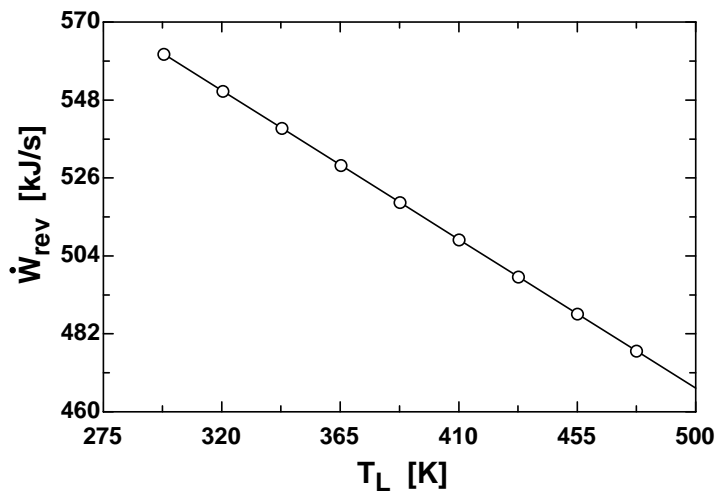

**8-21E** The thermal efficiency and the second-law efficiency of a heat engine are given. The source temperature is to be determined.

**Analysis** From the definition of the second law efficiency,

$$\eta_{II} = \frac{\eta_{th}}{\eta_{th,rev}} \longrightarrow \eta_{th,rev} = \frac{\eta_{th}}{\eta_{II}} = \frac{0.36}{0.60} = 0.60$$

Thus,

$$\eta_{th,rev} = 1 - \frac{T_L}{T_H} \longrightarrow T_H = T_L / (1 - \eta_{th,rev}) = (530 \text{ R}) / 0.40 = \mathbf{1325 \text{ R}}$$

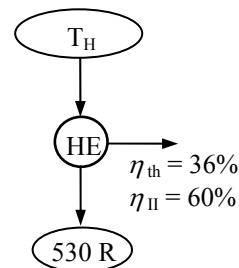

**8-22** A body contains a specified amount of thermal energy at a specified temperature. The amount that can be converted to work is to be determined.

**Analysis** The amount of heat that can be converted to work is simply the amount that a reversible heat engine can convert to work,

$$\eta_{th,rev} = 1 - \frac{T_0}{T_H} = 1 - \frac{298 \text{ K}}{800 \text{ K}} = 0.6275$$

$$\begin{aligned} W_{\max, \text{out}} &= W_{\text{rev, out}} = \eta_{th, \text{rev}} Q_{\text{in}} \\ &= (0.6275)(100 \text{ kJ}) \\ &= \mathbf{62.75 \text{ kJ}} \end{aligned}$$

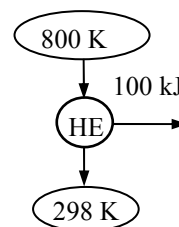

**8-23** The thermal efficiency of a heat engine operating between specified temperature limits is given. The second-law efficiency of an engine is to be determined.

**Analysis** The thermal efficiency of a reversible heat engine operating between the same temperature reservoirs is

$$\eta_{th,rev} = 1 - \frac{T_0}{T_H} = 1 - \frac{293 \text{ K}}{1200 + 273 \text{ K}} = 0.801$$

Thus,

$$\eta_{II} = \frac{\eta_{th}}{\eta_{th,rev}} = \frac{0.40}{0.801} = \mathbf{49.9\%}$$

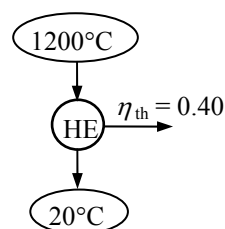

**8-24** A house is maintained at a specified temperature by electric resistance heaters. The reversible work for this heating process and irreversibility are to be determined.

**Analysis** The reversible work is the minimum work required to accomplish this process, and the irreversibility is the difference between the reversible work and the actual electrical work consumed. The actual power input is

$$\dot{W}_{\text{in}} = \dot{Q}_{\text{out}} = \dot{Q}_H = 80,000 \text{ kJ/h} = 22.22 \text{ kW}$$

The COP of a reversible heat pump operating between the specified temperature limits is

$$\text{COP}_{\text{HP,rev}} = \frac{1}{1 - T_L / T_H} = \frac{1}{1 - 288 / 295} = 42.14$$

Thus,

$$\dot{W}_{\text{rev,in}} = \frac{\dot{Q}_H}{\text{COP}_{\text{HP,rev}}} = \frac{22.22 \text{ kW}}{42.14} = \mathbf{0.53 \text{ kW}}$$

and

$$\dot{I} = \dot{W}_{\text{u,in}} - \dot{W}_{\text{rev,in}} = 22.22 - 0.53 = \mathbf{21.69 \text{ kW}}$$

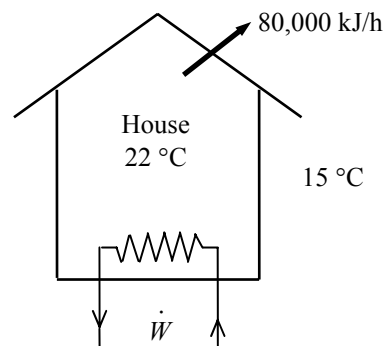

**8-25E** A freezer is maintained at a specified temperature by removing heat from it at a specified rate. The power consumption of the freezer is given. The reversible power, irreversibility, and the second-law efficiency are to be determined.

**Analysis** (a) The reversible work is the minimum work required to accomplish this task, which is the work that a reversible refrigerator operating between the specified temperature limits would consume,

$$\text{COP}_{\text{R,rev}} = \frac{1}{T_H / T_L - 1} = \frac{1}{535 / 480 - 1} = 8.73$$

$$\dot{W}_{\text{rev,in}} = \frac{\dot{Q}_L}{\text{COP}_{\text{R,rev}}} = \frac{75 \text{ Btu/min}}{8.73} \left( \frac{1 \text{ hp}}{42.41 \text{ Btu/min}} \right) = \mathbf{0.20 \text{ hp}}$$

(b) The irreversibility is the difference between the reversible work and the actual electrical work consumed,

$$\dot{I} = \dot{W}_{\text{u,in}} - \dot{W}_{\text{rev,in}} = 0.70 - 0.20 = \mathbf{0.50 \text{ hp}}$$

(c) The second law efficiency is determined from its definition,

$$\eta_{\text{II}} = \frac{\dot{W}_{\text{rev}}}{\dot{W}_{\text{u}}} = \frac{0.20 \text{ hp}}{0.7 \text{ hp}} = \mathbf{28.9\%}$$

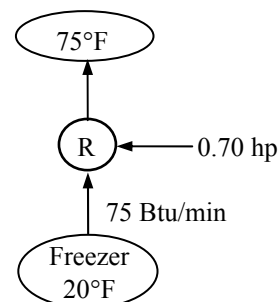



**8-26** It is to be shown that the power produced by a wind turbine is proportional to the cube of the wind velocity and the square of the blade span diameter.

**Analysis** The power produced by a wind turbine is proportional to the kinetic energy of the wind, which is equal to the product of the kinetic energy of air per unit mass and the mass flow rate of air through the blade span area. Therefore,

$$\begin{aligned}\text{Wind power} &= (\text{Efficiency})(\text{Kinetic energy})(\text{Mass flow rate of air}) \\ &= \eta_{\text{wind}} \frac{V^2}{2} (\rho AV) = \eta_{\text{wind}} \frac{V^2}{2} \rho \frac{\pi D^2}{4} V \\ &= \eta_{\text{wind}} \rho \frac{\pi V^3 D^2}{8} = (\text{Constant}) V^3 D^2\end{aligned}$$

which completes the proof that wind power is proportional to the cube of the wind velocity and to the square of the blade span diameter.

**8-27** A geothermal power produces 14 MW power while the exergy destruction in the plant is 18.5 MW. The exergy of the geothermal water entering to the plant, the second-law efficiency of the plant, and the exergy of the heat rejected from the plant are to be determined.

**Assumptions** 1 Steady operating conditions exist. 2 Kinetic and potential energy changes are negligible. 3 Water properties are used for geothermal water.

**Analysis** (a) The properties of geothermal water at the inlet of the plant and at the dead state are (Tables A-4 through A-6)

$$\begin{aligned}T_1 = 160^\circ\text{C} & \left. \begin{array}{l} h_1 = 675.47 \text{ kJ/kg} \\ x_1 = 0 \end{array} \right\} s_1 = 1.9426 \text{ kJ/kg}\cdot\text{K} \\ T_0 = 25^\circ\text{C} & \left. \begin{array}{l} h_0 = 104.83 \text{ kJ/kg} \\ x_0 = 0 \end{array} \right\} s_0 = 0.36723 \text{ kJ/kg}\cdot\text{K}\end{aligned}$$

The exergy of geothermal water entering the plant is

$$\begin{aligned}\dot{X}_{\text{in}} &= \dot{m}[h_1 - h_0 - T_0(s_1 - s_0)] \\ &= (440 \text{ kg/s})[(675.47 - 104.83) \text{ kJ/kg} + 0 - (25 + 273 \text{ K})(1.9426 - 0.36723) \text{ kJ/kg}\cdot\text{K}] \\ &= 44,525 \text{ kW} = \mathbf{44.53 \text{ MW}}\end{aligned}$$

(b) The second-law efficiency of the plant is the ratio of power produced to the exergy input to the plant

$$\eta_{II} = \frac{\dot{W}_{\text{out}}}{\dot{X}_{\text{in}}} = \frac{14,000 \text{ kW}}{44,525 \text{ kW}} = \mathbf{0.314}$$

(c) The exergy of the heat rejected from the plant may be determined from an exergy balance on the plant

$$\dot{X}_{\text{heat,out}} = \dot{X}_{\text{in}} - \dot{W}_{\text{out}} - \dot{X}_{\text{dest}} = 44,525 - 14,000 - 18,500 = 12,025 \text{ kW} = \mathbf{12.03 \text{ MW}}$$

## Second-Law Analysis of Closed Systems

**8-28C** Yes.

**8-29C** Yes, it can. For example, the 1st law efficiency of a reversible heat engine operating between the temperature limits of 300 K and 1000 K is 70%. However, the second law efficiency of this engine, like all reversible devices, is 100%.

**8-30E** Air is expanded in an adiabatic closed system with an isentropic efficiency of 95%. The second law efficiency of the process is to be determined.

**Assumptions** **1** Kinetic and potential energy changes are negligible. **2** The process is adiabatic, and thus there is no heat transfer. **3** Air is an ideal gas with constant specific heats.

**Properties** The properties of air at room temperature are  $c_p = 0.240$  Btu/lbm·R,  $c_v = 0.171$  Btu/lbm·R,  $k = 1.4$ , and  $R = 0.06855$  Btu/lbm·R (Table A-2Ea).

**Analysis** We take the air as the system. This is a *closed system* since no mass crosses the boundaries of the system. The energy balance for this system can be expressed as

$$\underbrace{E_{\text{in}} - E_{\text{out}}}_{\substack{\text{Net energy transfer} \\ \text{by heat, work, and mass}}} = \underbrace{\Delta E_{\text{system}}}_{\substack{\text{Change in internal, kinetic,} \\ \text{potential, etc. energies}}}$$

$$-W_{b,\text{out}} = \Delta U = mc_v(T_2 - T_1)$$

The final temperature for the isentropic case is

$$T_{2s} = T_1 \left( \frac{P_2}{P_1} \right)^{(k-1)/k} = (560 \text{ R}) \left( \frac{15 \text{ psia}}{150 \text{ psia}} \right)^{0.4/1.4} = 290.1 \text{ R}$$

The actual exit temperature from the isentropic relation is

$$\eta = \frac{T_1 - T_2}{T_1 - T_{2s}}$$

$$T_2 = T_1 - \eta(T_1 - T_{2s}) = 560 - (0.95)(560 - 290.1) = 303.6 \text{ R}$$

The boundary work output is

$$w_{b,\text{out}} = c_v(T_1 - T_2) = (0.171 \text{ Btu/lbm} \cdot \text{R})(560 - 303.6) \text{ R} = 43.84 \text{ Btu/lbm}$$

The entropy change of air is

$$\Delta s_{\text{air}} = c_p \ln \frac{T_2}{T_1} - R \ln \frac{P_2}{P_1}$$

$$= (0.240 \text{ Btu/lbm} \cdot \text{R}) \ln \frac{303.6 \text{ R}}{560 \text{ R}} - (0.06855 \text{ Btu/lbm} \cdot \text{R}) \ln \frac{15 \text{ psia}}{150 \text{ psia}}$$

$$= 0.01091 \text{ Btu/lbm} \cdot \text{R}$$

The exergy difference between states 1 and 2 is

$$\phi_1 - \phi_2 = u_1 - u_2 + P_0(u_1 - u_2) - T_0(s_1 - s_2)$$

$$= c_v(T_1 - T_2) + P_0 R \left( \frac{T_1}{P_1} - \frac{T_2}{P_2} \right) - T_0(s_1 - s_2)$$

$$= 43.84 \text{ Btu/lbm} + (14.7 \text{ psia})(0.06855 \text{ Btu/lbm} \cdot \text{R}) \left( \frac{560 \text{ R}}{150 \text{ psia}} - \frac{303.6 \text{ R}}{15 \text{ psia}} \right) - (537 \text{ R})(-0.01091 \text{ Btu/lbm} \cdot \text{R})$$

$$= 33.07 \text{ Btu/lbm}$$

The useful work is determined from

$$w_u = w_{b,\text{out}} - w_{\text{surr}} = c_v(T_1 - T_2) - P_0(u_2 - u_1) = c_v(T_1 - T_2) - P_0 R \left( \frac{T_2}{P_2} - \frac{T_1}{P_1} \right)$$

$$= 43.84 \text{ Btu/lbm} - (14.7 \text{ psia})(0.06855 \text{ Btu/lbm} \cdot \text{R}) \left( \frac{303.6 \text{ R}}{15 \text{ psia}} - \frac{560 \text{ R}}{150 \text{ psia}} \right)$$

$$= 27.21 \text{ Btu/lbm}$$

The second law efficiency is then

$$\eta_{\text{II}} = \frac{w_u}{\Delta \phi} = \frac{27.21 \text{ Btu/lbm}}{33.07 \text{ Btu/lbm}} = \mathbf{0.823}$$

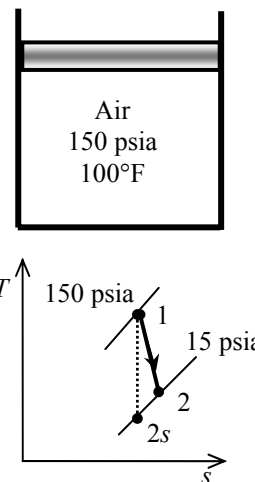

**8-31E** Air and helium at specified states are considered. The gas with the higher exergy content is to be identified.

**Assumptions 1** Kinetic and potential energy changes are negligible. **2** Air and helium are ideal gases with constant specific heats.

**Properties** The properties of air at room temperature are  $c_p = 0.240$  Btu/lbm·R,  $c_v = 0.171$  Btu/lbm·R,  $k = 1.4$ , and  $R = 0.06855$  Btu/lbm·R =  $0.3704$  psia·ft<sup>3</sup>/lbm·R. For helium,  $c_p = 1.25$  Btu/lbm·R,  $c_v = 0.753$  Btu/lbm·R,  $k = 1.667$ , and  $R = 0.4961$  Btu/lbm·R =  $2.6809$  psia·ft<sup>3</sup>/lbm·R. (Table A-2E).

**Analysis** The mass of air in the system is

$$m = \frac{P\mathcal{V}}{RT} = \frac{(100 \text{ psia})(10 \text{ ft}^3)}{(0.3704 \text{ psia} \cdot \text{ft}^3/\text{lbm} \cdot \text{R})(760 \text{ R})} = 3.552 \text{ lbm}$$

Air
10 ft <sup>3</sup>
100 psia
300°F

The entropy change of air between the given state and the dead state is

$$\begin{aligned} s - s_0 &= c_p \ln \frac{T}{T_0} - R \ln \frac{P}{P_0} \\ &= (0.240 \text{ Btu/lbm} \cdot \text{R}) \ln \frac{760 \text{ R}}{537 \text{ R}} - (0.06855 \text{ Btu/lbm} \cdot \text{R}) \ln \frac{100 \text{ psia}}{14.7 \text{ psia}} \\ &= -0.04808 \text{ Btu/lbm} \cdot \text{R} \end{aligned}$$

The air's specific volumes at the given state and dead state are

$$\begin{aligned} \nu &= \frac{RT}{P} = \frac{(0.3704 \text{ psia} \cdot \text{ft}^3/\text{lbm} \cdot \text{R})(760 \text{ R})}{100 \text{ psia}} = 2.815 \text{ ft}^3/\text{lbm} \\ \nu_0 &= \frac{RT_0}{P_0} = \frac{(0.3704 \text{ psia} \cdot \text{ft}^3/\text{lbm} \cdot \text{R})(537 \text{ R})}{14.7 \text{ psia}} = 13.53 \text{ ft}^3/\text{lbm} \end{aligned}$$

The specific closed system exergy of the air is then

$$\begin{aligned} \phi &= u - u_0 + P_0(\nu - \nu_0) - T_0(s - s_0) \\ &= c_v(T - T_0) + P_0(\nu - \nu_0) - T_0(s - s_0) \\ &= (0.171 \text{ Btu/lbm} \cdot \text{R})(300 - 77) \text{ R} + (14.7 \text{ psia})(2.815 - 13.53) \text{ ft}^3/\text{lbm} \left( \frac{1 \text{ Btu}}{5.404 \text{ psia} \cdot \text{ft}^3} \right) \\ &\quad - (537 \text{ R})(-0.04808) \text{ Btu/lbm} \cdot \text{R} \\ &= 34.80 \text{ Btu/lbm} \end{aligned}$$

The total exergy available in the air for the production of work is then

$$\Phi = m\phi = (3.552 \text{ lbm})(34.80 \text{ Btu/lbm}) = \mathbf{123.6 \text{ Btu}}$$

**We now repeat the calculations for helium:**

$$m = \frac{P\mathcal{V}}{RT} = \frac{(80 \text{ psia})(20 \text{ ft}^3)}{(2.6809 \text{ psia} \cdot \text{ft}^3/\text{lbm} \cdot \text{R})(660 \text{ R})} = 0.9043 \text{ lbm}$$

Helium
20 ft <sup>3</sup>
80 psia
200°F

$$\begin{aligned} s - s_0 &= c_p \ln \frac{T}{T_0} - R \ln \frac{P}{P_0} \\ &= (1.25 \text{ Btu/lbm} \cdot \text{R}) \ln \frac{660 \text{ R}}{537 \text{ R}} - (0.4961 \text{ Btu/lbm} \cdot \text{R}) \ln \frac{80 \text{ psia}}{14.7 \text{ psia}} \\ &= -0.5827 \text{ Btu/lbm} \cdot \text{R} \end{aligned}$$

$$\nu = \frac{RT}{P} = \frac{(2.6809 \text{ psia} \cdot \text{ft}^3/\text{lbm} \cdot \text{R})(660 \text{ R})}{80 \text{ psia}} = 22.12 \text{ ft}^3/\text{lbm}$$

$$\nu_0 = \frac{RT_0}{P_0} = \frac{(2.6809 \text{ psia} \cdot \text{ft}^3/\text{lbm} \cdot \text{R})(537 \text{ R})}{14.7 \text{ psia}} = 97.93 \text{ ft}^3/\text{lbm}$$

$$\phi = u - u_0 + P_0(\nu - \nu_0) - T_0(s - s_0)$$

$$= c_\nu(T - T_0) + P_0(\nu - \nu_0) - T_0(s - s_0)$$

$$= (0.753 \text{ Btu/lbm} \cdot \text{R})(200 - 77)\text{R} + (14.7 \text{ psia})(22.12 - 97.93)\text{ft}^3/\text{lbm} \left( \frac{1 \text{ Btu}}{5.404 \text{ psia} \cdot \text{ft}^3} \right)$$

$$- (537 \text{ R})(-0.5827) \text{ Btu/lbm} \cdot \text{R}$$

$$= 199.3 \text{ Btu/lbm}$$

$$\Phi = m\phi = (0.9043 \text{ lbm})(199.3 \text{ Btu/lbm}) = \mathbf{180.2 \text{ Btu}}$$

Comparison of two results shows that the helium system has a greater potential for the production of work.

**8-32** Steam and R-134a at the same states are considered. The fluid with the higher exergy content is to be identified.

**Assumptions** Kinetic and potential energy changes are negligible.

**Analysis** The properties of water at the given state and at the dead state are

$$\left. \begin{array}{l} P = 800 \text{ kPa} \\ T = 180^\circ\text{C} \end{array} \right\} \begin{array}{l} u = 2594.7 \text{ kJ/kg} \\ \nu = 0.24720 \text{ m}^3/\text{kg} \\ s = 6.7155 \text{ kJ/kg} \cdot \text{K} \end{array} \quad (\text{Table A - 6})$$

$$\left. \begin{array}{l} T_0 = 25^\circ\text{C} \\ P_0 = 100 \text{ kPa} \end{array} \right\} \begin{array}{l} u_0 \cong u_f @ 25^\circ\text{C} = 104.83 \text{ kJ/kg} \\ \nu_0 \cong \nu_f @ 25^\circ\text{C} = 0.001003 \text{ m}^3/\text{kg} \\ s_0 \cong s_f @ 25^\circ\text{C} = 0.3672 \text{ kJ/kg} \cdot \text{K} \end{array} \quad (\text{Table A - 4})$$

Steam 1 kg 800 kPa 180°C
-----------------------------------

The exergy of steam is

$$\begin{aligned} \Phi &= m[u - u_0 + P_0(\nu - \nu_0) - T_0(s - s_0)] \\ &= (1 \text{ kg}) \left[ \begin{array}{l} (2594.7 - 104.83) \text{ kJ/kg} + (100 \text{ kPa})(0.24720 - 0.001003) \text{ m}^3/\text{kg} \left( \frac{1 \text{ kJ}}{1 \text{ kPa} \cdot \text{m}^3} \right) \\ - (298 \text{ K})(6.7155 - 0.3672) \text{ kJ/kg} \cdot \text{K} \end{array} \right] \\ &= \mathbf{622.7 \text{ kJ}} \end{aligned}$$

For R-134a;

$$\left. \begin{array}{l} P = 800 \text{ kPa} \\ T = 180^\circ\text{C} \end{array} \right\} \begin{array}{l} u = 386.99 \text{ kJ/kg} \\ \nu = 0.044554 \text{ m}^3/\text{kg} \\ s = 1.3327 \text{ kJ/kg} \cdot \text{K} \end{array} \quad (\text{Table A - 13})$$

$$\left. \begin{array}{l} T_0 = 25^\circ\text{C} \\ P_0 = 100 \text{ kPa} \end{array} \right\} \begin{array}{l} u_0 \cong u_f @ 25^\circ\text{C} = 85.85 \text{ kJ/kg} \\ \nu_0 \cong \nu_f @ 25^\circ\text{C} = 0.0008286 \text{ m}^3/\text{kg} \\ s_0 \cong s_f @ 25^\circ\text{C} = 0.32432 \text{ kJ/kg} \cdot \text{K} \end{array} \quad (\text{Table A - 11})$$

R-134a 1 kg 800 kPa 180°C
------------------------------------

$$\begin{aligned} \Phi &= m[u - u_0 + P_0(\nu - \nu_0) - T_0(s - s_0)] \\ &= (1 \text{ kg}) \left[ \begin{array}{l} (386.99 - 85.85) \text{ kJ/kg} + (100 \text{ kPa})(0.044554 - 0.0008286) \text{ m}^3/\text{kg} \left( \frac{1 \text{ kJ}}{1 \text{ kPa} \cdot \text{m}^3} \right) \\ - (298 \text{ K})(1.3327 - 0.32432) \text{ kJ/kg} \cdot \text{K} \end{array} \right] \\ &= \mathbf{5.02 \text{ kJ}} \end{aligned}$$

The steam can therefore has more work potential than the R-134a.

**8-33** A cylinder initially contains air at atmospheric conditions. Air is compressed to a specified state and the useful work input is measured. The exergy of the air at the initial and final states, and the minimum work input to accomplish this compression process, and the second-law efficiency are to be determined

**Assumptions** **1** Air is an ideal gas with constant specific heats. **2** The kinetic and potential energies are negligible.

**Properties** The gas constant of air is  $R = 0.287 \text{ kPa}\cdot\text{m}^3/\text{kg}\cdot\text{K}$  (Table A-1). The specific heats of air at the average temperature of  $(298+423)/2=360 \text{ K}$  are  $c_p = 1.009 \text{ kJ/kg}\cdot\text{K}$  and  $c_v = 0.722 \text{ kJ/kg}\cdot\text{K}$  (Table A-2).

**Analysis** (a) We realize that  $X_1 = \Phi_1 = \mathbf{0}$  since air initially is at the dead state. The mass of air is

$$m = \frac{P_1 \mathcal{V}_1}{RT_1} = \frac{(100 \text{ kPa})(0.002 \text{ m}^3)}{(0.287 \text{ kPa}\cdot\text{m}^3/\text{kg}\cdot\text{K})(298 \text{ K})} = 0.00234 \text{ kg}$$

Also,

$$\frac{P_2 \mathcal{V}_2}{T_2} = \frac{P_1 \mathcal{V}_1}{T_1} \longrightarrow \mathcal{V}_2 = \frac{P_1 T_2}{P_2 T_1} \mathcal{V}_1 = \frac{(100 \text{ kPa})(423 \text{ K})}{(600 \text{ kPa})(298 \text{ K})} (2 \text{ L}) = 0.473 \text{ L}$$

and

$$\begin{aligned} s_2 - s_0 &= c_{p,\text{avg}} \ln \frac{T_2}{T_0} - R \ln \frac{P_2}{P_0} \\ &= (1.009 \text{ kJ/kg}\cdot\text{K}) \ln \frac{423 \text{ K}}{298 \text{ K}} - (0.287 \text{ kJ/kg}\cdot\text{K}) \ln \frac{600 \text{ kPa}}{100 \text{ kPa}} \\ &= -0.1608 \text{ kJ/kg}\cdot\text{K} \end{aligned}$$

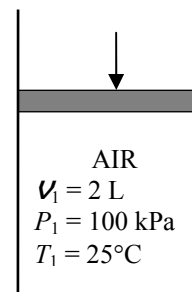

Thus, the exergy of air at the final state is

$$\begin{aligned} X_2 &= \Phi_2 = m \left[ c_{v,\text{avg}} (T_2 - T_0) - T_0 (s_2 - s_0) \right] + P_0 (\mathcal{V}_2 - \mathcal{V}_0) \\ &= (0.00234 \text{ kg}) \left[ (0.722 \text{ kJ/kg}\cdot\text{K})(423 - 298) \text{ K} - (298 \text{ K})(-0.1608 \text{ kJ/kg}\cdot\text{K}) \right] \\ &\quad + (100 \text{ kPa})(0.000473 - 0.002) \text{ m}^3 [\text{kJ/m}^3 \cdot \text{kPa}] \\ &= \mathbf{0.171 \text{ kJ}} \end{aligned}$$

(b) The minimum work input is the reversible work input, which can be determined from the exergy balance by setting the exergy destruction equal to zero,

$$\begin{aligned} \underbrace{X_{\text{in}} - X_{\text{out}}}_{\text{Net exergy transfer by heat, work, and mass}} - \underbrace{X_{\text{destroyed}}}_{\text{Exergy destruction}} \stackrel{\approx 0 \text{ (reversible)}}{=} \underbrace{\Delta X_{\text{system}}}_{\text{Change in exergy}} \\ W_{\text{rev,in}} = X_2 - X_1 \\ = 0.171 - 0 = \mathbf{0.171 \text{ kJ}} \end{aligned}$$

(c) The second-law efficiency of this process is

$$\eta_{\text{II}} = \frac{W_{\text{rev,in}}}{W_{\text{u,in}}} = \frac{0.171 \text{ kJ}}{1.2 \text{ kJ}} = \mathbf{14.3\%}$$

**8-34** A cylinder is initially filled with R-134a at a specified state. The refrigerant is cooled and condensed at constant pressure. The exergy of the refrigerant at the initial and final states, and the exergy destroyed during this process are to be determined.

**Assumptions** The kinetic and potential energies are negligible.

**Properties** From the refrigerant tables (Tables A-11 through A-13),

$$\left. \begin{array}{l} P_1 = 0.7 \text{ MPa} \\ T_1 = 60^\circ\text{C} \end{array} \right\} \begin{array}{l} \nu_1 = 0.034875 \text{ m}^3 / \text{kg} \\ u_1 = 274.01 \text{ kJ/kg} \\ s_1 = 1.0256 \text{ kJ/kg} \cdot \text{K} \end{array}$$

$$\left. \begin{array}{l} P_2 = 0.7 \text{ MPa} \\ T_2 = 24^\circ\text{C} \end{array} \right\} \begin{array}{l} \nu_2 \cong \nu_{f@24^\circ\text{C}} = 0.0008261 \text{ m}^3 / \text{kg} \\ u_2 \cong u_{f@24^\circ\text{C}} = 84.44 \text{ kJ/kg} \\ s_2 \cong s_{f@24^\circ\text{C}} = 0.31958 \text{ kJ/kg} \cdot \text{K} \end{array}$$

$$\left. \begin{array}{l} P_0 = 0.1 \text{ MPa} \\ T_0 = 24^\circ\text{C} \end{array} \right\} \begin{array}{l} \nu_0 = 0.23718 \text{ m}^3 / \text{kg} \\ u_0 = 251.84 \text{ kJ/kg} \\ s_0 = 1.1033 \text{ kJ/kg} \cdot \text{K} \end{array}$$

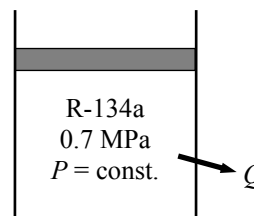

**Analysis** (a) From the closed system exergy relation,

$$\begin{aligned} X_1 &= \Phi_1 = m\{(u_1 - u_0) - T_0(s_1 - s_0) + P_0(\nu_1 - \nu_0)\} \\ &= (5 \text{ kg})\{(274.01 - 251.84) \text{ kJ/kg} - (297 \text{ K})(1.0256 - 1.1033) \text{ kJ/kg} \cdot \text{K} \\ &\quad + (100 \text{ kPa})(0.034875 - 0.23718) \text{ m}^3/\text{kg} \left( \frac{1 \text{ kJ}}{1 \text{ kPa} \cdot \text{m}^3} \right)\} \\ &= \mathbf{125.1 \text{ kJ}} \end{aligned}$$

and,

$$\begin{aligned} X_2 &= \Phi_2 = m\{(u_2 - u_0) - T_0(s_2 - s_0) + P_0(\nu_2 - \nu_0)\} \\ &= (5 \text{ kg})\{(84.44 - 251.84) \text{ kJ/kg} - (297 \text{ K})(0.31958 - 1.1033) \text{ kJ/kg} \cdot \text{K} \\ &\quad + (100 \text{ kPa})(0.0008261 - 0.23718) \text{ m}^3/\text{kg} \left( \frac{1 \text{ kJ}}{1 \text{ kPa} \cdot \text{m}^3} \right)\} \\ &= \mathbf{208.6 \text{ kJ}} \end{aligned}$$

(b) The reversible work input, which represents the minimum work input  $W_{\text{rev,in}}$  in this case can be determined from the exergy balance by setting the exergy destruction equal to zero,

$$\underbrace{X_{\text{in}} - X_{\text{out}}}_{\text{Net exergy transfer by heat, work, and mass}} - \underbrace{X_{\text{destroyed}}^{\neq 0 \text{ (reversible)}}}_{\text{Exergy destruction}} = \underbrace{\Delta X_{\text{system}}}_{\text{Change in exergy}}$$

$$W_{\text{rev,in}} = X_2 - X_1 = 208.6 - 125.1 = 83.5 \text{ kJ}$$

Noting that the process involves only boundary work, the useful work input during this process is simply the boundary work in excess of the work done by the surrounding air,

$$\begin{aligned} W_{\text{u,in}} &= W_{\text{in}} - W_{\text{surr,in}} = W_{\text{in}} - P_0(\nu_1 - \nu_2) = P(\nu_1 - \nu_2) - P_0m(\nu_1 - \nu_2) \\ &= m(P - P_0)(\nu_1 - \nu_2) \\ &= (5 \text{ kg})(700 - 100 \text{ kPa})(0.034875 - 0.0008261 \text{ m}^3 / \text{kg}) \left( \frac{1 \text{ kJ}}{1 \text{ kPa} \cdot \text{m}^3} \right) = 102.1 \text{ kJ} \end{aligned}$$

Knowing both the actual useful and reversible work inputs, the exergy destruction or irreversibility that is the difference between the two is determined from its definition to be

$$X_{\text{destroyed}} = I = W_{\text{u,in}} - W_{\text{rev,in}} = 102.1 - 83.5 = \mathbf{18.6 \text{ kJ}}$$



**8-35E** An insulated rigid tank contains saturated liquid-vapor mixture of water at a specified pressure. An electric heater inside is turned on and kept on until all the liquid is vaporized. The exergy destruction and the second-law efficiency are to be determined.

**Assumptions** Kinetic and potential energies are negligible.

**Properties** From the steam tables (Tables A-4 through A-6)

$$P_1 = 35 \text{ psia} \left\{ \begin{array}{l} v_1 = v_f + x_1 v_{fg} = 0.01708 + 0.25 \times (11.901 - 0.01708) = 2.9880 \text{ ft}^3 / \text{lbm} \\ u_1 = u_f + x_1 u_{fg} = 227.92 + 0.25 \times 862.19 = 443.47 \text{ Btu} / \text{lbm} \\ s_1 = s_f + x_1 s_{fg} = 0.38093 + 0.25 \times 1.30632 = 0.70751 \text{ Btu} / \text{lbm} \cdot \text{R} \end{array} \right.$$

$$\left. \begin{array}{l} v_2 = v_1 \\ \text{sat. vapor} \end{array} \right\} \begin{array}{l} u_2 = u_g @ v_g = 2.9880 \text{ ft}^3 / \text{lbm} = 1110.9 \text{ Btu} / \text{lbm} \\ s_2 = s_g @ v_g = 2.9880 \text{ ft}^3 / \text{lbm} = 1.5692 \text{ Btu} / \text{lbm} \cdot \text{R} \end{array}$$

**Analysis** (a) The irreversibility can be determined from its definition  $X_{\text{destroyed}} = T_0 S_{\text{gen}}$  where the entropy generation is determined from an entropy balance on the tank, which is an insulated closed system,

$$\underbrace{S_{\text{in}} - S_{\text{out}}}_{\text{Net entropy transfer by heat and mass}} + \underbrace{S_{\text{gen}}}_{\text{Entropy generation}} = \underbrace{\Delta S_{\text{system}}}_{\text{Change in entropy}}$$

$$S_{\text{gen}} = \Delta S_{\text{system}} = m(s_2 - s_1)$$

Substituting,

$$\begin{aligned} X_{\text{destroyed}} &= T_0 S_{\text{gen}} = m T_0 (s_2 - s_1) \\ &= (6 \text{ lbm})(535 \text{ R})(1.5692 - 0.70751) \text{ Btu} / \text{lbm} \cdot \text{R} = \mathbf{2766 \text{ Btu}} \end{aligned}$$

(b) Noting that  $V = \text{constant}$  during this process, the  $W$  and  $W_u$  are identical and are determined from the energy balance on the closed system energy equation,

$$\underbrace{E_{\text{in}} - E_{\text{out}}}_{\text{Net energy transfer by heat, work, and mass}} = \underbrace{\Delta E_{\text{system}}}_{\text{Change in internal, kinetic, potential, etc. energies}}$$

$$W_{\text{e,in}} = \Delta U = m(u_2 - u_1)$$

or,

$$W_{\text{e,in}} = (6 \text{ lbm})(1110.9 - 443.47) \text{ Btu} / \text{lbm} = 4005 \text{ Btu}$$

Then the reversible work during this process and the second-law efficiency become

$$W_{\text{rev,in}} = W_{\text{u,in}} - X_{\text{destroyed}} = 4005 - 2766 = 1239 \text{ Btu}$$

Thus,

$$\eta_{\text{II}} = \frac{W_{\text{rev}}}{W_u} = \frac{1239 \text{ Btu}}{4005 \text{ Btu}} = \mathbf{30.9\%}$$

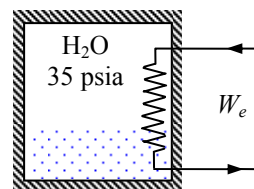

**8-36** A rigid tank is divided into two equal parts by a partition. One part is filled with compressed liquid while the other side is evacuated. The partition is removed and water expands into the entire tank. The exergy destroyed during this process is to be determined.

**Assumptions** Kinetic and potential energies are negligible.

**Analysis** The properties of the water are (Tables A-4 through A-6)

$$\begin{array}{l}
 P_1 = 300 \text{ kPa} \\
 T_1 = 60^\circ\text{C}
 \end{array}
 \left\{
 \begin{array}{l}
 \nu_1 \cong \nu_f @ 60^\circ\text{C} = 0.001017 \text{ m}^3 / \text{kg} \\
 u_1 \cong u_f @ 60^\circ\text{C} = 251.16 \text{ kJ/kg} \\
 s_1 \cong s_f @ 60^\circ\text{C} = 0.8313 \text{ kJ/kg} \cdot \text{K}
 \end{array}
 \right.$$

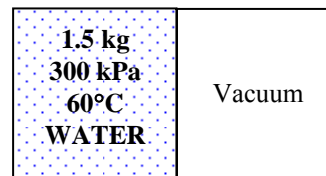

Noting that  $\nu_2 = 2\nu_1 = 2 \times 0.001017 = 0.002034 \text{ m}^3 / \text{kg}$ ,

$$\begin{array}{l}
 P_2 = 15 \text{ kPa} \\
 \nu_2 = 0.002034
 \end{array}
 \left\{
 \begin{array}{l}
 x_2 = \frac{\nu_2 - \nu_f}{\nu_{fg}} = \frac{0.002034 - 0.001014}{10.02 - 0.001014} = 0.0001017 \\
 u_2 = u_f + x_2 u_{fg} = 225.93 + 0.0001017 \times 2222.1 = 226.15 \text{ kJ/kg} \\
 s_2 = s_f + x_2 s_{fg} = 0.7549 + 0.0001017 \times 7.2522 = 0.7556 \text{ kJ/kg} \cdot \text{K}
 \end{array}
 \right.$$

Taking the direction of heat transfer to be *to* the tank, the energy balance on this closed system becomes

$$\underbrace{E_{\text{in}} - E_{\text{out}}}_{\substack{\text{Net energy transfer} \\ \text{by heat, work, and mass}}} = \underbrace{\Delta E_{\text{system}}}_{\substack{\text{Change in internal, kinetic,} \\ \text{potential, etc. energies}}}$$

$$Q_{\text{in}} = \Delta U = m(u_2 - u_1)$$

or,

$$Q_{\text{in}} = (1.5 \text{ kg})(226.15 - 251.16) \text{ kJ/kg} = -37.51 \text{ kJ} \rightarrow Q_{\text{out}} = 37.51 \text{ kJ}$$

The irreversibility can be determined from its definition  $X_{\text{destroyed}} = T_0 S_{\text{gen}}$  where the entropy generation is determined from an entropy balance on an *extended system* that includes the tank and its immediate surroundings so that the boundary temperature of the extended system is the temperature of the surroundings at all times,

$$\underbrace{S_{\text{in}} - S_{\text{out}}}_{\substack{\text{Net entropy transfer} \\ \text{by heat and mass}}} + \underbrace{S_{\text{gen}}}_{\substack{\text{Entropy} \\ \text{generation}}} = \underbrace{\Delta S_{\text{system}}}_{\substack{\text{Change} \\ \text{in entropy}}}$$

$$-\frac{Q_{\text{out}}}{T_{\text{b,out}}} + S_{\text{gen}} = \Delta S_{\text{system}} = m(s_2 - s_1)$$

$$S_{\text{gen}} = m(s_2 - s_1) + \frac{Q_{\text{out}}}{T_{\text{surr}}}$$

Substituting,

$$\begin{aligned}
 X_{\text{destroyed}} &= T_0 S_{\text{gen}} = T_0 \left( m(s_2 - s_1) + \frac{Q_{\text{out}}}{T_{\text{surr}}} \right) \\
 &= (298 \text{ K}) \left[ (1.5 \text{ kg})(0.7556 - 0.8313) \text{ kJ/kg} \cdot \text{K} + \frac{37.51 \text{ kJ}}{298 \text{ K}} \right] \\
 &= \mathbf{3.67 \text{ kJ}}
 \end{aligned}$$

**8-37 EES** Problem 8-36 is reconsidered. The effect of final pressure in the tank on the exergy destroyed during the process is to be investigated.

**Analysis** The problem is solved using EES, and the solution is given below.

```
T_1=60 [C]
P_1=300 [kPa]
m=1.5 [kg]
P_2=15 [kPa]
T_o=25 [C]
P_o=100 [kPa]
T_surr = T_o
```

"Conservation of energy for closed system is:"

```
E_in - E_out = DELTAE
DELTA E = m*(u_2 - u_1)
E_in=0
E_out= Q_out
u_1 =intenergy(steam_iapws,P=P_1,T=T_1)
v_1 =volume(steam_iapws,P=P_1,T=T_1)
s_1 =entropy(steam_iapws,P=P_1,T=T_1)
v_2 = 2*v_1
u_2 = intenergy(steam_iapws, v=v_2,P=P_2)
s_2 = entropy(steam_iapws, v=v_2,P=P_2)
S_in -S_out+S_gen=DELTAS_sys
S_in=0 [kJ/K]
S_out=Q_out/(T_surr+273)
DELTAS_sys=m*(s_2 - s_1)
X_destroyed = (T_o+273)*S_gen
```

P <sub>2</sub> [kPa]	X <sub>destroyed</sub> [kJ]	Q <sub>out</sub> [kJ]
15	3.666	37.44
16.11	2.813	28.07
17.22	1.974	19.25
18.33	1.148	10.89
19.44	0.336	2.95
20.56	-0.4629	-4.612
21.67	-1.249	-11.84
22.78	-2.022	-18.75
23.89	-2.782	-25.39
25	-3.531	-31.77

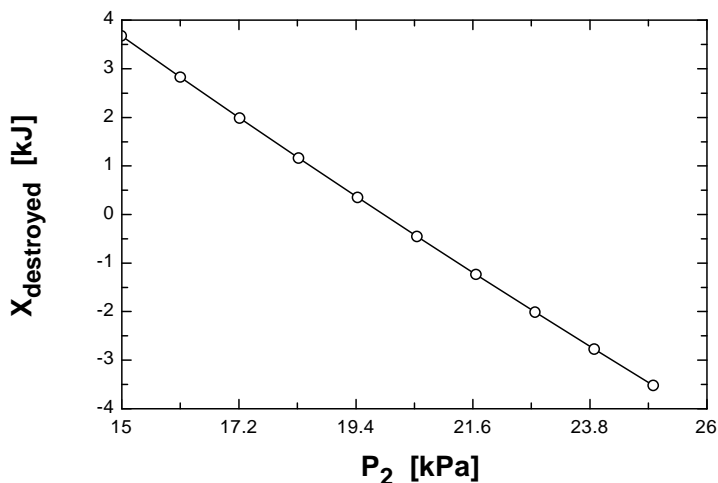

**8-38** An insulated cylinder is initially filled with saturated liquid water at a specified pressure. The water is heated electrically at constant pressure. The minimum work by which this process can be accomplished and the exergy destroyed are to be determined.

**Assumptions 1** The kinetic and potential energy changes are negligible. **2** The cylinder is well-insulated and thus heat transfer is negligible. **3** The thermal energy stored in the cylinder itself is negligible. **4** The compression or expansion process is quasi-equilibrium.

**Analysis** (a) From the steam tables (Tables A-4 through A-6),

$$P_1 = 150 \text{ kPa} \left. \begin{array}{l} u_1 = u_{f@150 \text{ kPa}} = 466.97 \text{ kJ/kg} \\ \nu_1 = \nu_{f@150 \text{ kPa}} = 0.001053 \text{ m}^3/\text{kg} \\ h_1 = h_{f@150 \text{ kPa}} = 467.13 \text{ kJ/kg} \\ s_1 = s_{f@150 \text{ kPa}} = 1.4337 \text{ kJ/kg} \cdot \text{K} \end{array} \right\} \text{sat. liquid}$$

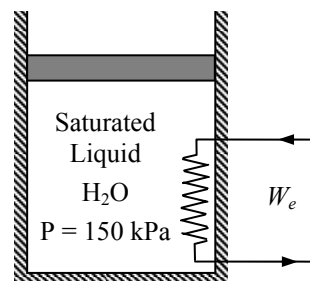

The mass of the steam is

$$m = \frac{\nu}{\nu_1} = \frac{0.002 \text{ m}^3}{0.001053 \text{ m}^3/\text{kg}} = 1.899 \text{ kg}$$

We take the contents of the cylinder as the system. This is a closed system since no mass enters or leaves. The energy balance for this stationary closed system can be expressed as

$$\underbrace{E_{\text{in}} - E_{\text{out}}}_{\text{Net energy transfer by heat, work, and mass}} = \underbrace{\Delta E_{\text{system}}}_{\text{Change in internal, kinetic, potential, etc. energies}}$$

$$W_{e,\text{in}} - W_{b,\text{out}} = \Delta U$$

$$W_{e,\text{in}} = m(h_2 - h_1)$$

since  $\Delta U + W_b = \Delta H$  during a constant pressure quasi-equilibrium process. Solving for  $h_2$ ,

$$h_2 = h_1 + \frac{W_{e,\text{in}}}{m} = 467.13 + \frac{2200 \text{ kJ}}{1.899 \text{ kg}} = 1625.1 \text{ kJ/kg}$$

Thus,

$$\left. \begin{array}{l} P_2 = 150 \text{ kPa} \\ h_2 = 1625.1 \text{ kJ/kg} \end{array} \right\} \begin{array}{l} x_2 = \frac{h_2 - h_f}{h_{fg}} = \frac{1625.1 - 467.13}{2226.0} = 0.5202 \\ s_2 = s_f + x_2 s_{fg} = 1.4337 + 0.5202 \times 5.7894 = 4.4454 \text{ kJ/kg} \cdot \text{K} \\ u_2 = u_f + x_2 u_{fg} = 466.97 + 0.5202 \times 2052.3 = 1534.6 \text{ kJ/kg} \\ \nu_2 = \nu_f + x_2 \nu_{fg} = 0.001053 + 0.5202 \times (1.1594 - 0.001053) = 0.6037 \text{ m}^3/\text{kg} \end{array}$$

The reversible work input, which represents the minimum work input  $W_{\text{rev,in}}$  in this case can be determined from the exergy balance by setting the exergy destruction equal to zero,

$$\underbrace{X_{\text{in}} - X_{\text{out}}}_{\text{Net exergy transfer by heat, work, and mass}} - \underbrace{X_{\text{destroyed}}}_{\text{Exergy destruction}} \stackrel{=0 \text{ (reversible)}}{=} \underbrace{\Delta X_{\text{system}}}_{\text{Change in exergy}} \rightarrow W_{\text{rev,in}} = X_2 - X_1$$

Substituting the closed system exergy relation, the reversible work input during this process is determined to be

$$\begin{aligned}
 W_{\text{rev,in}} &= -m[(u_1 - u_2) - T_0(s_1 - s_2) + P_0(v_1 - v_2)] \\
 &= -(1.899 \text{ kg})\{(466.97 - 1534.6) \text{ kJ/kg} - (298 \text{ K})(1.4337 - 4.4454) \text{ kJ/kg} \cdot \text{K} \\
 &\quad + (100 \text{ kPa})(0.001053 - 0.6037) \text{ m}^3 / \text{kg}[1 \text{ kJ/1 kPa} \cdot \text{m}^3]\} \\
 &= \mathbf{437.7 \text{ kJ}}
 \end{aligned}$$

(b) The exergy destruction (or irreversibility) associated with this process can be determined from its definition  $X_{\text{destroyed}} = T_0 S_{\text{gen}}$  where the entropy generation is determined from an entropy balance on the cylinder, which is an insulated closed system,

$$\begin{array}{c}
 \underbrace{S_{\text{in}} - S_{\text{out}}}_{\text{Net entropy transfer}} + \underbrace{S_{\text{gen}}}_{\text{Entropy}} = \underbrace{\Delta S_{\text{system}}}_{\text{Change}} \\
 \text{by heat and mass} \quad \text{generation} \quad \text{in entropy} \\
 S_{\text{gen}} = \Delta S_{\text{system}} = m(s_2 - s_1)
 \end{array}$$

Substituting,

$$X_{\text{destroyed}} = T_0 S_{\text{gen}} = mT_0(s_2 - s_1) = (298 \text{ K})(1.899 \text{ kg})(4.4454 - 1.4337) \text{ kJ/kg} \cdot \text{K} = \mathbf{1705 \text{ kJ}}$$

**8-39 EES** Problem 8-38 is reconsidered. The effect of the amount of electrical work on the minimum work and the exergy destroyed is to be investigated.

**Analysis** The problem is solved using EES, and the solution is given below.

```
x_1=0
P_1=150 [kPa]
V=2 [L]
P_2=P_1
{W_Ele = 2200 [kJ]}
T_o=25 [C]
P_o=100 [kPa]
```

"Conservation of energy for closed system is:"

```
E_in - E_out = DELTA E
DELTA E = m*(u_2 - u_1)
E_in=W_Ele
E_out= W_b
W_b = m*P_1*(v_2-v_1)
u_1 =intenergy(steam_iapws,P=P_1,x=x_1)
v_1 =volume(steam_iapws,P=P_1,x=x_1)
s_1 =entropy(steam_iapws,P=P_1,x=x_1)
u_2 = intenergy(steam_iapws, v=v_2,P=P_2)
s_2 = entropy(steam_iapws, v=v_2,P=P_2)
m=V*convert(L,m^3)/v_1
W_rev_in=m*(u_2 - u_1 -(T_o+273.15)
*(s_2-s_1)+P_o*(v_2-v_1))
```

"Entropy Balance:"

```
S_in - S_out+S_gen = DELTA S_sys
DELTA S_sys = m*(s_2 - s_1)
S_in=0 [kJ/K]
S_out= 0 [kJ/K]
```

"The exergy destruction or irreversibility is:"

```
X_destroyed = (T_o+273.15)*S_gen
```

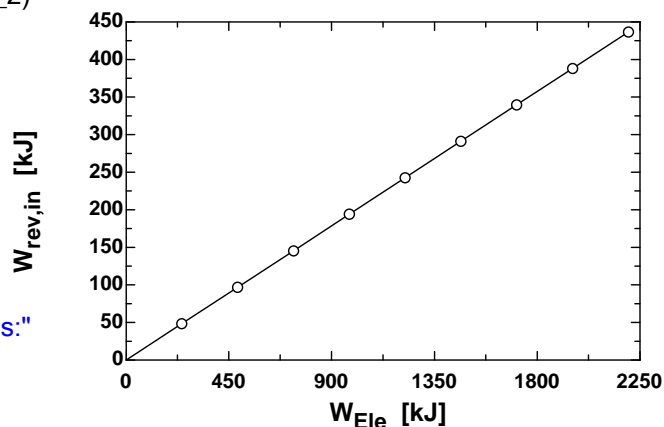

W <sub>Ele</sub> [kJ]	W <sub>rev,in</sub> [kJ]	X <sub>destroyed</sub> [kJ]
0	0	0
244.4	48.54	189.5
488.9	97.07	379.1
733.3	145.6	568.6
977.8	194.1	758.2
1222	242.7	947.7
1467	291.2	1137
1711	339.8	1327
1956	388.3	1516
2200	436.8	1706

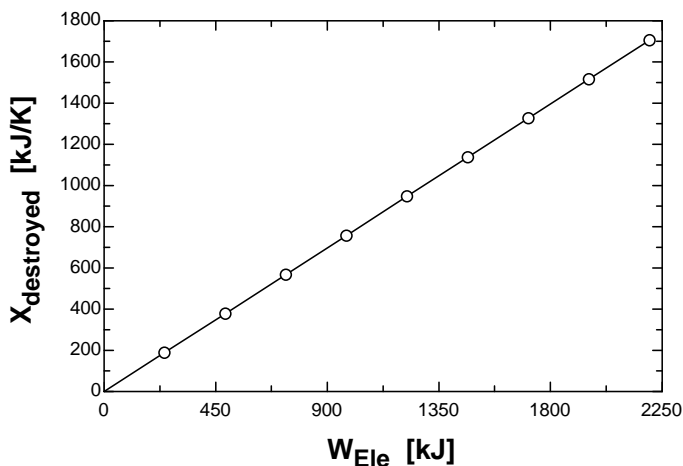

**8-40** An insulated cylinder is initially filled with saturated R-134a vapor at a specified pressure. The refrigerant expands in a reversible manner until the pressure drops to a specified value. The change in the exergy of the refrigerant during this process and the reversible work are to be determined.

**Assumptions 1** The kinetic and potential energy changes are negligible. **2** The cylinder is well-insulated and thus heat transfer is negligible. **3** The thermal energy stored in the cylinder itself is negligible. **4** The process is stated to be reversible.

**Analysis** This is a reversible adiabatic (i.e., isentropic) process, and thus  $s_2 = s_1$ . From the refrigerant tables (Tables A-11 through A-13),

$$P_1 = 0.8 \text{ MPa} \left. \begin{array}{l} \nu_1 = \nu_{g@0.8 \text{ MPa}} = 0.02562 \text{ m}^3 / \text{kg} \\ u_1 = u_{g@0.8 \text{ MPa}} = 246.79 \text{ kJ/kg} \\ s_1 = s_{g@0.8 \text{ MPa}} = 0.9183 \text{ kJ/kg} \cdot \text{K} \end{array} \right\} \text{ sat. vapor}$$

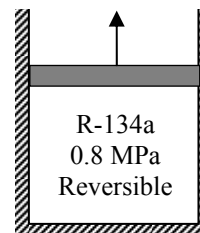

The mass of the refrigerant is

$$m = \frac{V}{\nu_1} = \frac{0.05 \text{ m}^3}{0.02562 \text{ m}^3 / \text{kg}} = 1.952 \text{ kg}$$

$$P_2 = 0.2 \text{ MPa} \left. \begin{array}{l} x_2 = \frac{s_2 - s_f}{s_{fg}} = \frac{0.9183 - 0.15457}{0.78316} = 0.9753 \\ \nu_2 = \nu_f + x_2 \nu_{fg} = 0.0007533 + 0.9753 \times (0.099867 - 0.0007533) = 0.09741 \text{ m}^3 / \text{kg} \\ u_2 = u_f + x_2 u_{fg} = 38.28 + 0.9753 \times 186.21 = 219.88 \text{ kJ/kg} \end{array} \right\} s_2 = s_1$$

The reversible work output, which represents the maximum work output  $W_{\text{rev,out}}$  can be determined from the exergy balance by setting the exergy destruction equal to zero,

$$\underbrace{X_{\text{in}} - X_{\text{out}}}_{\text{Net exergy transfer by heat, work, and mass}} - \underbrace{X_{\text{destroyed}}^{\phi_0 \text{ (reversible)}}}_{\text{Exergy destruction}} = \underbrace{\Delta X_{\text{system}}}_{\text{Change in exergy}}$$

$$-W_{\text{rev,out}} = X_2 - X_1$$

$$W_{\text{rev,out}} = X_1 - X_2$$

$$= \Phi_1 - \Phi_2$$

Therefore, the change in exergy and the reversible work are identical in this case. Using the definition of the closed system exergy and substituting, the reversible work is determined to be

$$W_{\text{rev,out}} = \Phi_1 - \Phi_2 = m \left[ (u_1 - u_2) - T_0 (s_1 - s_2) + P_0 (\nu_1 - \nu_2) \right] = m \left[ (u_1 - u_2) + P_0 (\nu_1 - \nu_2) \right]$$

$$= (1.952 \text{ kg}) [(246.79 - 219.88) \text{ kJ/kg} + (100 \text{ kPa})(0.02562 - 0.09741) \text{ m}^3 / \text{kg} [\text{kJ/kPa} \cdot \text{m}^3]]$$

$$= \mathbf{38.5 \text{ kJ}}$$

**8-41E** Oxygen gas is compressed from a specified initial state to a final specified state. The reversible work and the increase in the exergy of the oxygen during this process are to be determined.

**Assumptions** At specified conditions, oxygen can be treated as an ideal gas with constant specific heats.

**Properties** The gas constant of oxygen is  $R = 0.06206$  Btu/lbm·R (Table A-1E). The constant-volume specific heat of oxygen at the average temperature is

$$T_{\text{avg}} = (T_1 + T_2) / 2 = (75 + 525) / 2 = 300^\circ\text{F} \longrightarrow c_{v,\text{avg}} = 0.164 \text{ Btu/lbm} \cdot \text{R}$$

**Analysis** The entropy change of oxygen is

$$\begin{aligned} s_2 - s_1 &= c_{v,\text{avg}} \ln\left(\frac{T_2}{T_1}\right) + R \ln\left(\frac{v_2}{v_1}\right) \\ &= (0.164 \text{ Btu/lbm} \cdot \text{R}) \ln\left(\frac{985 \text{ R}}{535 \text{ R}}\right) + (0.06206 \text{ Btu/lbm} \cdot \text{R}) \ln\left(\frac{1.5 \text{ ft}^3/\text{lbm}}{12 \text{ ft}^3/\text{lbm}}\right) \\ &= -0.02894 \text{ Btu/lbm} \cdot \text{R} \end{aligned}$$

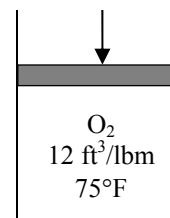

The reversible work input, which represents the minimum work input  $W_{\text{rev,in}}$  in this case can be determined from the exergy balance by setting the exergy destruction equal to zero,

$$\underbrace{X_{\text{in}} - X_{\text{out}}}_{\text{Net exergy transfer by heat, work, and mass}} - \underbrace{X_{\text{destroyed}}^{\text{reversible}}}_{\text{Exergy destruction}} = \underbrace{\Delta X_{\text{system}}}_{\text{Change in exergy}} \rightarrow W_{\text{rev,in}} = X_2 - X_1$$

Therefore, the change in exergy and the reversible work are identical in this case. Substituting the closed system exergy relation, the reversible work input during this process is determined to be

$$\begin{aligned} w_{\text{rev,in}} &= \phi_2 - \phi_1 = -[(u_1 - u_2) - T_0(s_1 - s_2) + P_0(v_1 - v_2)] \\ &= -\{(0.164 \text{ Btu/lbm} \cdot \text{R})(535 - 985)\text{R} - (535 \text{ R})(0.02894 \text{ Btu/lbm} \cdot \text{R}) \\ &\quad + (14.7 \text{ psia})(12 - 1.5)\text{ft}^3/\text{lbm}[\text{Btu}/5.4039 \text{ psia} \cdot \text{ft}^3]\} \\ &= \mathbf{60.7 \text{ Btu/lbm}} \end{aligned}$$

Also, the increase in the exergy of oxygen is

$$\phi_2 - \phi_1 = w_{\text{rev,in}} = \mathbf{60.7 \text{ Btu/lbm}}$$



**8-42** An insulated tank contains CO<sub>2</sub> gas at a specified pressure and volume. A paddle-wheel in the tank stirs the gas, and the pressure and temperature of CO<sub>2</sub> rises. The actual paddle-wheel work and the minimum paddle-wheel work by which this process can be accomplished are to be determined.

**Assumptions 1** At specified conditions, CO<sub>2</sub> can be treated as an ideal gas with constant specific heats at the average temperature. **2** The surroundings temperature is 298 K.

**Analysis** (a) The initial and final temperature of CO<sub>2</sub> are

$$T_1 = \frac{P_1 \mathcal{V}_1}{mR} = \frac{(100 \text{ kPa})(1.2 \text{ m}^3)}{(2.13 \text{ kg})(0.1889 \text{ kPa} \cdot \text{m}^3 / \text{kg} \cdot \text{K})} = 298.2 \text{ K}$$

$$T_2 = \frac{P_2 \mathcal{V}_2}{mR} = \frac{(120 \text{ kPa})(1.2 \text{ m}^3)}{(2.13 \text{ kg})(0.1889 \text{ kPa} \cdot \text{m}^3 / \text{kg} \cdot \text{K})} = 357.9 \text{ K}$$

$$T_{\text{avg}} = (T_1 + T_2) / 2 = (298.2 + 357.9) / 2 = 328 \text{ K} \longrightarrow c_{\nu, \text{avg}} = 0.684 \text{ kJ/kg} \cdot \text{K}$$

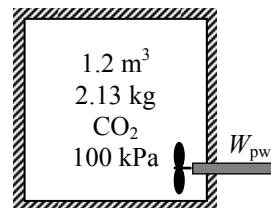

The actual paddle-wheel work done is determined from the energy balance on the CO gas in the tank,

We take the contents of the cylinder as the system. This is a closed system since no mass enters or leaves. The energy balance for this stationary closed system can be expressed as

$$\underbrace{E_{\text{in}} - E_{\text{out}}}_{\text{Net energy transfer by heat, work, and mass}} = \underbrace{\Delta E_{\text{system}}}_{\text{Change in internal, kinetic, potential, etc. energies}}$$

$$W_{\text{pw, in}} = \Delta U = mc_{\nu}(T_2 - T_1)$$

or,

$$W_{\text{pw, in}} = (2.13 \text{ kg})(0.684 \text{ kJ/kg} \cdot \text{K})(357.9 - 298.2) \text{ K} = \mathbf{87.0 \text{ kJ}}$$

(b) The minimum paddle-wheel work with which this process can be accomplished is the reversible work, which can be determined from the exergy balance by setting the exergy destruction equal to zero,

$$\underbrace{X_{\text{in}} - X_{\text{out}}}_{\text{Net exergy transfer by heat, work, and mass}} - \underbrace{X_{\text{destroyed}}}_{\substack{\text{Exergy} \\ \text{destruction}}} \stackrel{\approx 0 \text{ (reversible)}}{=} \underbrace{\Delta X_{\text{system}}}_{\text{Change in exergy}} \rightarrow W_{\text{rev, in}} = X_2 - X_1$$

Substituting the closed system exergy relation, the reversible work input for this process is determined to be

$$\begin{aligned} W_{\text{rev, in}} &= m \left[ (u_2 - u_1) - T_0 (s_2 - s_1) + P_0 (\mathcal{V}_2^{\text{sp}0} - \mathcal{V}_1) \right] \\ &= m \left[ c_{\nu, \text{avg}} (T_2 - T_1) - T_0 (s_2 - s_1) \right] \\ &= (2.13 \text{ kg}) \left[ (0.684 \text{ kJ/kg} \cdot \text{K})(357.9 - 298.2) \text{ K} - (298.2)(0.1253 \text{ kJ/kg} \cdot \text{K}) \right] \\ &= \mathbf{7.74 \text{ kJ}} \end{aligned}$$

since

$$s_2 - s_1 = c_{\nu, \text{avg}} \ln \frac{T_2}{T_1} + R \ln \frac{\mathcal{V}_2}{\mathcal{V}_1} \stackrel{\approx 0}{=} (0.684 \text{ kJ/kg} \cdot \text{K}) \ln \left( \frac{357.9 \text{ K}}{298.2 \text{ K}} \right) = 0.1253 \text{ kJ/kg} \cdot \text{K}$$

**8-43** An insulated cylinder initially contains air at a specified state. A resistance heater inside the cylinder is turned on, and air is heated for 15 min at constant pressure. The exergy destruction during this process is to be determined.

**Assumptions** Air is an ideal gas with variable specific heats.

**Properties** The gas constant of air is  $R = 0.287 \text{ kJ/kg}\cdot\text{K}$  (Table A-1).

**Analysis** The mass of the air and the electrical work done during this process are

$$m = \frac{P_1 V_1}{RT_1} = \frac{(120 \text{ kPa})(0.03 \text{ m}^3)}{(0.287 \text{ kPa}\cdot\text{m}^3/\text{kg}\cdot\text{K})(300 \text{ K})} = 0.0418 \text{ kg}$$

$$W_e = \dot{W}_e \Delta t = (-0.05 \text{ kJ/s})(5 \times 60 \text{ s}) = -15 \text{ kJ}$$

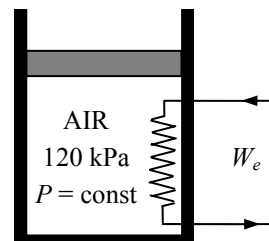

Also,

$$T_1 = 300 \text{ K} \longrightarrow h_1 = 300.19 \text{ kJ/kg} \quad \text{and} \quad s_1^0 = 1.70202 \text{ kJ/kg}\cdot\text{K}$$

The energy balance for this stationary closed system can be expressed as

$$\underbrace{E_{\text{in}} - E_{\text{out}}}_{\substack{\text{Net energy transfer} \\ \text{by heat, work, and mass}}} = \underbrace{\Delta E_{\text{system}}}_{\substack{\text{Change in internal, kinetic,} \\ \text{potential, etc. energies}}}$$

$$W_{e,\text{in}} - W_{b,\text{out}} = \Delta U$$

$$W_{e,\text{in}} = m(h_2 - h_1)$$

since  $\Delta U + W_b = \Delta H$  during a constant pressure quasi-equilibrium process. Thus,

$$h_2 = h_1 + \frac{W_{e,\text{in}}}{m} = 300.19 + \frac{15 \text{ kJ}}{0.0418 \text{ kg}} = 659.04 \text{ kJ/kg} \longrightarrow \begin{matrix} T_2 = 650 \text{ K} \\ s_2^0 = 2.49364 \text{ kJ/kg}\cdot\text{K} \end{matrix}$$

Also,

$$s_2 - s_1 = s_2^0 - s_1^0 - R \ln \left( \frac{P_2}{P_1} \right) \stackrel{\neq 0}{=} s_2^0 - s_1^0 = 2.49364 - 1.70202 = 0.79162 \text{ kJ/kg}\cdot\text{K}$$

The exergy destruction (or irreversibility) associated with this process can be determined from its definition  $X_{\text{destroyed}} = T_0 S_{\text{gen}}$  where the entropy generation is determined from an entropy balance on the cylinder, which is an insulated closed system,

$$\underbrace{S_{\text{in}} - S_{\text{out}}}_{\substack{\text{Net entropy transfer} \\ \text{by heat and mass}}} + \underbrace{S_{\text{gen}}}_{\substack{\text{Entropy} \\ \text{generation}}} = \underbrace{\Delta S_{\text{system}}}_{\substack{\text{Change} \\ \text{in entropy}}}$$

$$S_{\text{gen}} = \Delta S_{\text{system}} = m(s_2 - s_1)$$

Substituting,

$$X_{\text{destroyed}} = T_0 S_{\text{gen}} = m T_0 (s_2 - s_1) = (300 \text{ K})(0.0418 \text{ kg})(0.79162 \text{ kJ/kg}\cdot\text{K}) = \mathbf{9.9 \text{ kJ}}$$

**8-44** A fixed mass of helium undergoes a process from a specified state to another specified state. The increase in the useful energy potential of helium is to be determined.

**Assumptions 1** At specified conditions, helium can be treated as an ideal gas. **2** Helium has constant specific heats at room temperature.

**Properties** The gas constant of helium is  $R = 2.0769 \text{ kJ/kg}\cdot\text{K}$  (Table A-1). The constant volume specific heat of helium is  $c_v = 3.1156 \text{ kJ/kg}\cdot\text{K}$  (Table A-2).

**Analysis** From the ideal-gas entropy change relation,

$$\begin{aligned} s_2 - s_1 &= c_{v,\text{avg}} \ln \frac{T_2}{T_1} + R \ln \frac{v_2}{v_1} \\ &= (3.1156 \text{ kJ/kg}\cdot\text{K}) \ln \frac{353 \text{ K}}{288 \text{ K}} + (2.0769 \text{ kJ/kg}\cdot\text{K}) \ln \frac{0.5 \text{ m}^3/\text{kg}}{3 \text{ m}^3/\text{kg}} = -3.087 \text{ kJ/kg}\cdot\text{K} \end{aligned}$$

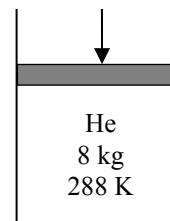

The increase in the useful potential of helium during this process is simply the increase in exergy,

$$\begin{aligned} \Phi_2 - \Phi_1 &= -m[(u_1 - u_2) - T_0(s_1 - s_2) + P_0(v_1 - v_2)] \\ &= -(8 \text{ kg})\{(3.1156 \text{ kJ/kg}\cdot\text{K})(288 - 353) \text{ K} - (298 \text{ K})(3.087 \text{ kJ/kg}\cdot\text{K}) \\ &\quad + (100 \text{ kPa})(3 - 0.5) \text{ m}^3 / \text{kg}[\text{kJ/kPa}\cdot\text{m}^3]\} \\ &= \mathbf{6980 \text{ kJ}} \end{aligned}$$

**8-45** One side of a partitioned insulated rigid tank contains argon gas at a specified temperature and pressure while the other side is evacuated. The partition is removed, and the gas fills the entire tank. The exergy destroyed during this process is to be determined.

**Assumptions** Argon is an ideal gas with constant specific heats, and thus ideal gas relations apply.

**Properties** The gas constant of argon is  $R = 0.208 \text{ kJ/kg}\cdot\text{K}$  (Table A-1).

**Analysis** Taking the entire rigid tank as the system, the energy balance can be expressed as

$$\underbrace{E_{in} - E_{out}}_{\substack{\text{Net energy transfer} \\ \text{by heat, work, and mass}}} = \underbrace{\Delta E_{\text{system}}}_{\substack{\text{Change in internal, kinetic,} \\ \text{potential, etc. energies}}}$$

$$0 = \Delta U = m(u_2 - u_1)$$

$$u_2 = u_1 \rightarrow T_2 = T_1$$

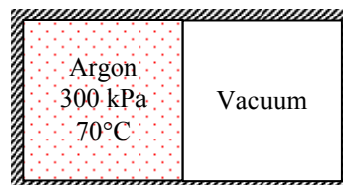

since  $u = u(T)$  for an ideal gas.

The exergy destruction (or irreversibility) associated with this process can be determined from its definition  $X_{\text{destroyed}} = T_0 S_{\text{gen}}$  where the entropy generation is determined from an entropy balance on the entire tank, which is an insulated closed system,

$$\underbrace{S_{in} - S_{out}}_{\substack{\text{Net entropy transfer} \\ \text{by heat and mass}}} + \underbrace{S_{\text{gen}}}_{\substack{\text{Entropy} \\ \text{generation}}} = \underbrace{\Delta S_{\text{system}}}_{\substack{\text{Change} \\ \text{in entropy}}}$$

$$S_{\text{gen}} = \Delta S_{\text{system}} = m(s_2 - s_1)$$

where

$$\Delta S_{\text{system}} = m(s_2 - s_1) = m \left( c_{v,\text{avg}} \ln \frac{T_2}{T_1} + R \ln \frac{v_2}{v_1} \right) = mR \ln \frac{v_2}{v_1}$$

$$= (3 \text{ kg})(0.208 \text{ kJ/kg}\cdot\text{K}) \ln(2) = 0.433 \text{ kJ/K}$$

Substituting,

$$X_{\text{destroyed}} = T_0 S_{\text{gen}} = mT_0 (s_2 - s_1) = (298 \text{ K})(0.433 \text{ kJ/K}) = \mathbf{129 \text{ kJ}}$$

**8-46E** A hot copper block is dropped into water in an insulated tank. The final equilibrium temperature of the tank and the work potential wasted during this process are to be determined.

**Assumptions 1** Both the water and the copper block are incompressible substances with constant specific heats at room temperature. **2** The system is stationary and thus the kinetic and potential energies are negligible. **3** The tank is well-insulated and thus there is no heat transfer.

**Properties** The density and specific heat of water at the anticipated average temperature of 90°F are  $\rho = 62.1 \text{ lbm/ft}^3$  and  $c_p = 1.00 \text{ Btu/lbm}\cdot^\circ\text{F}$ . The specific heat of copper at the anticipated average temperature of 100°F is  $c_p = 0.0925 \text{ Btu/lbm}\cdot^\circ\text{F}$  (Table A-3E).

**Analysis** We take the entire contents of the tank, water + copper block, as the *system*, which is a closed system. The energy balance for this system can be expressed as

$$\underbrace{E_{\text{in}} - E_{\text{out}}}_{\substack{\text{Net energy transfer} \\ \text{by heat, work, and mass}}} = \underbrace{\Delta E_{\text{system}}}_{\substack{\text{Change in internal, kinetic,} \\ \text{potential, etc. energies}}}$$

$$0 = \Delta U$$

or,

$$\Delta U_{\text{Cu}} + \Delta U_{\text{water}} = 0$$

$$[mc(T_2 - T_1)]_{\text{Cu}} + [mc(T_2 - T_1)]_{\text{water}} = 0$$



where

$$m_w = \rho V = (62.1 \text{ lbm/ft}^3)(1.5 \text{ ft}^3) = 93.15 \text{ lbm}$$

Substituting,

$$0 = (70 \text{ lbm})(0.0925 \text{ Btu/lbm}\cdot^\circ\text{F})(T_2 - 250^\circ\text{F}) + (93.15 \text{ lbm})(1.0 \text{ Btu/lbm}\cdot^\circ\text{F})(T_2 - 75^\circ\text{F})$$

$$T_2 = \mathbf{86.4^\circ\text{F}} = 546.4 \text{ R}$$

The wasted work potential is equivalent to the exergy destruction (or irreversibility), and it can be determined from its definition  $X_{\text{destroyed}} = T_0 S_{\text{gen}}$  where the entropy generation is determined from an entropy balance on the system, which is an insulated closed system,

$$\underbrace{S_{\text{in}} - S_{\text{out}}}_{\substack{\text{Net entropy transfer} \\ \text{by heat and mass}}} + \underbrace{S_{\text{gen}}}_{\substack{\text{Entropy} \\ \text{generation}}} = \underbrace{\Delta S_{\text{system}}}_{\substack{\text{Change} \\ \text{in entropy}}}$$

$$S_{\text{gen}} = \Delta S_{\text{system}} = \Delta S_{\text{water}} + \Delta S_{\text{copper}}$$

where

$$\Delta S_{\text{copper}} = mc_{\text{avg}} \ln\left(\frac{T_2}{T_1}\right) = (70 \text{ lbm})(0.092 \text{ Btu/lbm}\cdot\text{R}) \ln\left(\frac{546.4 \text{ R}}{710 \text{ R}}\right) = -1.696 \text{ Btu/R}$$

$$\Delta S_{\text{water}} = mc_{\text{avg}} \ln\left(\frac{T_2}{T_1}\right) = (93.15 \text{ lbm})(1.0 \text{ Btu/lbm}\cdot\text{R}) \ln\left(\frac{546.4 \text{ R}}{535 \text{ R}}\right) = 1.960 \text{ Btu/R}$$

Substituting,

$$X_{\text{destroyed}} = (535 \text{ R})(-1.696 + 1.960) \text{ Btu/R} = \mathbf{140.9 \text{ Btu}}$$

**8-47** A hot iron block is dropped into water in an insulated tank that is stirred by a paddle-wheel. The mass of the iron block and the exergy destroyed during this process are to be determined.  $\surd$

**Assumptions 1** Both the water and the iron block are incompressible substances with constant specific heats at room temperature. **2** The system is stationary and thus the kinetic and potential energies are negligible. **3** The tank is well-insulated and thus there is no heat transfer.

**Properties** The density and specific heat of water at 25°C are  $\rho = 997 \text{ kg/m}^3$  and  $c_p = 4.18 \text{ kJ/kg}\cdot^\circ\text{F}$ . The specific heat of iron at room temperature (the only value available in the tables) is  $c_p = 0.45 \text{ kJ/kg}\cdot^\circ\text{C}$  (Table A-3).

**Analysis** We take the entire contents of the tank, water + iron block, as the system, which is a closed system. The energy balance for this system can be expressed as

$$\underbrace{E_{\text{in}} - E_{\text{out}}}_{\substack{\text{Net energy transfer} \\ \text{by heat, work, and mass}}} = \underbrace{\Delta E_{\text{system}}}_{\substack{\text{Change in internal, kinetic,} \\ \text{potential, etc. energies}}}$$

$$W_{\text{pw,in}} = \Delta U = \Delta U_{\text{iron}} + \Delta U_{\text{water}}$$

$$W_{\text{pw,in}} = [mc(T_2 - T_1)]_{\text{iron}} + [mc(T_2 - T_1)]_{\text{water}}$$

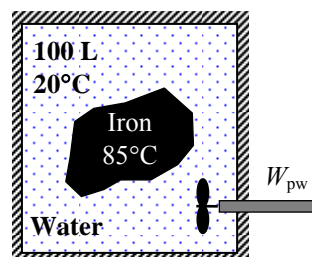

where

$$m_{\text{water}} = \rho V = (997 \text{ kg/m}^3)(0.1 \text{ m}^3) = 99.7 \text{ kg}$$

$$W_{\text{pw}} = \dot{W}_{\text{pw,in}} \Delta t = (0.2 \text{ kJ/s})(20 \times 60 \text{ s}) = 240 \text{ kJ}$$

Substituting,

$$240 \text{ kJ} = m_{\text{iron}} (0.45 \text{ kJ/kg}\cdot^\circ\text{C})(24 - 85)^\circ\text{C} + (99.7 \text{ kg})(4.18 \text{ kJ/kg}\cdot^\circ\text{C})(24 - 20)^\circ\text{C}$$

$$m_{\text{iron}} = \mathbf{52.0 \text{ kg}}$$

(b) The exergy destruction (or irreversibility) can be determined from its definition  $X_{\text{destroyed}} = T_0 S_{\text{gen}}$  where the entropy generation is determined from an entropy balance on the system, which is an insulated closed system,

$$\underbrace{S_{\text{in}} - S_{\text{out}}}_{\substack{\text{Net entropy transfer} \\ \text{by heat and mass}}} + \underbrace{S_{\text{gen}}}_{\substack{\text{Entropy} \\ \text{generation}}} = \underbrace{\Delta S_{\text{system}}}_{\substack{\text{Change} \\ \text{in entropy}}}$$

$$S_{\text{gen}} = \Delta S_{\text{system}} = \Delta S_{\text{iron}} + \Delta S_{\text{water}}$$

where

$$\Delta S_{\text{iron}} = mc_{\text{avg}} \ln\left(\frac{T_2}{T_1}\right) = (52.0 \text{ kg})(0.45 \text{ kJ/kg}\cdot\text{K}) \ln\left(\frac{297 \text{ K}}{358 \text{ K}}\right) = -4.371 \text{ kJ/K}$$

$$\Delta S_{\text{water}} = mc_{\text{avg}} \ln\left(\frac{T_2}{T_1}\right) = (99.7 \text{ kg})(4.18 \text{ kJ/kg}\cdot\text{K}) \ln\left(\frac{297 \text{ K}}{293 \text{ K}}\right) = 5.651 \text{ kJ/K}$$

Substituting,

$$X_{\text{destroyed}} = T_0 S_{\text{gen}} = (293 \text{ K})(-4.371 + 5.651) \text{ kJ/K} = \mathbf{375.0 \text{ kJ}}$$

**8-48** An iron block and a copper block are dropped into a large lake where they cool to lake temperature. The amount of work that could have been produced is to be determined.

**Assumptions 1** The iron and copper blocks and water are incompressible substances with constant specific heats at room temperature. **2** Kinetic and potential energies are negligible.

**Properties** The specific heats of iron and copper at room temperature are  $c_{p, \text{iron}} = 0.45 \text{ kJ/kg}\cdot^\circ\text{C}$  and  $c_{p, \text{copper}} = 0.386 \text{ kJ/kg}\cdot^\circ\text{C}$  (Table A-3).

**Analysis** The thermal-energy capacity of the lake is very large, and thus the temperatures of both the iron and the copper blocks will drop to the lake temperature ( $15^\circ\text{C}$ ) when the thermal equilibrium is established.

We take both the iron and the copper blocks as the system, which is a closed system. The energy balance for this system can be expressed as

$$\underbrace{E_{\text{in}} - E_{\text{out}}}_{\substack{\text{Net energy transfer} \\ \text{by heat, work, and mass}}} = \underbrace{\Delta E_{\text{system}}}_{\substack{\text{Change in internal, kinetic,} \\ \text{potential, etc. energies}}} \\ -Q_{\text{out}} = \Delta U = \Delta U_{\text{iron}} + \Delta U_{\text{copper}}$$

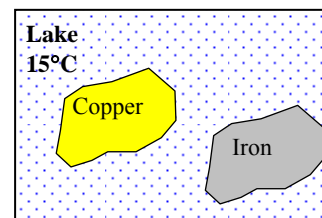

or,

$$Q_{\text{out}} = [mc(T_1 - T_2)]_{\text{iron}} + [mc(T_1 - T_2)]_{\text{copper}}$$

Substituting,

$$Q_{\text{out}} = (50 \text{ kg})(0.45 \text{ kJ/kg}\cdot\text{K})(353 - 288)\text{K} + (20 \text{ kg})(0.386 \text{ kJ/kg}\cdot\text{K})(353 - 288)\text{K} \\ = 1964 \text{ kJ}$$

The work that could have been produced is equal to the wasted work potential. It is equivalent to the exergy destruction (or irreversibility), and it can be determined from its definition  $X_{\text{destroyed}} = T_0 S_{\text{gen}}$ . The entropy generation is determined from an entropy balance on an *extended system* that includes the blocks and the water in their immediate surroundings so that the boundary temperature of the extended system is the temperature of the lake water at all times,

$$\underbrace{S_{\text{in}} - S_{\text{out}}}_{\substack{\text{Net entropy transfer} \\ \text{by heat and mass}}} + \underbrace{S_{\text{gen}}}_{\substack{\text{Entropy} \\ \text{generation}}} = \underbrace{\Delta S_{\text{system}}}_{\substack{\text{Change} \\ \text{in entropy}}} \\ -\frac{Q_{\text{out}}}{T_{\text{b,out}}} + S_{\text{gen}} = \Delta S_{\text{system}} = \Delta S_{\text{iron}} + \Delta S_{\text{copper}} \\ S_{\text{gen}} = \Delta S_{\text{iron}} + \Delta S_{\text{copper}} + \frac{Q_{\text{out}}}{T_{\text{lake}}}$$

where

$$\Delta S_{\text{iron}} = mc_{\text{avg}} \ln\left(\frac{T_2}{T_1}\right) = (50 \text{ kg})(0.45 \text{ kJ/kg}\cdot\text{K}) \ln\left(\frac{288 \text{ K}}{353 \text{ K}}\right) = -4.579 \text{ kJ/K}$$

$$\Delta S_{\text{copper}} = mc_{\text{avg}} \ln\left(\frac{T_2}{T_1}\right) = (20 \text{ kg})(0.386 \text{ kJ/kg}\cdot\text{K}) \ln\left(\frac{288 \text{ K}}{353 \text{ K}}\right) = -1.571 \text{ kJ/K}$$

Substituting,

$$X_{\text{destroyed}} = T_0 S_{\text{gen}} = (293 \text{ K}) \left( -4.579 - 1.571 + \frac{1964 \text{ kJ}}{288 \text{ K}} \right) \text{kJ/K} = \mathbf{196 \text{ kJ}}$$

**8-49E** A rigid tank is initially filled with saturated mixture of R-134a. Heat is transferred to the tank from a source until the pressure inside rises to a specified value. The amount of heat transfer to the tank from the source and the exergy destroyed are to be determined.

**Assumptions 1** The tank is stationary and thus the kinetic and potential energy changes are zero. **2** There is no heat transfer with the environment.

**Properties** From the refrigerant tables (Tables A-11E through A-13E),

$$\begin{aligned}
 \left. \begin{array}{l} P_1 = 40 \text{ psia} \\ x_1 = 0.55 \end{array} \right\} & \begin{array}{l} u_1 = u_f + x_1 u_{fg} = 21.246 + 0.55 \times 77.307 = 63.76 \text{ Btu/lbm} \\ s_1 = s_f + x_1 s_{fg} = 0.04688 + 0.55 \times 0.17580 = 0.1436 \text{ Btu/lbm} \cdot \text{R} \\ v_1 = v_f + x_1 v_{fg} = 0.01232 + 0.55 \times 1.16368 = 0.65234 \text{ ft}^3/\text{lbm} \end{array} \\
 \left. \begin{array}{l} P_2 = 60 \text{ psia} \\ (v_2 = v_1) \end{array} \right\} & \begin{array}{l} x_2 = \frac{v_2 - v_f}{v_{fg}} = \frac{0.65234 - 0.01270}{0.79361 - 0.01270} = 0.8191 \\ s_2 = s_f + x_2 s_{fg} = 0.06029 + 0.8191 \times 0.16098 = 0.1922 \text{ Btu/lbm} \cdot \text{R} \\ u_2 = u_f + x_2 u_{fg} = 27.939 + 0.8191 \times 73.360 = 88.03 \text{ Btu/lbm} \end{array}
 \end{aligned}$$

**Analysis** (a) The mass of the refrigerant is

$$m = \frac{V}{v_1} = \frac{12 \text{ ft}^3}{0.65234 \text{ ft}^3/\text{lbm}} = 18.40 \text{ lbm}$$

We take the tank as the system, which is a closed system. The energy balance for this stationary closed system can be expressed as

$$\underbrace{E_{\text{in}} - E_{\text{out}}}_{\substack{\text{Net energy transfer} \\ \text{by heat, work, and mass}}} = \underbrace{\Delta E_{\text{system}}}_{\substack{\text{Change in internal, kinetic,} \\ \text{potential, etc. energies}}}$$

$$Q_{\text{in}} = \Delta U = m(u_2 - u_1)$$

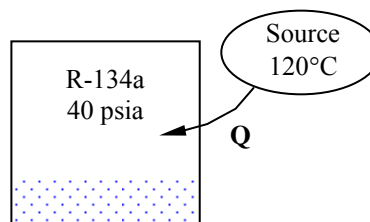

Substituting,

$$Q_{\text{in}} = m(u_2 - u_1) = (18.40 \text{ lbm})(88.03 - 63.76) \text{ Btu/lbm} = \mathbf{446.3 \text{ Btu}}$$

(b) The exergy destruction (or irreversibility) can be determined from its definition  $X_{\text{destroyed}} = T_0 S_{\text{gen}}$ . The entropy generation is determined from an entropy balance on an *extended system* that includes the tank and the region in its immediate surroundings so that the boundary temperature of the extended system where heat transfer occurs is the source temperature,

$$\underbrace{S_{\text{in}} - S_{\text{out}}}_{\substack{\text{Net entropy transfer} \\ \text{by heat and mass}}} + \underbrace{S_{\text{gen}}}_{\substack{\text{Entropy} \\ \text{generation}}} = \underbrace{\Delta S_{\text{system}}}_{\substack{\text{Change} \\ \text{in entropy}}}$$

$$\frac{Q_{\text{in}}}{T_{\text{b,in}}} + S_{\text{gen}} = \Delta S_{\text{system}} = m(s_2 - s_1),$$

$$S_{\text{gen}} = m(s_2 - s_1) - \frac{Q_{\text{in}}}{T_{\text{source}}}$$

Substituting,

$$X_{\text{destroyed}} = T_0 S_{\text{gen}} = (535 \text{ R}) \left[ (18.40 \text{ lbm})(0.1922 - 0.1436) \text{ Btu/lbm} \cdot \text{R} - \frac{446.3 \text{ Btu}}{580 \text{ R}} \right] = \mathbf{66.5 \text{ Btu}}$$



**8-50** Chickens are to be cooled by chilled water in an immersion chiller that is also gaining heat from the surroundings. The rate of heat removal from the chicken and the rate of exergy destruction during this process are to be determined.

**Assumptions 1** Steady operating conditions exist. **2** Thermal properties of chickens and water are constant.

**3** The temperature of the surrounding medium is 25°C.

**Properties** The specific heat of chicken is given to be 3.54 kJ/kg·°C. The specific heat of water at room temperature is 4.18 kJ/kg·°C (Table A-3).

**Analysis** (a) Chickens are dropped into the chiller at a rate of 500 per hour. Therefore, chickens can be considered to flow steadily through the chiller at a mass flow rate of

$$\dot{m}_{\text{chicken}} = (500 \text{ chicken/h})(2.2 \text{ kg/chicken}) = 1100 \text{ kg/h} = 0.3056 \text{ kg/s}$$

Taking the chicken flow stream in the chiller as the system, the energy balance for steadily flowing chickens can be expressed in the rate form as

$$\underbrace{\dot{E}_{\text{in}} - \dot{E}_{\text{out}}}_{\text{Rate of net energy transfer by heat, work, and mass}} = \underbrace{\Delta \dot{E}_{\text{system}}^{\text{no (steady)}}}_{\text{Rate of change in internal, kinetic, potential, etc. energies}} = 0 \rightarrow \dot{E}_{\text{in}} = \dot{E}_{\text{out}}$$

$$\dot{m}h_1 = \dot{Q}_{\text{out}} + \dot{m}h_2 \quad (\text{since } \Delta ke \cong \Delta pe \cong 0)$$

$$\dot{Q}_{\text{out}} = \dot{Q}_{\text{chicken}} = \dot{m}_{\text{chicken}} c_p (T_1 - T_2)$$

Then the rate of heat removal from the chickens as they are cooled from 15°C to 3°C becomes

$$\dot{Q}_{\text{chicken}} = (\dot{m}c_p \Delta T)_{\text{chicken}} = (0.3056 \text{ kg/s})(3.54 \text{ kJ/kg}\cdot\text{°C})(15 - 3)\text{°C} = \mathbf{13.0 \text{ kW}}$$

The chiller gains heat from the surroundings as a rate of 200 kJ/h = 0.0556 kJ/s. Then the total rate of heat gain by the water is

$$\dot{Q}_{\text{water}} = \dot{Q}_{\text{chicken}} + \dot{Q}_{\text{heat gain}} = 13.0 + 0.056 = 13.056 \text{ kW}$$

Noting that the temperature rise of water is not to exceed 2°C as it flows through the chiller, the mass flow rate of water must be at least

$$\dot{m}_{\text{water}} = \frac{\dot{Q}_{\text{water}}}{(c_p \Delta T)_{\text{water}}} = \frac{13.056 \text{ kW}}{(4.18 \text{ kJ/kg}\cdot\text{°C})(2\text{°C})} = 1.56 \text{ kg/s}$$

(b) The exergy destruction can be determined from its definition  $X_{\text{destroyed}} = T_0 S_{\text{gen}}$ . The rate of entropy generation during this chilling process is determined by applying the rate form of the entropy balance on an *extended system* that includes the chiller and the immediate surroundings so that the boundary temperature is the surroundings temperature:

$$\underbrace{\dot{S}_{\text{in}} - \dot{S}_{\text{out}}}_{\text{Rate of net entropy transfer by heat and mass}} + \underbrace{\dot{S}_{\text{gen}}}_{\text{Rate of entropy generation}} = \underbrace{\Delta \dot{S}_{\text{system}}^{\text{no (steady)}}}_{\text{Rate of change of entropy}}$$

$$\dot{m}_1 s_1 + \dot{m}_3 s_3 - \dot{m}_2 s_2 - \dot{m}_3 s_4 + \frac{\dot{Q}_{\text{in}}}{T_{\text{surr}}} + \dot{S}_{\text{gen}} = 0$$

$$\dot{m}_{\text{chicken}} s_1 + \dot{m}_{\text{water}} s_3 - \dot{m}_{\text{chicken}} s_2 - \dot{m}_{\text{water}} s_4 + \frac{\dot{Q}_{\text{in}}}{T_{\text{surr}}} + \dot{S}_{\text{gen}} = 0$$

$$\dot{S}_{\text{gen}} = \dot{m}_{\text{chicken}} (s_2 - s_1) + \dot{m}_{\text{water}} (s_4 - s_3) - \frac{\dot{Q}_{\text{in}}}{T_{\text{surr}}}$$

Noting that both streams are incompressible substances, the rate of entropy generation is determined to be

$$\begin{aligned} \dot{S}_{\text{gen}} &= \dot{m}_{\text{chicken}} c_p \ln \frac{T_2}{T_1} + \dot{m}_{\text{water}} c_p \ln \frac{T_4}{T_3} - \frac{\dot{Q}_{\text{in}}}{T_{\text{surr}}} \\ &= (0.3056 \text{ kg/s})(3.54 \text{ kJ/kg}\cdot\text{K}) \ln \frac{276}{288} + (1.56 \text{ kg/s})(4.18 \text{ kJ/kg}\cdot\text{K}) \ln \frac{275.5}{273.5} - \frac{0.0556 \text{ kW}}{298 \text{ K}} = 0.00128 \text{ kW/K} \end{aligned}$$

$$\text{Finally, } X_{\text{destroyed}} = T_0 \dot{S}_{\text{gen}} = (298 \text{ K})(0.00128 \text{ kW/K}) = \mathbf{0.381 \text{ kW}}$$

**8-51** Carbon steel balls are to be annealed at a rate of 2500/h by heating them first and then allowing them to cool slowly in ambient air at a specified rate. The total rate of heat transfer from the balls to the ambient air and the rate of exergy destruction due to this heat transfer are to be determined.

*Assumptions* 1 The thermal properties of the balls are constant. 2 There are no changes in kinetic and potential energies. 3 The balls are at a uniform temperature at the end of the process.

*Properties* The density and specific heat of the balls are given to be  $\rho = 7833 \text{ kg/m}^3$  and  $c_p = 0.465 \text{ kJ/kg}\cdot^\circ\text{C}$ .

*Analysis* (a) We take a single ball as the system. The energy balance for this closed system can be expressed as

$$\underbrace{E_{\text{in}} - E_{\text{out}}}_{\text{Net energy transfer by heat, work, and mass}} = \underbrace{\Delta E_{\text{system}}}_{\text{Change in internal, kinetic, potential, etc. energies}}$$

$$-Q_{\text{out}} = \Delta U_{\text{ball}} = m(u_2 - u_1)$$

$$Q_{\text{out}} = mc(T_1 - T_2)$$

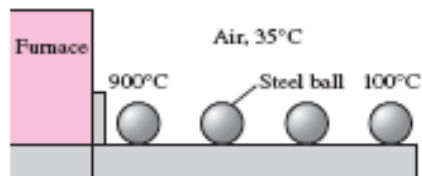

The amount of heat transfer from a single ball is

$$m = \rho V = \rho \frac{\pi D^3}{6} = (7833 \text{ kg/m}^3) \frac{\pi (0.008 \text{ m})^3}{6} = 0.00210 \text{ kg}$$

$$Q_{\text{out}} = mc_p(T_1 - T_2) = (0.0021 \text{ kg})(0.465 \text{ kJ/kg}\cdot^\circ\text{C})(900 - 100)^\circ\text{C} = 781 \text{ J} = 0.781 \text{ kJ (per ball)}$$

Then the total rate of heat transfer from the balls to the ambient air becomes

$$\dot{Q}_{\text{out}} = \dot{n}_{\text{ball}} Q_{\text{out}} = (1200 \text{ balls/h}) \times (0.781 \text{ kJ/ball}) = 936 \text{ kJ/h} = \mathbf{260 \text{ W}}$$

(b) The exergy destruction (or irreversibility) can be determined from its definition  $X_{\text{destroyed}} = T_0 S_{\text{gen}}$ . The entropy generated during this process can be determined by applying an entropy balance on an *extended system* that includes the ball and its immediate surroundings so that the boundary temperature of the extended system is at  $35^\circ\text{C}$  at all times:

$$\underbrace{S_{\text{in}} - S_{\text{out}}}_{\text{Net entropy transfer by heat and mass}} + \underbrace{S_{\text{gen}}}_{\text{Entropy generation}} = \underbrace{\Delta S_{\text{system}}}_{\text{Change in entropy}}$$

$$-\frac{Q_{\text{out}}}{T_b} + S_{\text{gen}} = \Delta S_{\text{system}} \rightarrow S_{\text{gen}} = \frac{Q_{\text{out}}}{T_b} + \Delta S_{\text{system}}$$

where

$$\Delta S_{\text{system}} = m(s_2 - s_1) = mc_{\text{avg}} \ln \frac{T_2}{T_1} = (0.00210 \text{ kg})(0.465 \text{ kJ/kg}\cdot\text{K}) \ln \frac{100 + 273}{900 + 273} = -0.00112 \text{ kJ/K}$$

Substituting,

$$S_{\text{gen}} = \frac{Q_{\text{out}}}{T_b} + \Delta S_{\text{system}} = \frac{0.781 \text{ kJ}}{308 \text{ K}} - 0.00112 \text{ kJ/K} = 0.00142 \text{ kJ/K (per ball)}$$

Then the rate of entropy generation becomes

$$\dot{S}_{\text{gen}} = S_{\text{gen}} \dot{n}_{\text{ball}} = (0.00142 \text{ kJ/K}\cdot\text{ball})(1200 \text{ balls/h}) = 1.704 \text{ kJ/h}\cdot\text{K} = 0.000473 \text{ kW/K}$$

Finally,

$$\dot{X}_{\text{destroyed}} = T_0 \dot{S}_{\text{gen}} = (308 \text{ K})(0.000473 \text{ kW/K}) = 0.146 \text{ kW} = \mathbf{146 \text{ W}}$$

**8-52** A tank containing hot water is placed in a larger tank. The amount of heat lost to the surroundings and the exergy destruction during the process are to be determined.

**Assumptions** **1** Kinetic and potential energy changes are negligible. **2** Air is an ideal gas with constant specific heats. **3** The larger tank is well-sealed.

**Properties** The properties of air at room temperature are  $R = 0.287 \text{ kPa}\cdot\text{m}^3/\text{kg}\cdot\text{K}$ ,  $c_p = 1.005 \text{ kJ/kg}\cdot\text{K}$ ,  $c_v = 0.718 \text{ kJ/kg}\cdot\text{K}$  (Table A-2). The properties of water at room temperature are  $\rho = 1000 \text{ kg/m}^3$ ,  $c_w = 4.18 \text{ kJ/kg}\cdot\text{K}$ .

**Analysis** (a) The final volume of the air in the tank is

$$V_{a2} = V_{a1} - V_w = 0.04 - 0.015 = 0.025 \text{ m}^3$$

The mass of the air in the room is

$$m_a = \frac{P_1 V_{a1}}{RT_{a1}} = \frac{(100 \text{ kPa})(0.04 \text{ m}^3)}{(0.287 \text{ kPa}\cdot\text{m}^3/\text{kg}\cdot\text{K})(22 + 273 \text{ K})} = 0.04724 \text{ kg}$$

The pressure of air at the final state is

$$P_{a2} = \frac{m_a RT_{a2}}{V_{a2}} = \frac{(0.04724 \text{ kg})(0.287 \text{ kPa}\cdot\text{m}^3/\text{kg}\cdot\text{K})(44 + 273 \text{ K})}{0.025 \text{ m}^3} = 171.9 \text{ kPa}$$

The mass of water is

$$m_w = \rho_w V_w = (1000 \text{ kg/m}^3)(0.015 \text{ m}^3) = 14.53 \text{ kg}$$

An energy balance on the system consisting of water and air is used to determine heat lost to the surroundings

$$\begin{aligned} Q_{\text{out}} &= -[m_w c_w (T_2 - T_{w1}) + m_a c_v (T_2 - T_{a1})] \\ &= -(14.53 \text{ kg})(4.18 \text{ kJ/kg}\cdot\text{K})(44 - 85) - (0.04724 \text{ kg})(0.718 \text{ kJ/kg}\cdot\text{K})(44 - 22) \\ &= \mathbf{2489 \text{ kJ}} \end{aligned}$$

(b) An exergy balance written on the (system + immediate surroundings) can be used to determine exergy destruction. But we first determine entropy and internal energy changes

$$\Delta S_w = m_w c_w \ln \frac{T_{w1}}{T_2} = (14.53 \text{ kg})(4.18 \text{ kJ/kg}\cdot\text{K}) \ln \frac{(85 + 273) \text{ K}}{(44 + 273) \text{ K}} = 7.3873 \text{ kJ/K}$$

$$\begin{aligned} \Delta S_a &= m_a \left[ c_p \ln \frac{T_{a1}}{T_2} - R \ln \frac{P_{a1}}{P_2} \right] \\ &= (0.04724 \text{ kg}) \left[ (1.005 \text{ kJ/kg}\cdot\text{K}) \ln \frac{(22 + 273) \text{ K}}{(44 + 273) \text{ K}} - (0.287 \text{ kJ/kg}\cdot\text{K}) \ln \frac{100 \text{ kPa}}{171.9 \text{ kPa}} \right] \\ &= 0.003931 \text{ kJ/K} \end{aligned}$$

$$\Delta U_w = m_w c_w (T_{1w} - T_2) = (14.53 \text{ kg})(4.18 \text{ kJ/kg}\cdot\text{K})(85 - 44) \text{ K} = 2490 \text{ kJ}$$

$$\Delta U_a = m_a c_v (T_{1a} - T_2) = (0.04724 \text{ kg})(0.718 \text{ kJ/kg}\cdot\text{K})(22 - 44) \text{ K} = -0.7462 \text{ kJ}$$

$$\begin{aligned} X_{\text{dest}} &= \Delta X_w + \Delta X_a \\ &= \Delta U_w - T_0 \Delta S_w + \Delta U_a - T_0 \Delta S_a \\ &= 2490 \text{ kJ} - (295 \text{ K})(7.3873 \text{ kJ/K}) + (-0.7462 \text{ kJ}) - (295 \text{ K})(0.003931 \text{ kJ/K}) \\ &= \mathbf{308.8 \text{ kJ}} \end{aligned}$$

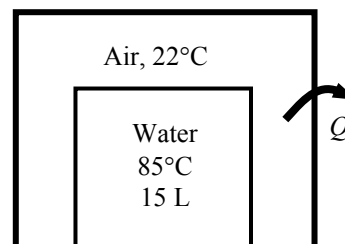

**8-53** Heat is transferred to a piston-cylinder device with a set of stops. The work done, the heat transfer, the exergy destroyed, and the second-law efficiency are to be determined.

**Assumptions 1** The device is stationary and kinetic and potential energy changes are zero. **2** There is no friction between the piston and the cylinder.

**Analysis (a)** The properties of the refrigerant at the initial and final states are (Tables A-11 through A-13)

$$\begin{aligned} P_1 = 120 \text{ kPa} & \left\{ \begin{array}{l} v_1 = 0.16544 \text{ m}^3/\text{kg} \\ u_1 = 248.22 \text{ kJ/kg} \\ s_1 = 1.0624 \text{ kJ/kg}\cdot\text{K} \end{array} \right. \\ T_1 = 20^\circ\text{C} & \\ \\ P_2 = 180 \text{ kPa} & \left\{ \begin{array}{l} v_2 = 0.17563 \text{ m}^3/\text{kg} \\ u_2 = 331.96 \text{ kJ/kg} \\ s_2 = 1.3118 \text{ kJ/kg}\cdot\text{K} \end{array} \right. \\ T_2 = 120^\circ\text{C} & \end{aligned}$$

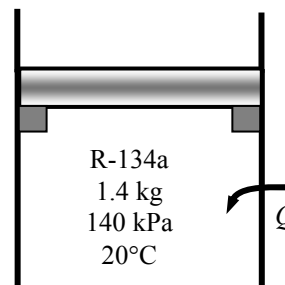

The boundary work is determined to be

$$W_{b,\text{out}} = mP_2(v_2 - v_1) = (1.4 \text{ kg})(180 \text{ kPa})(0.17563 - 0.16544) \text{ m}^3/\text{kg} = \mathbf{2.57 \text{ kJ}}$$

(b) The heat transfer can be determined from an energy balance on the system

$$Q_{\text{in}} = m(u_2 - u_1) + W_{b,\text{out}} = (1.4 \text{ kg})(331.96 - 248.22) \text{ kJ/kg} + 2.57 \text{ kJ} = \mathbf{119.8 \text{ kJ}}$$

(c) The exergy difference between the inlet and exit states is

$$\begin{aligned} \Delta X &= m[u_2 - u_1 - T_0(s_2 - s_1) + P_0(v_2 - v_1)] \\ &= (1.4 \text{ kg}) \left[ (331.96 - 248.22) \text{ kJ/kg} - (298 \text{ K})(1.3118 - 1.0624) \text{ kJ/kg}\cdot\text{K} + (100 \text{ kPa})(0.17563 - 0.16544) \text{ m}^3/\text{kg} \right] \\ &= 14.61 \text{ kJ} \end{aligned}$$

The useful work output for the process is

$$W_{u,\text{out}} = W_{b,\text{out}} - mP_0(v_2 - v_1) = 2.57 \text{ kJ} - (1.4 \text{ kg})(100 \text{ kPa})(0.17563 - 0.16544) \text{ m}^3/\text{kg} = 1.14 \text{ kJ}$$

The exergy destroyed is the difference between the exergy difference and the useful work output

$$X_{\text{dest}} = \Delta X - W_{u,\text{out}} = 14.61 - 1.14 = \mathbf{13.47 \text{ kJ}}$$

(d) The second-law efficiency for this process is

$$\eta_{\text{II}} = \frac{W_{u,\text{out}}}{\Delta X} = \frac{1.14 \text{ kJ}}{14.61 \text{ kJ}} = \mathbf{0.078}$$

## Second-Law Analysis of Control Volumes

**8-54** Steam is throttled from a specified state to a specified pressure. The wasted work potential during this throttling process is to be determined.

**Assumptions 1** This is a steady-flow process since there is no change with time. **2** Kinetic and potential energy changes are negligible. **3** The temperature of the surroundings is given to be 25°C. **4** Heat transfer is negligible.

**Properties** The properties of steam before and after the throttling process are (Tables A-4 through A-6)

$$\left. \begin{aligned} P_1 &= 8 \text{ MPa} \\ T_1 &= 450^\circ\text{C} \end{aligned} \right\} \begin{aligned} h_1 &= 3273.3 \text{ kJ/kg} \\ s_1 &= 6.5579 \text{ kJ/kg} \cdot \text{K} \end{aligned}$$

$$\left. \begin{aligned} P_2 &= 6 \text{ MPa} \\ h_2 &= h_1 \end{aligned} \right\} s_2 = 6.6806 \text{ kJ/kg} \cdot \text{K}$$

**Analysis** The wasted work potential is equivalent to the exergy destruction (or irreversibility). It can be determined from an exergy balance or directly from its definition  $X_{\text{destroyed}} = T_0 S_{\text{gen}}$  where the entropy generation is determined from an entropy balance on the device, which is an adiabatic steady-flow system,

$$\underbrace{\dot{S}_{\text{in}} - \dot{S}_{\text{out}}}_{\text{Rate of net entropy transfer by heat and mass}} + \underbrace{\dot{S}_{\text{gen}}}_{\text{Rate of entropy generation}} = \underbrace{\Delta \dot{S}_{\text{system}}}_{\text{Rate of change of entropy}} \stackrel{\neq 0}{=} 0$$

$$\dot{m}s_1 - \dot{m}s_2 + \dot{S}_{\text{gen}} = 0 \rightarrow \dot{S}_{\text{gen}} = \dot{m}(s_2 - s_1) \quad \text{or} \quad s_{\text{gen}} = s_2 - s_1$$

Substituting,

$$x_{\text{destroyed}} = T_0 s_{\text{gen}} = T_0 (s_2 - s_1) = (298 \text{ K})(6.6806 - 6.5579) \text{ kJ/kg} \cdot \text{K} = \mathbf{36.6 \text{ kJ/kg}}$$

**Discussion** Note that 36.6 kJ/kg of work potential is wasted during this throttling process.

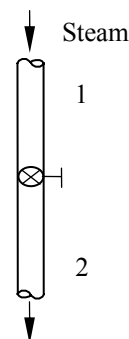

**8-55** [Also solved by EES on enclosed CD] Air is compressed steadily by an 8-kW compressor from a specified state to another specified state. The increase in the exergy of air and the rate of exergy destruction are to be determined.

**Assumptions** 1 Air is an ideal gas with variable specific heats. 2 Kinetic and potential energy changes are negligible.

**Properties** The gas constant of air is  $R = 0.287 \text{ kJ/kg}\cdot\text{K}$  (Table A-1).  
From the air table (Table A-17)

$$T_1 = 290 \text{ K} \longrightarrow \begin{aligned} h_1 &= 290.16 \text{ kJ/kg} \\ s_1^\circ &= 1.66802 \text{ kJ/kg}\cdot\text{K} \end{aligned}$$

$$T_2 = 440 \text{ K} \longrightarrow \begin{aligned} h_2 &= 441.61 \text{ kJ/kg} \\ s_2^\circ &= 2.0887 \text{ kJ/kg}\cdot\text{K} \end{aligned}$$

**Analysis** The increase in exergy is the difference between the exit and inlet flow exergies,

$$\begin{aligned} \text{Increase in exergy} &= \psi_2 - \psi_1 \\ &= [(h_2 - h_1) + \Delta ke^{\text{ex}} + \Delta pe^{\text{ex}} - T_0(s_2 - s_1)] \\ &= (h_2 - h_1) - T_0(s_2 - s_1) \end{aligned}$$

where

$$\begin{aligned} s_2 - s_1 &= (s_2^\circ - s_1^\circ) - R \ln \frac{P_2}{P_1} \\ &= (2.0887 - 1.66802) \text{ kJ/kg}\cdot\text{K} - (0.287 \text{ kJ/kg}\cdot\text{K}) \ln \frac{600 \text{ kPa}}{100 \text{ kPa}} \\ &= -0.09356 \text{ kJ/kg}\cdot\text{K} \end{aligned}$$

Substituting,

$$\begin{aligned} \text{Increase in exergy} &= \psi_2 - \psi_1 \\ &= [(441.61 - 290.16) \text{ kJ/kg} - (290 \text{ K})(-0.09356 \text{ kJ/kg}\cdot\text{K})] \\ &= \mathbf{178.6 \text{ kJ/kg}} \end{aligned}$$

Then the reversible power input becomes

$$\dot{W}_{\text{rev,in}} = \dot{m}(\psi_2 - \psi_1) = (2.1 / 60 \text{ kg/s})(178.6 \text{ kJ/kg}) = \mathbf{6.25 \text{ kW}}$$

(b) The rate of exergy destruction (or irreversibility) is determined from its definition,

$$\dot{X}_{\text{destroyed}} = \dot{W}_{\text{in}} - \dot{W}_{\text{rev,in}} = 8 - 6.25 = \mathbf{1.75 \text{ kW}}$$

**Discussion** Note that 1.75 kW of power input is wasted during this compression process.

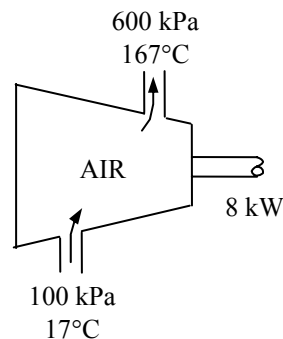

**8-56 EES** Problem 8-55 is reconsidered. The problem is to be solved and the actual heat transfer, its direction, the minimum power input, and the compressor second-law efficiency are to be determined.

**Analysis** The problem is solved using EES, and the solution is given below.

```

Function Direction$(Q)
If Q<0 then Direction$='out' else Direction$='in'
end
Function Violation$(eta)
If eta>1 then Violation$='You have violated the 2nd Law!!!!' else Violation$=""
end

{"Input Data from the Diagram Window"}
T_1=17 [C]
P_1=100 [kPa]
W_dot_c = 8 [kW]
P_2=600 [kPa]
S_dot_gen=0
Q_dot_net=0}
{"Special cases"}
T_2=167 [C]
m_dot=2.1 [kg/min]}
T_o=T_1
P_o=P_1
m_dot_in=m_dot*Convert(kg/min, kg/s)
"Steady-flow conservation of mass"
m_dot_in = m_dot_out
"Conservation of energy for steady-flow is:"
E_dot_in - E_dot_out = DELTAE_dot
DELTAE_dot = 0
E_dot_in=Q_dot_net + m_dot_in*h_1 +W_dot_c
"If Q_dot_net < 0, heat is transferred from the compressor"
E_dot_out= m_dot_out*h_2
h_1 =enthalpy(air,T=T_1)
h_2 = enthalpy(air, T=T_2)
W_dot_net=-W_dot_c
W_dot_rev=-m_dot_in*(h_2 - h_1 -(T_1+273.15)*(s_2-s_1))
"Irreversibility, entropy generated, second law efficiency, and exergy destroyed:"
s_1=entropy(air, T=T_1,P=P_1)
s_2=entropy(air,T=T_2,P=P_2)
s_2s=entropy(air,T=T_2s,P=P_2)
s_2s=s_1"This yields the isentropic T_2s for an isentropic process bewteen T_1, P_1 and
P_2"i_dot=(T_o+273.15)*S_dot_gen"Irreversibility for the Process, KW"
S_dot_gen=(-Q_dot_net/(T_o+273.15) +m_dot_in*(s_2-s_1)) "Entropy generated, kW"
Eta_II=W_dot_rev/W_dot_net"Definition of compressor second law efficiency, Eq. 7_6"
h_o=enthalpy(air,T=T_o)
s_o=entropy(air,T=T_o,P=P_o)
Psi_in=h_1-h_o-(T_o+273.15)*(s_1-s_o) "availability function at state 1"
Psi_out=h_2-h_o-(T_o+273.15)*(s_2-s_o) "availability function at state 2"
X_dot_in=Psi_in*m_dot_in
X_dot_out=Psi_out*m_dot_out
DELTAX_dot=X_dot_in-X_dot_out
"General Exergy balance for a steady-flow system, Eq. 7-47"
(1-(T_o+273.15)/(T_o+273.15))*Q_dot_net-W_dot_net+m_dot_in*Psi_in - m_dot_out*Psi_out
=X_dot_dest
"For the Diagram Window"

```

Text\$=Direction\$(Q\_dot\_net)

Text2\$=Violation\$(Eta\_II)

$\eta_{II}$	I [kW]	$\dot{X}_{dest}$ [kW]	$T_{2s}$ [C]	$T_2$ [C]	$Q_{net}$ [kW]
0.7815	1.748	1.748	209.308	167	-2.7
0.8361	1.311	1.311	209.308	200.6	-1.501
0.8908	0.874	0.874	209.308	230.5	-0.4252
0.9454	0.437	0.437	209.308	258.1	0.5698
1	1.425E-13	5.407E-15	209.308	283.9	1.506

How can entropy decrease?

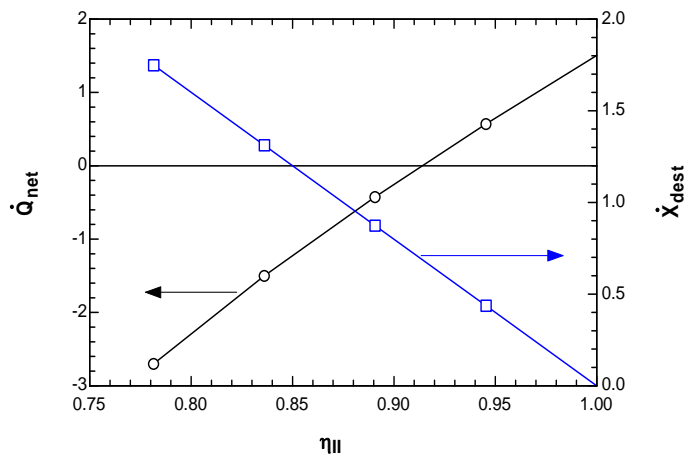
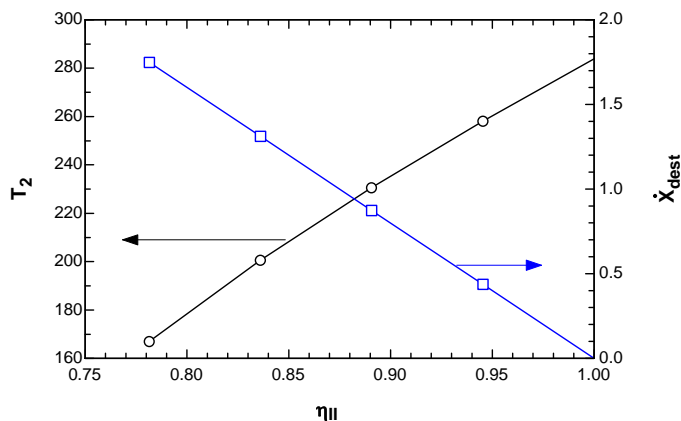
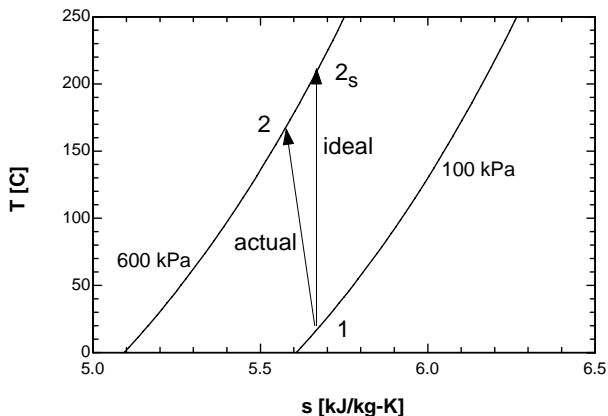



**8-57** Air expands in an adiabatic turbine from a specified state to another specified state. The actual and maximum work outputs are to be determined.

**Assumptions 1** This is a steady-flow process since there is no change with time. **2** The device is adiabatic and thus heat transfer is negligible. **3** Air is an ideal gas with constant specific heats. **4** Potential energy changes are negligible.

**Properties** At the average temperature of  $(425 + 325)/2 = 375$  K, the constant pressure specific heat of air is  $c_p = 1.011$  kJ/kg·K (Table A-2b). The gas constant of air is  $R = 0.287$  kJ/kg·K (Table A-1).

**Analysis** There is only one inlet and one exit, and thus  $\dot{m}_1 = \dot{m}_2 = \dot{m}$ . We take the turbine as the system, which is a control volume since mass crosses the boundary. The energy balance for this steady-flow system can be expressed in the rate form as

$$\underbrace{\dot{E}_{\text{in}} - \dot{E}_{\text{out}}}_{\text{Rate of net energy transfer by heat, work, and mass}} = \underbrace{\dot{\Delta E}_{\text{system}}^{\text{no (steady)}}}_{\text{Rate of change in internal, kinetic, potential, etc. energies}} = 0$$

$$\dot{E}_{\text{in}} = \dot{E}_{\text{out}}$$

$$\dot{m}(h_1 + V_1^2/2) = \dot{W}_{\text{out}} + \dot{m}(h_2 + V_2^2/2)$$

$$\dot{W}_{\text{out}} = \dot{m} \left[ h_1 - h_2 + \frac{V_1^2 - V_2^2}{2} \right]$$

$$w_{\text{out}} = c_p(T_1 - T_2) + \frac{V_1^2 - V_2^2}{2}$$

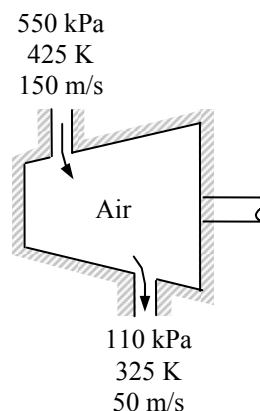

Substituting,

$$\begin{aligned} w_{\text{out}} &= c_p(T_1 - T_2) + \frac{V_1^2 - V_2^2}{2} \\ &= (1.011 \text{ kJ/kg} \cdot \text{K})(425 - 325) \text{ K} + \frac{(150 \text{ m/s})^2 - (50 \text{ m/s})^2}{2} \left( \frac{1 \text{ kJ/kg}}{1000 \text{ m}^2/\text{s}^2} \right) \\ &= \mathbf{111.1 \text{ kJ/kg}} \end{aligned}$$

The entropy change of air is

$$\begin{aligned} s_2 - s_1 &= c_p \ln \frac{T_2}{T_1} - R \ln \frac{P_2}{P_1} \\ &= (1.011 \text{ kJ/kg} \cdot \text{K}) \ln \frac{325 \text{ K}}{425 \text{ K}} - (0.287 \text{ kJ/kg} \cdot \text{K}) \ln \frac{110 \text{ kPa}}{550 \text{ kPa}} \\ &= 0.1907 \text{ kJ/kg} \cdot \text{K} \end{aligned}$$

The maximum (reversible) work is the exergy difference between the inlet and exit states

$$\begin{aligned} w_{\text{rev,out}} &= c_p(T_1 - T_2) + \frac{V_1^2 - V_2^2}{2} - T_0(s_1 - s_2) \\ &= w_{\text{out}} - T_0(s_1 - s_2) \\ &= 111.1 \text{ kJ/kg} - (298 \text{ K})(-0.1907 \text{ kJ/kg} \cdot \text{K}) \\ &= \mathbf{167.9 \text{ kJ/kg}} \end{aligned}$$

Irreversibilities occurring inside the turbine cause the actual work production to be less than the reversible (maximum) work. The difference between the reversible and actual works is the irreversibility.

**8-58E** Air is compressed in a compressor from a specified state to another specified state. The minimum work input is to be determined.

**Assumptions 1** This is a steady-flow process since there is no change with time. **2** Kinetic and potential energy changes are negligible. **3** Air is an ideal gas with constant specific heats. **4** The inlet state of air is taken as the dead state.

**Properties** The properties of air at room temperature are  $c_p = 0.240$  Btu/lbm·R and  $R = 0.06855$  Btu/lbm·R (Table A-2Ea).

**Analysis** The entropy change of air is

$$\begin{aligned} s_2 - s_1 &= c_p \ln \frac{T_2}{T_1} - R \ln \frac{P_2}{P_1} \\ &= (0.240 \text{ Btu/lbm} \cdot \text{R}) \ln \frac{660 \text{ R}}{537 \text{ R}} - (0.06855 \text{ Btu/lbm} \cdot \text{R}) \ln \frac{140 \text{ psia}}{14.7 \text{ psia}} \\ &= -0.1050 \text{ Btu/lbm} \cdot \text{R} \end{aligned}$$

The minimum (reversible) work is the exergy difference between the inlet and exit states

$$\begin{aligned} w_{\text{rev,in}} &= c_p(T_2 - T_1) - T_0(s_2 - s_1) \\ &= (0.240 \text{ Btu/lbm} \cdot \text{R})(200 - 77)\text{R} - (537 \text{ R})(-0.1050 \text{ Btu/lbm} \cdot \text{R}) \\ &= \mathbf{85.9 \text{ Btu/lbm}} \end{aligned}$$

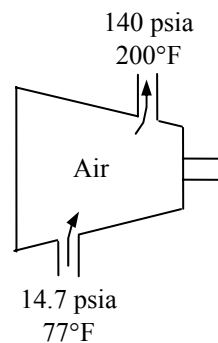

There is only one inlet and one exit, and thus  $\dot{m}_1 = \dot{m}_2 = \dot{m}$ . We take the compressor as the system, which is a control volume since mass crosses the boundary. The energy balance for this steady-flow system can be expressed in the rate form as

$$\underbrace{\dot{E}_{\text{in}} - \dot{E}_{\text{out}}}_{\text{Rate of net energy transfer by heat, work, and mass}} = \underbrace{\dot{\Delta E}_{\text{system}}^{\text{no (steady)}}}_{\text{Rate of change in internal, kinetic, potential, etc. energies}} = 0$$

$$\dot{E}_{\text{in}} = \dot{E}_{\text{out}}$$

$$h_1 + w_{\text{in}} = h_2 + q_{\text{out}}$$

$$w_{\text{in}} = h_2 - h_1 + q_{\text{out}}$$

Inspection of this result reveals that for the same inlet and exit states, any rejection of heat will increase the actual work that must be supplied to the compressor.

The reversible (or minimum) power input is determined from the exergy balance applied on the compressor, and setting the exergy destruction term equal to zero,

$$\underbrace{\dot{X}_{\text{in}} - \dot{X}_{\text{out}}}_{\text{Rate of net exergy transfer by heat, work, and mass}} - \underbrace{\dot{X}_{\text{destroyed}}^{\text{no (reversible)}}}_{\text{Rate of exergy destruction}} = \underbrace{\dot{\Delta X}_{\text{system}}^{\text{no (steady)}}}_{\text{Rate of change of exergy}} = 0$$

$$\dot{X}_{\text{in}} = \dot{X}_{\text{out}}$$

$$\dot{m}\psi_1 + \dot{W}_{\text{rev,in}} = \dot{m}\psi_2 + \dot{X}_{\text{heat,out}}$$

$$\dot{W}_{\text{rev,in}} = \dot{m}(\psi_2 - \psi_1) + \dot{Q}_{\text{out}} \left( 1 - \frac{T_0}{T} \right)$$

$$\dot{W}_{\text{rev,in}} = \dot{m}[(h_2 - h_1) - T_0(s_2 - s_1)] + \dot{Q}_{\text{out}} \left( 1 - \frac{T_0}{T} \right)$$

$$w_{\text{rev,in}} = c_p(T_2 - T_1) - T_0(s_2 - s_1) + q_{\text{out}} \left( 1 - \frac{T_0}{T} \right)$$

Inspection of this result reveals that for the same inlet and exit states, any rejection of heat will increase the reversible (minimum) work that must be supplied to the compressor.

**8-59** Refrigerant-134a is compressed by an adiabatic compressor from a specified state to another specified state. The minimum power required is to be determined.

**Assumptions 1** This is a steady-flow process since there is no change with time. **2** Kinetic and potential energy changes are negligible. **3** The device is adiabatic and thus heat transfer is negligible.

**Properties** From the refrigerant tables (Tables A-11 through A-13)

$$\left. \begin{array}{l} P_1 = 160 \text{ kPa} \\ x_1 = 1 \text{ (sat. vap.)} \end{array} \right\} \begin{array}{l} h_1 = 241.11 \text{ kJ/kg} \\ s_1 = 0.94190 \text{ kJ/kg} \cdot \text{K} \end{array}$$

$$\left. \begin{array}{l} P_2 = 800 \text{ kPa} \\ T_2 = 50^\circ\text{C} \end{array} \right\} \begin{array}{l} h_2 = 286.69 \text{ kJ/kg} \\ s_2 = 0.9802 \text{ kJ/kg} \cdot \text{K} \end{array}$$

The minimum (reversible) power is

$$\begin{aligned} \dot{W}_{\text{rev,in}} &= \dot{m}[h_2 - h_1 - T_0(s_2 - s_1)] \\ &= (0.1 \text{ kg/s})[(286.69 - 241.11) \text{ kJ/kg} - (298 \text{ K})(0.9802 - 0.94190) \text{ kJ/kg} \cdot \text{K}] \\ &= \mathbf{3.42 \text{ kW}} \end{aligned}$$

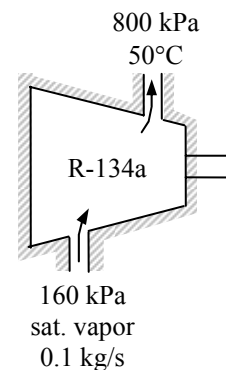

**8-60** Steam is decelerated in a diffuser. The second law efficiency of the diffuser is to be determined.

**Assumptions 1** The diffuser operates steadily. **2** The changes in potential energies are negligible.

**Properties** The properties of steam at the inlet and the exit of the diffuser are (Tables A-4 through A-6)

$$\left. \begin{array}{l} P_1 = 500 \text{ kPa} \\ T_1 = 200^\circ\text{C} \end{array} \right\} \begin{array}{l} h_1 = 2855.8 \text{ kJ/kg} \\ s_1 = 7.0610 \text{ kJ/kg}\cdot\text{K} \end{array}$$

$$\left. \begin{array}{l} P_2 = 200 \text{ kPa} \\ x_2 = 1 \text{ (sat. vapor)} \end{array} \right\} \begin{array}{l} h_2 = 2706.3 \text{ kJ/kg} \\ s_2 = 7.1270 \text{ kJ/kg}\cdot\text{K} \end{array}$$

**Analysis** We take the diffuser to be the system, which is a control volume. The energy balance for this steady-flow system can be expressed in the rate form as

$$\underbrace{\dot{E}_{\text{in}} - \dot{E}_{\text{out}}}_{\text{Rate of net energy transfer by heat, work, and mass}} = \underbrace{\Delta\dot{E}_{\text{system}}}_{\text{Rate of change in internal, kinetic, potential, etc. energies}} \overset{\neq 0 \text{ (steady)}}{=} 0$$

$$\dot{E}_{\text{in}} = \dot{E}_{\text{out}}$$

$$\dot{m}(h_1 + V_1^2/2) = \dot{m}(h_2 + V_2^2/2)$$

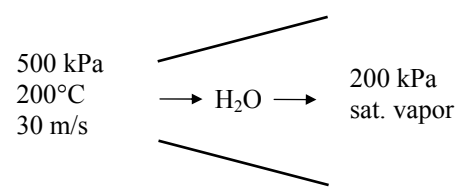
$$\frac{V_2^2 - V_1^2}{2} = h_1 - h_2 = \Delta\text{ke}_{\text{actual}}$$

Substituting,

$$\Delta\text{ke}_{\text{actual}} = h_1 - h_2 = 2855.8 - 2706.3 = 149.5 \text{ kJ/kg}$$

An exergy balance on the diffuser gives

$$\underbrace{\dot{X}_{\text{in}} - \dot{X}_{\text{out}}}_{\text{Rate of net exergy transfer by heat, work, and mass}} - \underbrace{\dot{X}_{\text{destroyed}}}_{\text{Rate of exergy destruction}} \overset{\neq 0 \text{ (reversible)}}{=} \underbrace{\Delta\dot{X}_{\text{system}}}_{\text{Rate of change of exergy}} \overset{\neq 0 \text{ (steady)}}{=} 0$$

$$\dot{X}_{\text{in}} = \dot{X}_{\text{out}}$$

$$\dot{m}\psi_1 = \dot{m}\psi_2$$

$$h_1 - h_0 + \frac{V_1^2}{2} - T_0(s_1 - s_0) = h_2 - h_0 + \frac{V_2^2}{2} - T_0(s_2 - s_0)$$

$$\frac{V_2^2 - V_1^2}{2} = h_1 - h_2 - T_0(s_1 - s_2)$$

$$\Delta\text{ke}_{\text{rev}} = h_1 - h_2 - T_0(s_1 - s_2)$$

Substituting,

$$\begin{aligned} \Delta\text{ke}_{\text{rev}} &= h_1 - h_2 - T_0(s_1 - s_2) \\ &= (2855.8 - 2706.3) \text{ kJ/kg} - (298 \text{ K})(7.0610 - 7.1270) \text{ kJ/kg}\cdot\text{K} \\ &= 169.2 \text{ kJ/kg} \end{aligned}$$

The second law efficiency is then

$$\eta_{\text{II}} = \frac{\Delta\text{ke}_{\text{actual}}}{\Delta\text{ke}_{\text{rev}}} = \frac{149.5 \text{ kJ/kg}}{169.2 \text{ kJ/kg}} = \mathbf{0.884}$$

**8-61** Air is accelerated in a nozzle while losing some heat to the surroundings. The exit temperature of air and the exergy destroyed during the process are to be determined.

**Assumptions 1** Air is an ideal gas with variable specific heats. **2** The nozzle operates steadily.

**Properties** The gas constant of air is  $R = 0.287 \text{ kJ/kg}\cdot\text{K}$  (Table A-1). The properties of air at the nozzle inlet are (Table A-17)

$$T_1 = 360 \text{ K} \longrightarrow h_1 = 360.58 \text{ kJ/kg}$$

$$s_1^0 = 1.88543 \text{ kJ/kg}\cdot\text{K}$$

**Analysis** (a) We take the nozzle as the system, which is a control volume. The energy balance for this steady-flow system can be expressed in the rate form as

$$\underbrace{\dot{E}_{\text{in}} - \dot{E}_{\text{out}}}_{\text{Rate of net energy transfer by heat, work, and mass}} = \underbrace{\Delta \dot{E}_{\text{system}}^{\neq 0}}_{\text{Rate of change in internal, kinetic, potential, etc. energies}} = 0$$

$$\dot{E}_{\text{in}} = \dot{E}_{\text{out}}$$

$$\dot{m}(h_1 + V_1^2/2) = \dot{m}(h_2 + V_2^2/2) + \dot{Q}_{\text{out}}$$

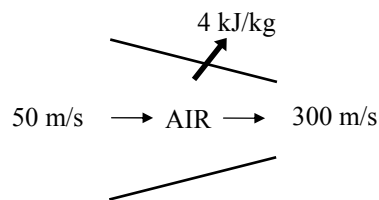

or

$$0 = q_{\text{out}} + h_2 - h_1 + \frac{V_2^2 - V_1^2}{2}$$

Therefore,

$$h_2 = h_1 - q_{\text{out}} - \frac{V_2^2 - V_1^2}{2} = 360.58 - 4 - \frac{(300 \text{ m/s})^2 - (50 \text{ m/s})^2}{2} \left( \frac{1 \text{ kJ/kg}}{1000 \text{ m}^2/\text{s}^2} \right) = 312.83 \text{ kJ/kg}$$

At this  $h_2$  value we read, from Table A-17,  $T_2 = 312.5 \text{ K} = 39.5^\circ\text{C}$  and  $s_2^0 = 1.74302 \text{ kJ/kg}\cdot\text{K}$

(b) The exergy destroyed during a process can be determined from an exergy balance or directly from its definition  $X_{\text{destroyed}} = T_0 S_{\text{gen}}$  where the entropy generation  $S_{\text{gen}}$  is determined from an entropy balance on an *extended system* that includes the device and its immediate surroundings so that the boundary temperature of the extended system is  $T_{\text{surr}}$  at all times. It gives

$$\underbrace{\dot{S}_{\text{in}} - \dot{S}_{\text{out}}}_{\text{Rate of net entropy transfer by heat and mass}} + \underbrace{\dot{S}_{\text{gen}}}_{\text{Rate of entropy generation}} = \underbrace{\Delta \dot{S}_{\text{system}}^{\neq 0}}_{\text{Rate of change of entropy}} = 0$$

$$ms_1 - ms_2 - \frac{\dot{Q}_{\text{out}}}{T_{\text{b,surr}}} + \dot{S}_{\text{gen}} = 0$$

$$\dot{S}_{\text{gen}} = \dot{m}(s_2 - s_1) + \frac{\dot{Q}_{\text{out}}}{T_{\text{surr}}}$$

where

$$\Delta s_{\text{air}} = s_2^0 - s_1^0 - R \ln \frac{P_2}{P_1}$$

$$= (1.74302 - 1.88543) \text{ kJ/kg}\cdot\text{K} - (0.287 \text{ kJ/kg}\cdot\text{K}) \ln \frac{95 \text{ kPa}}{300 \text{ kPa}} = 0.1876 \text{ kJ/kg}\cdot\text{K}$$

Substituting, the entropy generation and exergy destruction per unit mass of air are determined to be

$$\begin{aligned}
 x_{\text{destroyed}} &= T_0 \dot{S}_{\text{gen}} = T_{\text{surr}} \dot{S}_{\text{gen}} \\
 &= T_0 \left( s_2 - s_1 + \frac{q_{\text{surr}}}{T_{\text{surr}}} \right) = (290 \text{ K}) \left( 0.1876 \text{ kJ/kg} \cdot \text{K} + \frac{4 \text{ kJ/kg}}{290 \text{ K}} \right) = \mathbf{58.4 \text{ kJ/kg}}
 \end{aligned}$$

**Alternative solution** The exergy destroyed during a process can be determined from an exergy balance applied on the *extended system* that includes the device and its immediate surroundings so that the boundary temperature of the extended system is environment temperature  $T_0$  (or  $T_{\text{surr}}$ ) at all times. Noting that exergy transfer with heat is zero when the temperature at the point of transfer is the environment temperature, the exergy balance for this steady-flow system can be expressed as

$$\begin{aligned}
 \underbrace{\dot{X}_{\text{in}} - \dot{X}_{\text{out}}}_{\text{Rate of net exergy transfer by heat, work, and mass}} - \underbrace{\dot{X}_{\text{destroyed}}}_{\text{Rate of exergy destruction}} &= \underbrace{\Delta \dot{X}_{\text{system}}^{\phi_0} (\text{steady})}_{\text{Rate of change of exergy}} = 0 \rightarrow \dot{X}_{\text{destroyed}} = \dot{X}_{\text{in}} - \dot{X}_{\text{out}} = \dot{m} \psi_1 - \dot{m} \psi_2 = \dot{m} (\psi_1 - \psi_2) \\
 &= \dot{m} [(h_1 - h_2) - T_0 (s_1 - s_2) - \Delta ke - \Delta pe^{\phi_0}] = \dot{m} [T_0 (s_2 - s_1) - (h_2 - h_1 + \Delta ke)] \\
 &= \dot{m} [T_0 (s_2 - s_1) + q_{\text{out}}] \quad \text{since, from energy balance, } -q_{\text{out}} = h_2 - h_1 + \Delta ke \\
 &= T_0 \left( \dot{m} (s_2 - s_1) + \frac{\dot{Q}_{\text{out}}}{T_0} \right) = T_0 \dot{S}_{\text{gen}}
 \end{aligned}$$

Therefore, the two approaches for the determination of exergy destruction are identical.

**8-62 EES** Problem 8-61 is reconsidered. The effect of varying the nozzle exit velocity on the exit temperature and exergy destroyed is to be investigated.

**Analysis** The problem is solved using EES, and the solution is given below.

"Knowns:"

WorkFluid\$ = 'Air'

P[1] = 300 [kPa]

T[1] = 87 [C]

P[2] = 95 [kPa]

Vel[1] = 50 [m/s]

{Vel[2] = 300 [m/s]}

T\_o = 17 [C]

T\_surr = T\_o

q\_loss = 4 [kJ/kg]

"Conservation of Energy - SSSF energy balance for nozzle -- neglecting the change in potential energy:"

$h[1] = \text{enthalpy}(\text{WorkFluid}\$, T=T[1])$

$s[1] = \text{entropy}(\text{WorkFluid}\$, P=P[1], T=T[1])$

$ke[1] = \text{Vel}[1]^2/2$

$ke[2] = \text{Vel}[2]^2/2$

$h[1] + ke[1] * \text{convert}(m^2/s^2, kJ/kg) = h[2] + ke[2] * \text{convert}(m^2/s^2, kJ/kg) + q\_loss$

$T[2] = \text{temperature}(\text{WorkFluid}\$, h=h[2])$

$s[2] = \text{entropy}(\text{WorkFluid}\$, P=P[2], h=h[2])$

"The entropy generated is determined from the entropy balance:"

$s[1] - s[2] - q\_loss/(T\_surr+273) + s\_gen = 0$

$x\_destroyed = (T\_o+273)*s\_gen$

T <sub>2</sub> [C]	Vel <sub>2</sub> [m/s]	x <sub>destroyed</sub> [kJ/kg]
79.31	100	93.41
74.55	140	89.43
68.2	180	84.04
60.25	220	77.17
50.72	260	68.7
39.6	300	58.49

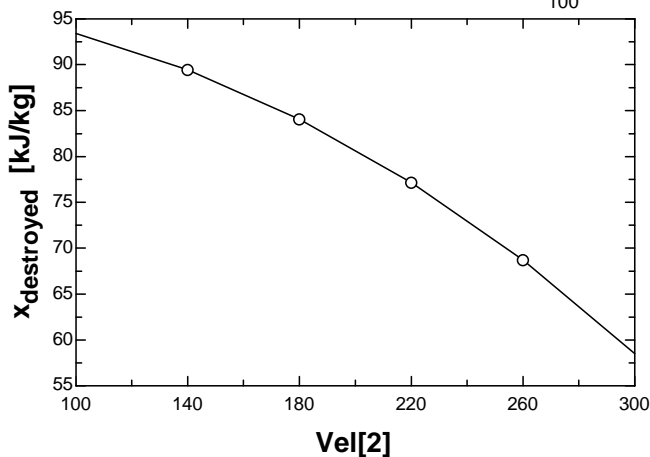
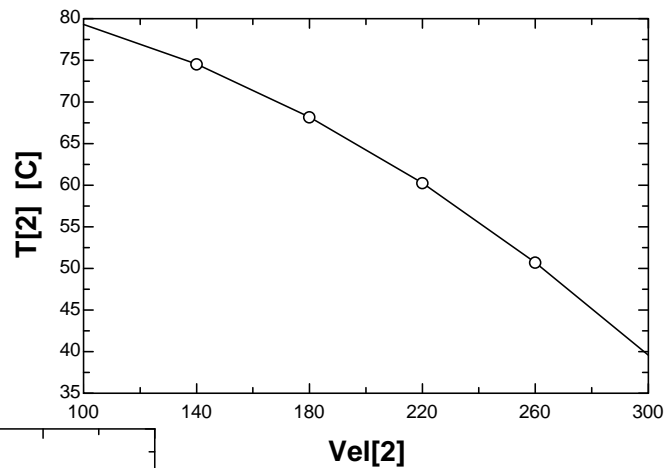

**8-63** Steam is decelerated in a diffuser. The mass flow rate of steam and the wasted work potential during the process are to be determined.

**Assumptions 1** The diffuser operates steadily. **2** The changes in potential energies are negligible.

**Properties** The properties of steam at the inlet and the exit of the diffuser are (Tables A-4 through A-6)

$$\left. \begin{array}{l} P_1 = 10 \text{ kPa} \\ T_1 = 50^\circ\text{C} \end{array} \right\} \begin{array}{l} h_1 = 2592.0 \text{ kJ/kg} \\ s_1 = 8.1741 \text{ kJ/kg}\cdot\text{K} \end{array}$$

$$\left. \begin{array}{l} T_2 = 50^\circ\text{C} \\ \text{sat. vapor} \end{array} \right\} \begin{array}{l} h_2 = 2591.3 \text{ kJ/kg} \\ s_2 = 8.0748 \text{ kJ/kg}\cdot\text{K} \\ v_2 = 12.026 \text{ m}^3/\text{kg} \end{array}$$

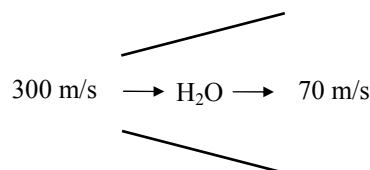

**Analysis** (a) The mass flow rate of the steam is

$$\dot{m} = \frac{1}{v_2} A_2 V_2 = \frac{1}{12.026 \text{ m}^3/\text{kg}} (3 \text{ m}^2)(70 \text{ m/s}) = \mathbf{17.46 \text{ kg/s}}$$

(b) We take the diffuser to be the system, which is a control volume. Assuming the direction of heat transfer to be from the stem, the energy balance for this steady-flow system can be expressed in the rate form as

$$\underbrace{\dot{E}_{\text{in}} - \dot{E}_{\text{out}}}_{\text{Rate of net energy transfer by heat, work, and mass}} = \underbrace{\Delta \dot{E}_{\text{system}}^{\phi_0}}_{\text{Rate of change in internal, kinetic, potential, etc. energies (steady)}} = 0$$

$$\dot{E}_{\text{in}} = \dot{E}_{\text{out}}$$

$$\dot{m}(h_1 + V_1^2/2) = \dot{m}(h_2 + V_2^2/2) + \dot{Q}_{\text{out}}$$

$$\dot{Q}_{\text{out}} = -\dot{m} \left( h_2 - h_1 + \frac{V_2^2 - V_1^2}{2} \right)$$

Substituting,

$$\dot{Q}_{\text{out}} = -(17.46 \text{ kg/s}) \left[ 2591.3 - 2592.0 + \frac{(70 \text{ m/s})^2 - (300 \text{ m/s})^2}{2} \left( \frac{1 \text{ kJ/kg}}{1000 \text{ m}^2/\text{s}^2} \right) \right] = 754.8 \text{ kJ/s}$$

The wasted work potential is equivalent to exergy destruction. The exergy destroyed during a process can be determined from an exergy balance or directly from its definition  $X_{\text{destroyed}} = T_0 \dot{S}_{\text{gen}}$  where the entropy generation  $\dot{S}_{\text{gen}}$  is determined from an entropy balance on an *extended system* that includes the device and its immediate surroundings so that the boundary temperature of the extended system is  $T_{\text{surr}}$  at all times. It gives

$$\underbrace{\dot{S}_{\text{in}} - \dot{S}_{\text{out}}}_{\text{Rate of net entropy transfer by heat and mass}} + \underbrace{\dot{S}_{\text{gen}}}_{\text{Rate of entropy generation}} = \underbrace{\Delta \dot{S}_{\text{system}}^{\phi_0}}_{\text{Rate of change of entropy}} = 0$$

$$\dot{m}s_1 - \dot{m}s_2 - \frac{\dot{Q}_{\text{out}}}{T_{\text{b,surr}}} + \dot{S}_{\text{gen}} = 0 \rightarrow \dot{S}_{\text{gen}} = \dot{m}(s_2 - s_1) + \frac{\dot{Q}_{\text{out}}}{T_{\text{surr}}}$$

Substituting, the exergy destruction is determined to be

$$\begin{aligned} \dot{X}_{\text{destroyed}} &= T_0 \dot{S}_{\text{gen}} = T_0 \left( \dot{m}(s_2 - s_1) + \frac{\dot{Q}_{\text{out}}}{T_0} \right) \\ &= (298 \text{ K}) \left( (17.46 \text{ kg/s})(8.0748 - 8.1741) \text{ kJ/kg}\cdot\text{K} + \frac{754.8 \text{ kW}}{298 \text{ K}} \right) = \mathbf{238.3 \text{ kW}} \end{aligned}$$



**8-64E** Air is compressed steadily by a compressor from a specified state to another specified state. The minimum power input required for the compressor is to be determined.

**Assumptions 1** Air is an ideal gas with variable specific heats. **2** Kinetic and potential energy changes are negligible.

**Properties** The gas constant of air is  $R = 0.06855 \text{ Btu/lbm}\cdot\text{R}$  (Table A-1E). From the air table (Table A-17E)

$$T_1 = 520 \text{ R} \longrightarrow h_1 = 124.27 \text{ Btu/lbm}$$

$$s_1^0 = 0.59173 \text{ Btu/lbm}\cdot\text{R}$$

$$T_2 = 940 \text{ R} \longrightarrow h_2 = 226.11 \text{ Btu/lbm}$$

$$s_2^0 = 0.73509 \text{ Btu/lbm}\cdot\text{R}$$

**Analysis** The reversible (or minimum) power input is determined from the rate form of the exergy balance applied on the compressor and setting the exergy destruction term equal to zero,

$$\underbrace{\dot{X}_{\text{in}} - \dot{X}_{\text{out}}}_{\text{Rate of net exergy transfer by heat, work, and mass}} - \underbrace{\dot{X}_{\text{destroyed}}}_{\text{Rate of exergy destruction}} \stackrel{\text{reversible}}{=} \underbrace{\Delta \dot{X}_{\text{system}}}_{\text{Rate of change of exergy}} \stackrel{\text{steady}}{=} 0$$

$$\dot{X}_{\text{in}} = \dot{X}_{\text{out}}$$

$$\dot{m}\psi_1 + \dot{W}_{\text{rev,in}} = \dot{m}\psi_2$$

$$\dot{W}_{\text{rev,in}} = \dot{m}(\psi_2 - \psi_1) = \dot{m}[(h_2 - h_1) - T_0(s_2 - s_1) + \Delta ke^{\text{re}} + \Delta pe^{\text{re}}]$$

where

$$\begin{aligned} \Delta s_{\text{air}} &= s_2^0 - s_1^0 - R \ln \frac{P_2}{P_1} \\ &= (0.73509 - 0.59173) \text{ Btu/lbm}\cdot\text{R} - (0.06855 \text{ Btu/lbm}\cdot\text{R}) \ln \frac{100 \text{ psia}}{14.7 \text{ psia}} \\ &= 0.01193 \text{ Btu/lbm}\cdot\text{R} \end{aligned}$$

Substituting,

$$\begin{aligned} \dot{W}_{\text{rev,in}} &= (22/60 \text{ lbm/s})[(226.11 - 124.27) \text{ Btu/lbm} - (520 \text{ R})(0.01193 \text{ Btu/lbm}\cdot\text{R})] \\ &= 35.1 \text{ Btu/s} = \mathbf{49.6 \text{ hp}} \end{aligned}$$

**Discussion** Note that this is the minimum power input needed for this compressor.

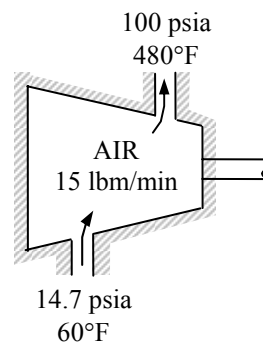

**8-65** Steam expands in a turbine from a specified state to another specified state. The actual power output of the turbine is given. The reversible power output and the second-law efficiency are to be determined.

**Assumptions 1** This is a steady-flow process since there is no change with time. **2** Kinetic and potential energy changes are negligible. **3** The temperature of the surroundings is given to be 25°C.

**Properties** From the steam tables (Tables A-4 through A-6)

$$\left. \begin{array}{l} P_1 = 6 \text{ MPa} \\ T_1 = 600^\circ\text{C} \end{array} \right\} \begin{array}{l} h_1 = 3658.8 \text{ kJ/kg} \\ s_1 = 7.1693 \text{ kJ/kg} \cdot \text{K} \end{array}$$

$$\left. \begin{array}{l} P_2 = 50 \text{ kPa} \\ T_2 = 100^\circ\text{C} \end{array} \right\} \begin{array}{l} h_2 = 2682.4 \text{ kJ/kg} \\ s_2 = 7.6953 \text{ kJ/kg} \cdot \text{K} \end{array}$$

**Analysis (b)** There is only one inlet and one exit, and thus  $\dot{m}_1 = \dot{m}_2 = \dot{m}$ . We take the turbine as the system, which is a control volume since mass crosses the boundary. The energy balance for this steady-flow system can be expressed in the rate form as

$$\underbrace{\dot{E}_{\text{in}} - \dot{E}_{\text{out}}}_{\text{Rate of net energy transfer by heat, work, and mass}} = \underbrace{\Delta \dot{E}_{\text{system}}^{\text{00}}}_{\text{Rate of change in internal, kinetic, potential, etc. energies}} \stackrel{\text{00 (steady)}}{=} 0$$

$$\dot{E}_{\text{in}} = \dot{E}_{\text{out}}$$

$$\dot{m}(h_1 + V_1^2/2) = \dot{W}_{\text{out}} + \dot{m}(h_2 + V_2^2/2)$$

$$\dot{W}_{\text{out}} = \dot{m} \left[ h_1 - h_2 + \frac{V_1^2 - V_2^2}{2} \right]$$

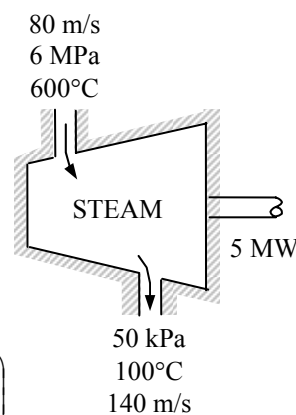

Substituting,

$$5000 \text{ kJ/s} = \dot{m} \left( 3658.8 - 2682.4 + \frac{(80 \text{ m/s})^2 - (140 \text{ m/s})^2}{2} \left( \frac{1 \text{ kJ/kg}}{1000 \text{ m}^2/\text{s}^2} \right) \right)$$

$$\dot{m} = 5.156 \text{ kg/s}$$

The reversible (or maximum) power output is determined from the rate form of the exergy balance applied on the turbine and setting the exergy destruction term equal to zero,

$$\underbrace{\dot{X}_{\text{in}} - \dot{X}_{\text{out}}}_{\text{Rate of net exergy transfer by heat, work, and mass}} - \underbrace{\dot{X}_{\text{destroyed}}^{\text{00}}}_{\text{Rate of exergy destruction}} \stackrel{\text{00 (reversible)}}{=} \underbrace{\Delta \dot{X}_{\text{system}}^{\text{00}}}_{\text{Rate of change of exergy}} \stackrel{\text{00 (steady)}}{=} 0$$

$$\dot{X}_{\text{in}} = \dot{X}_{\text{out}}$$

$$\dot{m}\psi_1 = \dot{W}_{\text{rev,out}} + \dot{m}\psi_2$$

$$\dot{W}_{\text{rev,out}} = \dot{m}(\psi_1 - \psi_2) = \dot{m}[(h_1 - h_2) - T_0(s_1 - s_2) - \Delta ke^{\text{00}} - \Delta pe^{\text{00}}]$$

Substituting,

$$\begin{aligned} \dot{W}_{\text{rev,out}} &= \dot{m}[(h_1 - h_2) - T_0(s_1 - s_2)] \\ &= (5.156 \text{ kg/s})[3658.8 - 2682.4 - (298 \text{ K})(7.1693 - 7.6953) \text{ kJ/kg} \cdot \text{K}] = \mathbf{5842 \text{ kW}} \end{aligned}$$

(b) The second-law efficiency of a turbine is the ratio of the actual work output to the reversible work,

$$\eta_{\text{II}} = \frac{\dot{W}_{\text{out}}}{\dot{W}_{\text{rev,out}}} = \frac{5 \text{ MW}}{5.842 \text{ MW}} = \mathbf{85.6\%}$$

**Discussion** Note that 14.4% percent of the work potential of the steam is wasted as it flows through the turbine during this process.

**8-66** Steam is throttled from a specified state to a specified pressure. The decrease in the exergy of the steam during this throttling process is to be determined.

**Assumptions** **1** This is a steady-flow process since there is no change with time. **2** Kinetic and potential energy changes are negligible. **3** The temperature of the surroundings is given to be 25°C. **4** Heat transfer is negligible.

**Properties** The properties of steam before and after throttling are (Tables A-4 through A-6)

$$\left. \begin{array}{l} P_1 = 9 \text{ MPa} \\ T_1 = 500^\circ\text{C} \end{array} \right\} \begin{array}{l} h_1 = 3387.4 \text{ kJ/kg} \\ s_1 = 6.6603 \text{ kJ/kg} \cdot \text{K} \end{array}$$

$$\left. \begin{array}{l} P_2 = 7 \text{ MPa} \\ h_2 = h_1 \end{array} \right\} s_2 = 6.7687 \text{ kJ/kg} \cdot \text{K}$$

**Analysis** The decrease in exergy is of the steam is the difference between the inlet and exit flow exergies,

$$\begin{aligned} \text{Decrease in exergy} &= \psi_1 - \psi_2 = -[\Delta h^{\text{ex}} - \Delta ke^{\text{ex}} - \Delta pe^{\text{ex}} - T_0(s_1 - s_2)] = T_0(s_2 - s_1) \\ &= (298 \text{ K})(6.7687 - 6.6603) \text{ kJ/kg} \cdot \text{K} \\ &= \mathbf{32.3 \text{ kJ/kg}} \end{aligned}$$

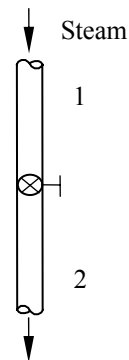

**Discussion** Note that 32.3 kJ/kg of work potential is wasted during this throttling process.

**8-67** Combustion gases expand in a turbine from a specified state to another specified state. The exergy of the gases at the inlet and the reversible work output of the turbine are to be determined.

**Assumptions** **1** This is a steady-flow process since there is no change with time. **2** Potential energy changes are negligible. **3** The temperature of the surroundings is given to be 25°C. **4** The combustion gases are ideal gases with constant specific heats.

**Properties** The constant pressure specific heat and the specific heat ratio are given to be  $c_p = 1.15 \text{ kJ/kg}\cdot\text{K}$  and  $k = 1.3$ . The gas constant  $R$  is determined from

$$R = c_p - c_v = c_p - c_p / k = c_p (1 - 1/k) = (1.15 \text{ kJ/kg}\cdot\text{K})(1 - 1/1.3) = 0.265 \text{ kJ/kg}\cdot\text{K}$$

**Analysis** (a) The exergy of the gases at the turbine inlet is simply the flow exergy,

$$\psi_1 = h_1 - h_0 - T_0 (s_1 - s_0) + \frac{V_1^2}{2} + gz_1^{\text{ex}}$$

where

$$\begin{aligned} s_1 - s_0 &= c_p \ln \frac{T_1}{T_0} - R \ln \frac{P_1}{P_0} \\ &= (1.15 \text{ kJ/kg}\cdot\text{K}) \ln \frac{1173 \text{ K}}{298 \text{ K}} - (0.265 \text{ kJ/kg}\cdot\text{K}) \ln \frac{800 \text{ kPa}}{100 \text{ kPa}} \\ &= 1.025 \text{ kJ/kg}\cdot\text{K} \end{aligned}$$

Thus,

$$\psi_1 = (1.15 \text{ kJ/kg}\cdot\text{K})(900 - 25)^\circ\text{C} - (298 \text{ K})(1.025 \text{ kJ/kg}\cdot\text{K}) + \frac{(100 \text{ m/s})^2}{2} \left( \frac{1 \text{ kJ/kg}}{1000 \text{ m}^2/\text{s}^2} \right) = \mathbf{705.8 \text{ kJ/kg}}$$

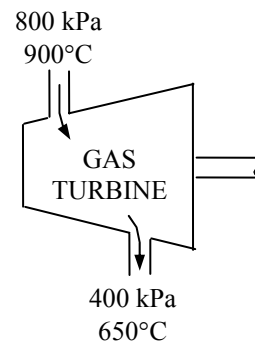

(b) The reversible (or maximum) work output is determined from an exergy balance applied on the turbine and setting the exergy destruction term equal to zero,

$$\begin{aligned} \underbrace{\dot{X}_{\text{in}} - \dot{X}_{\text{out}}}_{\text{Rate of net exergy transfer by heat, work, and mass}} - \underbrace{\dot{X}_{\text{destroyed}}^{\text{ex}}}_{\text{Rate of exergy destruction}} &= \underbrace{\Delta \dot{X}_{\text{system}}^{\text{ex}}}_{\text{Rate of change of exergy}} = 0 \\ \dot{X}_{\text{in}} &= \dot{X}_{\text{out}} \\ \dot{m} \psi_1 &= \dot{W}_{\text{rev, out}} + \dot{m} \psi_2 \\ \dot{W}_{\text{rev, out}} &= \dot{m}(\psi_1 - \psi_2) = \dot{m}[(h_1 - h_2) - T_0(s_1 - s_2) - \Delta \text{ke} - \Delta \text{pe}^{\text{ex}}] \end{aligned}$$

where

$$\Delta \text{ke} = \frac{V_2^2 - V_1^2}{2} = \frac{(220 \text{ m/s})^2 - (100 \text{ m/s})^2}{2} \left( \frac{1 \text{ kJ/kg}}{1000 \text{ m}^2/\text{s}^2} \right) = 19.2 \text{ kJ/kg}$$

and

$$\begin{aligned} s_2 - s_1 &= c_p \ln \frac{T_2}{T_1} - R \ln \frac{P_2}{P_1} \\ &= (1.15 \text{ kJ/kg}\cdot\text{K}) \ln \frac{923 \text{ K}}{1173 \text{ K}} - (0.265 \text{ kJ/kg}\cdot\text{K}) \ln \frac{400 \text{ kPa}}{800 \text{ kPa}} \\ &= -0.09196 \text{ kJ/kg}\cdot\text{K} \end{aligned}$$

Then the reversible work output on a unit mass basis becomes

$$\begin{aligned} w_{\text{rev, out}} &= h_1 - h_2 + T_0 (s_2 - s_1) - \Delta \text{ke} = c_p (T_1 - T_2) + T_0 (s_2 - s_1) - \Delta \text{ke} \\ &= (1.15 \text{ kJ/kg}\cdot\text{K})(900 - 650)^\circ\text{C} + (298 \text{ K})(-0.09196 \text{ kJ/kg}\cdot\text{K}) - 19.2 \text{ kJ/kg} = \mathbf{240.9 \text{ kJ/kg}} \end{aligned}$$

**8-68E** Refrigerant-134a enters an adiabatic compressor with an isentropic efficiency of 0.80 at a specified state with a specified volume flow rate, and leaves at a specified pressure. The actual power input and the second-law efficiency to the compressor are to be determined.

**Assumptions 1** This is a steady-flow process since there is no change with time. **2** Kinetic and potential energy changes are negligible. **3** The device is adiabatic and thus heat transfer is negligible.

**Properties** From the refrigerant tables (Tables A-11E through A-13E)

$$P_1 = 30 \text{ psia} \left. \begin{array}{l} h_1 = h_{g@30 \text{ psia}} = 105.32 \text{ Btu/lbm} \\ s_1 = s_{g@30 \text{ psia}} = 0.2238 \text{ Btu/lbm} \cdot \text{R} \\ \nu_1 = \nu_{g@30 \text{ psia}} = 1.5492 \text{ ft}^3/\text{lbm} \end{array} \right\} \text{ sat. vapor} \quad P_2 = 70 \text{ psia} \left. \begin{array}{l} h_{2s} = 112.80 \text{ Btu/lbm} \\ s_{2s} = s_1 \end{array} \right\}$$

**Analysis** From the isentropic efficiency relation,

$$\eta_c = \frac{h_{2s} - h_1}{h_{2a} - h_1} \longrightarrow h_{2a} = h_1 + (h_{2s} - h_1) / \eta_c \\ = 105.32 + (112.80 - 105.32) / 0.80 \\ = 114.67 \text{ Btu/lbm}$$

Then,

$$P_2 = 70 \text{ psia} \left. \begin{array}{l} h_{2a} = 114.67 \end{array} \right\} s_2 = 0.2274 \text{ Btu/lbm}$$

$$\text{Also, } \dot{m} = \frac{\dot{V}_1}{\nu_1} = \frac{20 / 60 \text{ ft}^3 / \text{s}}{1.5492 \text{ ft}^3 / \text{lbm}} = 0.2152 \text{ lbm/s}$$

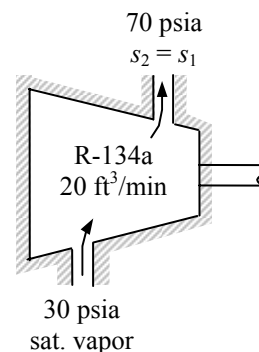

There is only one inlet and one exit, and thus  $\dot{m}_1 = \dot{m}_2 = \dot{m}$ . We take the actual compressor as the system, which is a control volume. The energy balance for this steady-flow system can be expressed as

$$\underbrace{\dot{E}_{\text{in}} - \dot{E}_{\text{out}}}_{\text{Rate of net energy transfer by heat, work, and mass}} = \underbrace{\Delta \dot{E}_{\text{system}}^{\text{0 (steady)}}}_{\text{Rate of change in internal, kinetic, potential, etc. energies}} = 0 \\ \dot{E}_{\text{in}} = \dot{E}_{\text{out}} \\ \dot{W}_{a,\text{in}} + \dot{m}h_1 = \dot{m}h_2 \quad (\text{since } \dot{Q} \cong \Delta ke \cong \Delta pe \cong 0) \\ \dot{W}_{a,\text{in}} = \dot{m}(h_2 - h_1)$$

Substituting, the actual power input to the compressor becomes

$$\dot{W}_{a,\text{in}} = (0.2152 \text{ lbm/s})(114.67 - 105.32) \text{ Btu/lbm} \left( \frac{1 \text{ hp}}{0.7068 \text{ Btu/s}} \right) = \mathbf{2.85 \text{ hp}}$$

(b) The reversible (or minimum) power input is determined from the exergy balance applied on the compressor and setting the exergy destruction term equal to zero,

$$\underbrace{\dot{X}_{\text{in}} - \dot{X}_{\text{out}}}_{\text{Rate of net exergy transfer by heat, work, and mass}} - \underbrace{\dot{X}_{\text{destroyed}}^{\text{0 (reversible)}}}_{\text{Rate of exergy destruction}} = \underbrace{\Delta \dot{X}_{\text{system}}^{\text{0 (steady)}}}_{\text{Rate of change of exergy}} = 0 \\ \dot{X}_{\text{in}} = \dot{X}_{\text{out}} \\ \dot{W}_{\text{rev},\text{in}} + \dot{m}\psi_1 = \dot{m}\psi_2 \\ \dot{W}_{\text{rev},\text{in}} = \dot{m}(\psi_2 - \psi_1) = \dot{m}[(h_2 - h_1) - T_0(s_2 - s_1) + \Delta ke^{\text{0}} + \Delta pe^{\text{0}}]$$

Substituting,

$$\dot{W}_{\text{rev},\text{in}} = (0.2152 \text{ lbm/s})[(114.67 - 105.32) \text{ Btu/lbm} - (535 \text{ R})(0.2274 - 0.2238) \text{ Btu/lbm} \cdot \text{R}] \\ = 1.606 \text{ Btu/s} = \mathbf{2.27 \text{ hp}} \quad (\text{since } 1 \text{ hp} = 0.7068 \text{ Btu/s})$$

$$\text{Thus, } \eta_{\text{II}} = \frac{\dot{W}_{\text{rev},\text{in}}}{\dot{W}_{\text{act},\text{in}}} = \frac{2.27 \text{ hp}}{2.85 \text{ hp}} = \mathbf{79.8\%}$$

**8-69** Refrigerant-134a is compressed by an adiabatic compressor from a specified state to another specified state. The isentropic efficiency and the second-law efficiency of the compressor are to be determined.

**Assumptions 1** This is a steady-flow process since there is no change with time. **2** Kinetic and potential energy changes are negligible. **3** The device is adiabatic and thus heat transfer is negligible.

**Properties** From the refrigerant tables (Tables A-11E through A-13E)

$$\left. \begin{array}{l} P_1 = 140 \text{ kPa} \\ T_1 = -10^\circ\text{C} \end{array} \right\} \begin{array}{l} h_1 = 246.36 \text{ kJ/kg} \\ s_1 = 0.97236 \text{ kJ/kg} \cdot \text{K} \\ \nu_1 = 0.14605 \text{ m}^3/\text{kg} \end{array}$$

$$\left. \begin{array}{l} P_2 = 700 \text{ kPa} \\ T_2 = 60^\circ\text{C} \end{array} \right\} \begin{array}{l} h_2 = 298.42 \text{ kJ/kg} \\ s_2 = 1.0256 \text{ kJ/kg} \cdot \text{K} \end{array}$$

$$\left. \begin{array}{l} P_{2s} = 700 \text{ kPa} \\ s_{2s} = s_1 \end{array} \right\} h_{2s} = 281.16 \text{ kJ/kg}$$

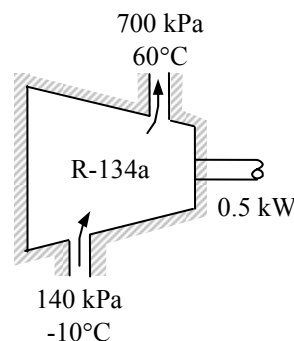

**Analysis (a)** The isentropic efficiency is

$$\eta_c = \frac{h_{2s} - h_1}{h_{2a} - h_1} = \frac{281.16 - 246.36}{298.42 - 246.36} = 0.668 = \mathbf{66.8\%}$$

**(b)** There is only one inlet and one exit, and thus  $\dot{m}_1 = \dot{m}_2 = \dot{m}$ . We take the actual compressor as the system, which is a control volume. The energy balance for this steady-flow system can be expressed as

$$\underbrace{\dot{E}_{\text{in}} - \dot{E}_{\text{out}}}_{\text{Rate of net energy transfer by heat, work, and mass}} = \underbrace{\Delta \dot{E}_{\text{system}}^{\infty 0} (\text{steady})}_{\text{Rate of change in internal, kinetic, potential, etc. energies}} = 0$$

$$\dot{E}_{\text{in}} = \dot{E}_{\text{out}}$$

$$\dot{W}_{a,\text{in}} + \dot{m}h_1 = \dot{m}h_2 \quad (\text{since } \dot{Q} \cong \Delta ke \cong \Delta pe \cong 0)$$

$$\dot{W}_{a,\text{in}} = \dot{m}(h_2 - h_1)$$

Then the mass flow rate of the refrigerant becomes

$$\dot{m} = \frac{\dot{W}_{a,\text{in}}}{h_{2a} - h_1} = \frac{0.5 \text{ kJ/s}}{(298.42 - 246.36) \text{ kJ/kg}} = 0.009603 \text{ kg/s}$$

The reversible (or minimum) power input is determined from the exergy balance applied on the compressor and setting the exergy destruction term equal to zero,

$$\underbrace{\dot{X}_{\text{in}} - \dot{X}_{\text{out}}}_{\text{Rate of net exergy transfer by heat, work, and mass}} - \underbrace{\dot{X}_{\text{destroyed}}^{\infty 0} (\text{reversible})}_{\text{Rate of exergy destruction}} = \underbrace{\Delta \dot{X}_{\text{system}}^{\infty 0} (\text{steady})}_{\text{Rate of change of exergy}} = 0$$

$$\dot{X}_{\text{in}} = \dot{X}_{\text{out}}$$

$$\dot{W}_{\text{rev},\text{in}} + \dot{m}\psi_1 = \dot{m}\psi_2$$

$$\dot{W}_{\text{rev},\text{in}} = \dot{m}(\psi_2 - \psi_1) = \dot{m}[(h_2 - h_1) - T_0(s_2 - s_1) + \Delta ke^{\infty 0} + \Delta pe^{\infty 0}]$$

Substituting,

$$\dot{W}_{\text{rev},\text{in}} = (0.009603 \text{ kg/s}) [(298.42 - 246.36) \text{ kJ/kg} - (300 \text{ K})(1.0256 - 0.97236) \text{ kJ/kg} \cdot \text{K}] = 0.347 \text{ kW}$$

and

$$\eta_{\text{II}} = \frac{\dot{W}_{\text{rev},\text{in}}}{\dot{W}_{a,\text{in}}} = \frac{0.347 \text{ kW}}{0.5 \text{ kW}} = \mathbf{69.3\%}$$

**8-70** Air is compressed steadily by a compressor from a specified state to another specified state. The increase in the exergy of air and the rate of exergy destruction are to be determined.

**Assumptions 1** Air is an ideal gas with variable specific heats. **2** Kinetic and potential energy changes are negligible.

**Properties** The gas constant of air is  $R = 0.287 \text{ kJ/kg}\cdot\text{K}$  (Table A-1).  
From the air table (Table A-17)

$$T_1 = 300 \text{ K} \longrightarrow h_1 = 300.19 \text{ kJ/kg}$$

$$s_1^\circ = 1.702 \text{ kJ/kg}\cdot\text{K}$$

$$T_2 = 550 \text{ K} \longrightarrow h_2 = 555.74 \text{ kJ/kg}$$

$$s_2^\circ = 2.318 \text{ kJ/kg}\cdot\text{K}$$

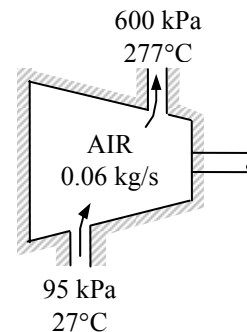

**Analysis** The reversible (or minimum) power input is determined from the rate form of the exergy balance applied on the compressor and setting the exergy destruction term equal to zero,

$$\underbrace{\dot{X}_{\text{in}} - \dot{X}_{\text{out}}}_{\text{Rate of net exergy transfer by heat, work, and mass}} - \underbrace{\dot{X}_{\text{destroyed}}^{\text{rev}}}_{\text{Rate of exergy destruction}} = \underbrace{\Delta\dot{X}_{\text{system}}^{\text{rev}}}_{\text{Rate of change of exergy}} = 0$$

$$\dot{X}_{\text{in}} = \dot{X}_{\text{out}}$$

$$\dot{m}\psi_1 + \dot{W}_{\text{rev, in}} = \dot{m}\psi_2$$

$$\dot{W}_{\text{rev, in}} = \dot{m}(\psi_2 - \psi_1) = \dot{m}[(h_2 - h_1) - T_0(s_2 - s_1) + \Delta\text{ke}^{\text{rev}} + \Delta\text{pe}^{\text{rev}}]$$

where

$$s_2 - s_1 = s_2^\circ - s_1^\circ - R \ln \frac{P_2}{P_1}$$

$$= (2.318 - 1.702) \text{ kJ/kg}\cdot\text{K} - (0.287 \text{ kJ/kg}\cdot\text{K}) \ln \frac{600 \text{ kPa}}{95 \text{ kPa}}$$

$$= 0.0870 \text{ kJ/kg}\cdot\text{K}$$

Substituting,

$$\dot{W}_{\text{rev, in}} = (0.06 \text{ kg/s})[(555.74 - 300.19) \text{ kJ/kg} - (298 \text{ K})(0.0870 \text{ kJ/kg}\cdot\text{K})] = \mathbf{13.7 \text{ kW}}$$

**Discussion** Note that a minimum of 13.7 kW of power input is needed for this compression process.

**8-71 EES** Problem 8-70 is reconsidered. The effect of compressor exit pressure on reversible power is to be investigated.

**Analysis** The problem is solved using EES, and the solution is given below.

```
T_1=27 [C]
P_1=95 [kPa]
m_dot = 0.06 [kg/s]
{P_2=600 [kPa]}
T_2=277 [C]
T_o=25 [C]
P_o=100 [kPa]
m_dot_in=m_dot
```

"Steady-flow conservation of mass"

```
m_dot_in = m_dot_out
h_1 =enthalpy(air,T=T_1)
h_2 = enthalpy(air, T=T_2)
W_dot_rev=m_dot_in*(h_2 - h_1 -(T_1+273.15)*(s_2-s_1))
s_1=entropy(air, T=T_1,P=P_1)
s_2=entropy(air,T=T_2,P=P_2)
```

P <sub>2</sub> [kPa]	W <sub>rev</sub> [kW]
200	8.025
250	9.179
300	10.12
350	10.92
400	11.61
450	12.22
500	12.76
550	13.25
600	13.7

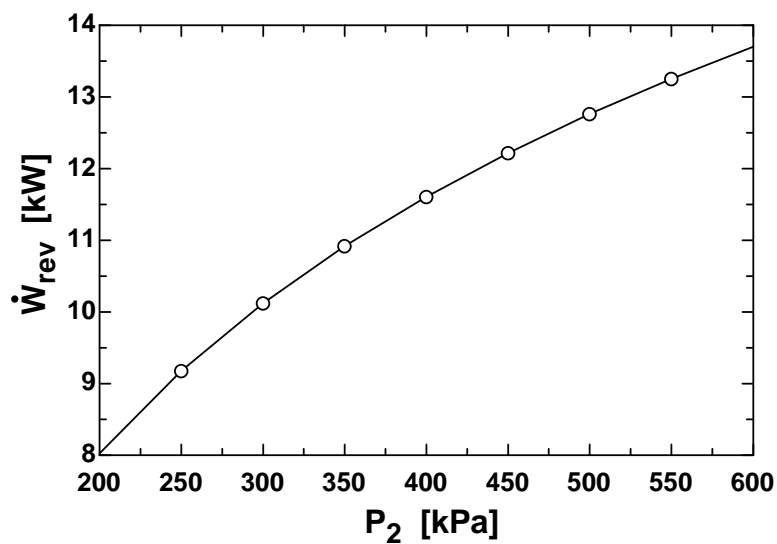



**8-72** An expression is to be derived for the work potential of the single-phase contents of a rigid adiabatic container when the initially empty container is filled through a single opening from a source of working fluid whose properties remain fixed.

**Analysis** The conservation of mass principle for this system reduces to

$$\frac{dm_{CV}}{dt} = \dot{m}_i$$

where the subscript  $i$  stands for the inlet state. When the entropy generation is set to zero (for calculating work potential) and the combined first and second law is reduced to fit this system, it becomes

$$\dot{W}_{rev} = -\frac{d(U - T_0 S)}{dt} + (h - T_0 S)_i \dot{m}_i$$

When these are combined, the result is

$$\dot{W}_{rev} = -\frac{d(U - T_0 S)}{dt} + (h - T_0 S)_i \frac{dm_{CV}}{dt}$$

Recognizing that there is no initial mass in the system, integration of the above equation produces

$$W_{rev} = (h - T_0 s)_i m_2 - m_2 (h_2 - T_0 s_2)$$

$$\frac{W_{rev}}{m_2} = (h_i - h_2) - T_0 (s_i - s_2)$$

where the subscript 2 stands for the final state in the container.

**8-73** A rigid tank initially contains saturated liquid of refrigerant-134a. R-134a is released from the vessel until no liquid is left in the vessel. The reversible work associated with this process is to be determined.

**Assumptions 1** This is an unsteady process since the conditions within the device are changing during the process. It can be analyzed as a uniform-flow process since the state of fluid leaving the device remains constant. **2** Kinetic and potential energies are negligible. **3** There are no work interactions involved.

**Properties** The properties of R-134a are (Tables A-11 through A-13)

$$\begin{array}{l}
 T_1 = 20^\circ\text{C} \\
 \text{sat. liquid}
 \end{array}
 \left.
 \begin{array}{l}
 \nu_1 = \nu_f @ 20^\circ\text{C} = 0.0008161 \text{ m}^3 / \text{kg} \\
 u_1 = u_f @ 20^\circ\text{C} = 78.86 \text{ kJ/kg} \\
 s_1 = s_f @ 20^\circ\text{C} = 0.30063 \text{ kJ/kg} \cdot \text{K}
 \end{array}
 \right\}$$

$$\begin{array}{l}
 T_2 = 20^\circ\text{C} \\
 \text{sat. vapor}
 \end{array}
 \left.
 \begin{array}{l}
 \nu_2 = \nu_g @ 20^\circ\text{C} = 0.035969 \text{ m}^3 / \text{kg} \\
 u_2 = u_g @ 20^\circ\text{C} = 241.02 \text{ kJ/kg} \\
 s_2 = s_e = s_g @ 20^\circ\text{C} = 0.92234 \text{ kJ/kg} \cdot \text{K} \\
 h_e = h_g @ 20^\circ\text{C} = 261.59 \text{ kJ/kg}
 \end{array}
 \right\}$$

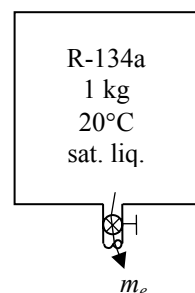

**Analysis** The volume of the container is

$$\mathcal{V} = m_1 \nu_1 = (1 \text{ kg})(0.0008161 \text{ m}^3/\text{kg}) = 0.0008161 \text{ m}^3$$

The mass in the container at the final state is

$$m_2 = \frac{\mathcal{V}}{\nu_2} = \frac{0.0008161 \text{ m}^3}{0.035969 \text{ m}^3/\text{kg}} = 0.02269 \text{ kg}$$

The amount of mass leaving the container is

$$m_e = m_1 - m_2 = 1 - 0.02269 = 0.9773 \text{ kg}$$

The exergy destroyed during a process can be determined from an exergy balance or directly from its definition  $X_{\text{destroyed}} = T_0 S_{\text{gen}}$ . The entropy generation  $S_{\text{gen}}$  in this case is determined from an entropy balance on the system:

$$\underbrace{S_{\text{in}} - S_{\text{out}}}_{\substack{\text{Net entropy transfer} \\ \text{by heat and mass}}} + \underbrace{S_{\text{gen}}}_{\substack{\text{Entropy} \\ \text{generation}}} = \underbrace{\Delta S_{\text{system}}}_{\substack{\text{Change} \\ \text{in entropy}}}$$

$$-m_e s_e + S_{\text{gen}} = \Delta S_{\text{tank}} = (m_2 s_2 - m_1 s_1)_{\text{tank}}$$

$$S_{\text{gen}} = m_2 s_2 - m_1 s_1 + m_e s_e$$

Substituting,

$$\begin{aligned}
 X_{\text{destroyed}} &= T_0 S_{\text{gen}} = T_0 (m_2 s_2 - m_1 s_1 + m_e s_e) \\
 &= (293 \text{ K})(0.02269 \times 0.92234 - 1 \times 0.30063 + 0.9773 \times 0.92234) \\
 &= \mathbf{182.2 \text{ kJ}}
 \end{aligned}$$

**8-74** An adiabatic rigid tank that is initially evacuated is filled by air from a supply line. The work potential associated with this process is to be determined.

**Assumptions 1** This is an unsteady process since the conditions within the device are changing during the process. It can be analyzed as a uniform-flow process since the state of fluid entering the device remains constant. **2** Kinetic and potential energies are negligible. **3** There are no work interactions involved. **4** Air is an ideal gas with constant specific heats.

**Properties** The properties of air at room temperature are  $c_p = 0.240$  Btu/lbm·R and  $R = 0.06855$  Btu/lbm·R =  $0.3704$  kPa·m<sup>3</sup>/lbm·R (Table A-2Ea).

**Analysis** We take the tank as the system, which is a control volume since mass crosses the boundary. Noting that the microscopic energies of flowing and nonflowing fluids are represented by enthalpy  $h$  and internal energy  $u$ , respectively, the mass and energy balances for this uniform-flow system can be expressed as

*Mass balance:*

$$m_{\text{in}} - m_{\text{out}} = \Delta m_{\text{system}} \rightarrow m_i = m_2$$

*Energy balance:*

$$\underbrace{E_{\text{in}} - E_{\text{out}}}_{\substack{\text{Net energy transfer} \\ \text{by heat, work, and mass}}} = \underbrace{\Delta E_{\text{system}}}_{\substack{\text{Change in internal, kinetic,} \\ \text{potential, etc. energies}}}$$

$$m_i h_i = m_2 u_2$$

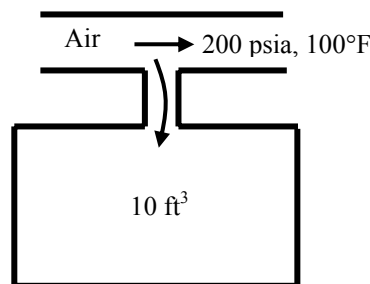

*Combining the two balances:*

$$h_i = u_2 \longrightarrow c_p T_i = c_v T_2 \longrightarrow T_2 = \frac{c_p}{c_v} T_i = k T_i$$

Substituting,

$$T_2 = k T_i = (1.4)(560 \text{ R}) = 784 \text{ R}$$

The final mass in the tank is

$$m_2 = m_i = \frac{P V}{R T_2} = \frac{(200 \text{ psia})(10 \text{ ft}^3)}{(0.3704 \text{ psia} \cdot \text{ft}^3 / \text{lbm} \cdot \text{R})(784 \text{ R})} = 6.887 \text{ lbm}$$

The work potential associated with this process is equal to the exergy destroyed during the process. The exergy destruction during a process can be determined from an exergy balance or directly from its definition  $X_{\text{destroyed}} = T_0 S_{\text{gen}}$ . The entropy generation  $S_{\text{gen}}$  in this case is determined from an entropy balance on the system:

$$\underbrace{S_{\text{in}} - S_{\text{out}}}_{\substack{\text{Net entropy transfer} \\ \text{by heat and mass}}} + \underbrace{S_{\text{gen}}}_{\substack{\text{Entropy} \\ \text{generation}}} = \underbrace{\Delta S_{\text{system}}}_{\substack{\text{Change} \\ \text{in entropy}}}$$

$$m_i s_i + S_{\text{gen}} = \Delta S_{\text{tank}} = m_2 s_2$$

$$S_{\text{gen}} = m_2 s_2 - m_i s_i$$

$$S_{\text{gen}} = m_2 (s_2 - s_i)$$

Substituting,

$$W_{\text{rev}} = X_{\text{destroyed}} = m_2 T_0 (s_2 - s_i) = m_2 T_0 \left( c_p \ln \frac{T_2}{T_1} \right)$$

$$= (6.887 \text{ lbm})(540 \text{ R}) \left[ (0.240 \text{ Btu/lbm} \cdot \text{R}) \ln \frac{784 \text{ R}}{560 \text{ R}} \right]$$

$$= \mathbf{300.3 \text{ Btu}}$$

**8-75** An rigid tank that is initially evacuated is filled by air from a supply line. The work potential associated with this process is to be determined.

**Assumptions 1** This is an unsteady process since the conditions within the device are changing during the process. It can be analyzed as a uniform-flow process since the state of fluid entering the device remains constant. **2** Kinetic and potential energies are negligible. **3** There are no work interactions involved. **4** Air is an ideal gas with constant specific heats.

**Properties** The properties of air at room temperature are  $c_p = 0.240$  Btu/lbm·R and  $R = 0.06855$  Btu/lbm·R =  $0.3704$  kPa·m<sup>3</sup>/lbm·R (Table A-2Ea).

**Analysis** We take the tank as the system, which is a control volume since mass crosses the boundary. Noting that the microscopic energies of flowing and nonflowing fluids are represented by enthalpy  $h$  and internal energy  $u$ , respectively, the mass and energy balances for this uniform-flow system can be expressed as

$$\text{Mass balance: } m_{\text{in}} - m_{\text{out}} = \Delta m_{\text{system}} \rightarrow m_i = m_2$$

**Energy balance:**

$$\underbrace{E_{\text{in}} - E_{\text{out}}}_{\substack{\text{Net energy transfer} \\ \text{by heat, work, and mass}}} = \underbrace{\Delta E_{\text{system}}}_{\substack{\text{Change in internal, kinetic,} \\ \text{potential, etc. energies}}}$$

$$m_i h_i - Q_{\text{out}} = m_2 u_2$$

$$Q_{\text{out}} = m_i h_i - m_2 u_2$$

**Combining the two balances:**

$$Q_{\text{out}} = m_2 (h_i - u_2)$$

The final mass in the tank is

$$m_2 = m_i = \frac{P V}{R T_2} = \frac{(200 \text{ psia})(10 \text{ ft}^3)}{(0.3704 \text{ psia} \cdot \text{ft}^3/\text{lbm} \cdot \text{R})(560 \text{ R})} = 9.642 \text{ lbm}$$

Substituting,

$$Q_{\text{out}} = m_2 (h_i - u_2) = m_2 (c_p T_i - c_v T_i) = m_2 T_i (c_p - c_v) = m_2 T_i R$$

$$= (9.642 \text{ lbm})(560 \text{ R})(0.06855 \text{ Btu/lbm} \cdot \text{R})$$

$$= 370.1 \text{ Btu}$$

The work potential associated with this process is equal to the exergy destroyed during the process. The exergy destruction during a process can be determined from an exergy balance or directly from its definition  $X_{\text{destroyed}} = T_0 S_{\text{gen}}$ . The entropy generation  $S_{\text{gen}}$  in this case is determined from an entropy

balance on the system:

$$\underbrace{S_{\text{in}} - S_{\text{out}}}_{\substack{\text{Net entropy transfer} \\ \text{by heat and mass}}} + \underbrace{S_{\text{gen}}}_{\substack{\text{Entropy} \\ \text{generation}}} = \underbrace{\Delta S_{\text{system}}}_{\substack{\text{Change} \\ \text{in entropy}}}$$

$$m_i s_i - \frac{Q_{\text{out}}}{T_0} + S_{\text{gen}} = \Delta S_{\text{tank}} = m_2 s_2$$

$$S_{\text{gen}} = m_2 s_2 - m_i s_i + \frac{Q_{\text{out}}}{T_0}$$

$$S_{\text{gen}} = m_2 (s_2 - s_i) + \frac{Q_{\text{out}}}{T_0}$$

Noting that both the temperature and pressure in the tank is same as those in the supply line at the final state, substituting gives,

$$W_{\text{rev}} = X_{\text{destroyed}} = T_0 \left[ m_2 (s_2 - s_i) + \frac{Q_{\text{out}}}{T_0} \right]$$

$$= T_0 \left( 0 + \frac{Q_{\text{out}}}{T_0} \right) = T_0 \left( \frac{Q_{\text{out}}}{T_0} \right) = Q_{\text{out}} = \mathbf{370.1 \text{ Btu}}$$

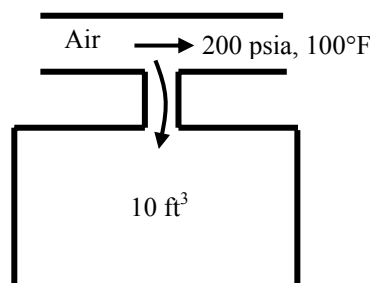

**8-76** Steam expands in a turbine steadily at a specified rate from a specified state to another specified state. The power potential of the steam at the inlet conditions and the reversible power output are to be determined.

**Assumptions 1** This is a steady-flow process since there is no change with time. **2** Kinetic and potential energy changes are negligible. **3** The temperature of the surroundings is given to be 25°C.

**Properties** From the steam tables (Tables A-4 through 6)

$$\left. \begin{array}{l} P_1 = 8 \text{ MPa} \\ T_1 = 450^\circ\text{C} \end{array} \right\} \begin{array}{l} h_1 = 3273.3 \text{ kJ/kg} \\ s_1 = 6.5579 \text{ kJ/kg} \cdot \text{K} \end{array}$$

$$\left. \begin{array}{l} P_2 = 50 \text{ kPa} \\ \text{sat. vapor} \end{array} \right\} \begin{array}{l} h_2 = 2645.2 \text{ kJ/kg} \\ s_2 = 7.5931 \text{ kJ/kg} \cdot \text{K} \end{array}$$

$$\left. \begin{array}{l} P_0 = 100 \text{ kPa} \\ T_0 = 25^\circ\text{C} \end{array} \right\} \begin{array}{l} h_0 \cong h_f @ 25^\circ\text{C} = 104.83 \text{ kJ/kg} \\ s_0 \cong s_f @ 25^\circ\text{C} = 0.36723 \text{ kJ/kg} \cdot \text{K} \end{array}$$

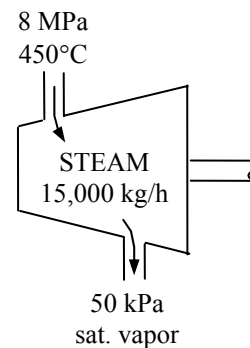

**Analysis (a)** The power potential of the steam at the inlet conditions is equivalent to its exergy at the inlet state,

$$\begin{aligned} \dot{\Psi} &= \dot{m} \psi_1 = \dot{m} \left( h_1 - h_0 - T_0 (s_1 - s_0) + \frac{V_1^2}{2} + gz_1 \right) = \dot{m} (h_1 - h_0 - T_0 (s_1 - s_0)) \\ &= (15,000 / 3600 \text{ kg/s}) [(3273.3 - 104.83) \text{ kJ/kg} - (298 \text{ K})(6.5579 - 0.36723) \text{ kJ/kg} \cdot \text{K}] \\ &= \mathbf{5515 \text{ kW}} \end{aligned}$$

**(b)** The power output of the turbine if there were no irreversibilities is the reversible power, is determined from the rate form of the exergy balance applied on the turbine and setting the exergy destruction term equal to zero,

$$\underbrace{\dot{X}_{\text{in}} - \dot{X}_{\text{out}}}_{\text{Rate of net exergy transfer by heat, work, and mass}} - \underbrace{\dot{X}_{\text{destroyed}}}_{\text{Rate of exergy destruction}} \stackrel{\text{reversible}}{=} \underbrace{\Delta \dot{X}_{\text{system}}}_{\text{Rate of change of exergy}} \stackrel{\text{steady}}{=} 0$$

$$\dot{X}_{\text{in}} = \dot{X}_{\text{out}}$$

$$\dot{m} \psi_1 = \dot{W}_{\text{rev, out}} + \dot{m} \psi_2$$

$$\dot{W}_{\text{rev, out}} = \dot{m} (\psi_1 - \psi_2) = \dot{m} [(h_1 - h_2) - T_0 (s_1 - s_2) - \Delta ke^{\text{rev}} - \Delta pe^{\text{rev}}]$$

Substituting,

$$\begin{aligned} \dot{W}_{\text{rev, out}} &= \dot{m} [(h_1 - h_2) - T_0 (s_1 - s_2)] \\ &= (15,000 / 3600 \text{ kg/s}) [(3273.3 - 2645.2) \text{ kJ/kg} - (298 \text{ K})(6.5579 - 7.5931) \text{ kJ/kg} \cdot \text{K}] \\ &= \mathbf{3902 \text{ kW}} \end{aligned}$$

**8-77E** Air is compressed steadily by a 400-hp compressor from a specified state to another specified state while being cooled by the ambient air. The mass flow rate of air and the part of input power that is used to just overcome the irreversibilities are to be determined.

**Assumptions 1** Air is an ideal gas with variable specific heats. **2** Potential energy changes are negligible. **3** The temperature of the surroundings is given to be 60°F.

**Properties** The gas constant of air is  $R = 0.06855$  Btu/lbm·R (Table A-1E). From the air table (Table A-17E)

$$\begin{aligned} T_1 = 520 \text{ R} & \left\{ \begin{array}{l} h_1 = 124.27 \text{ Btu/lbm} \\ s_1^0 = 0.59173 \text{ Btu/lbm} \cdot \text{R} \end{array} \right. \\ P_1 = 15 \text{ psia} & \\ T_2 = 1080 \text{ R} & \left\{ \begin{array}{l} h_2 = 260.97 \text{ Btu/lbm} \\ s_2^0 = 0.76964 \text{ Btu/lbm} \cdot \text{R} \end{array} \right. \\ P_2 = 150 \text{ psia} & \end{aligned}$$

**Analysis (a)** There is only one inlet and one exit, and thus  $\dot{m}_1 = \dot{m}_2 = \dot{m}$ . We take the actual compressor as the system, which is a control volume. The energy balance for this steady-flow system can be expressed as

$$\underbrace{\dot{E}_{\text{in}} - \dot{E}_{\text{out}}}_{\text{Rate of net energy transfer by heat, work, and mass}} = \underbrace{\Delta \dot{E}_{\text{system}}^{\text{70 (steady)}}}_{\text{Rate of change in internal, kinetic, potential, etc. energies}} = 0$$

$$\dot{E}_{\text{in}} = \dot{E}_{\text{out}}$$

$$\dot{W}_{a,\text{in}} + \dot{m}(h_1 + V_1^2/2) = \dot{m}(h_2 + V_2^2/2) + \dot{Q}_{\text{out}} \rightarrow \dot{W}_{a,\text{in}} - \dot{Q}_{\text{out}} = \dot{m} \left( h_2 - h_1 + \frac{V_2^2 - V_1^2}{2} \right)$$

Substituting, the mass flow rate of the refrigerant becomes

$$(400 \text{ hp}) \left( \frac{0.7068 \text{ Btu/s}}{1 \text{ hp}} \right) - (1500/60 \text{ Btu/s}) = \dot{m} \left( 260.97 - 124.27 + \frac{(350 \text{ ft/s})^2 - 0}{2} \frac{1 \text{ Btu/lbm}}{25,037 \text{ ft}^2/\text{s}^2} \right)$$

It yields  $\dot{m} = 1.852 \text{ lbm/s}$

(b) The portion of the power output that is used just to overcome the irreversibilities is equivalent to exergy destruction, which can be determined from an exergy balance or directly from its definition

$\dot{X}_{\text{destroyed}} = T_0 \dot{S}_{\text{gen}}$  where the entropy generation  $\dot{S}_{\text{gen}}$  is determined from an entropy balance on an extended system that includes the device and its immediate surroundings. It gives

$$\underbrace{\dot{S}_{\text{in}} - \dot{S}_{\text{out}}}_{\text{Rate of net entropy transfer by heat and mass}} + \underbrace{\dot{S}_{\text{gen}}}_{\text{Rate of entropy generation}} = \underbrace{\Delta \dot{S}_{\text{system}}^{\text{70}}}_{\text{Rate of change of entropy}} = 0$$

$$\dot{m}s_1 - \dot{m}s_2 - \frac{\dot{Q}_{\text{out}}}{T_{b,\text{surr}}} + \dot{S}_{\text{gen}} = 0 \rightarrow \dot{S}_{\text{gen}} = \dot{m}(s_2 - s_1) + \frac{\dot{Q}_{\text{out}}}{T_0}$$

where

$$\begin{aligned} s_2 - s_1 &= s_2^0 - s_1^0 - R \ln \frac{P_2}{P_1} = (0.76964 - 0.59173) \text{ Btu/lbm} - (0.06855 \text{ Btu/lbm} \cdot \text{R}) \ln \frac{150 \text{ psia}}{15 \text{ psia}} \\ &= 0.02007 \text{ Btu/lbm} \cdot \text{R} \end{aligned}$$

Substituting, the exergy destruction is determined to be

$$\begin{aligned} \dot{X}_{\text{destroyed}} &= T_0 \dot{S}_{\text{gen}} = T_0 \left( \dot{m}(s_2 - s_1) + \frac{\dot{Q}_{\text{out}}}{T_0} \right) \\ &= (520 \text{ R}) \left( (1.852 \text{ lbm/s})(0.02007 \text{ Btu/lbm} \cdot \text{R}) + \frac{1500/60 \text{ Btu/s}}{520 \text{ R}} \right) \left( \frac{1 \text{ hp}}{0.7068 \text{ Btu/s}} \right) = 62.72 \text{ hp} \end{aligned}$$

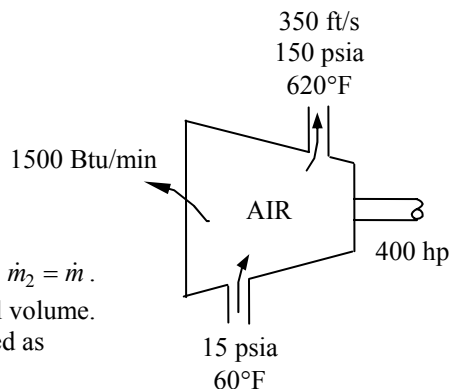

**8-78** Hot combustion gases are accelerated in an adiabatic nozzle. The exit velocity and the decrease in the exergy of the gases are to be determined.

**Assumptions 1** This is a steady-flow process since there is no change with time. **2** Potential energy changes are negligible. **3** The device is adiabatic and thus heat transfer is negligible. **4** The combustion gases are ideal gases with constant specific heats.

**Properties** The constant pressure specific heat and the specific heat ratio are given to be  $c_p = 1.15 \text{ kJ/kg}\cdot\text{K}$  and  $k = 1.3$ . The gas constant  $R$  is determined from

$$R = c_p - c_v = c_p - c_p / k = c_p (1 - 1/k) = (1.15 \text{ kJ/kg}\cdot\text{K})(1 - 1/1.3) = 0.2654 \text{ kJ/kg}\cdot\text{K}$$

**Analysis (a)** There is only one inlet and one exit, and thus  $\dot{m}_1 = \dot{m}_2 = \dot{m}$ . We take the nozzle as the system, which is a control volume. The energy balance for this steady-flow system can be expressed as

$$\underbrace{\dot{E}_{\text{in}} - \dot{E}_{\text{out}}}_{\text{Rate of net energy transfer by heat, work, and mass}} = \underbrace{\Delta \dot{E}_{\text{system}}^{\text{no}}}_{\text{Rate of change in internal, kinetic, potential, etc. energies (steady)}} = 0$$

$$\dot{E}_{\text{in}} = \dot{E}_{\text{out}}$$

$$\dot{m}(h_1 + V_1^2/2) = \dot{m}(h_2 + V_2^2/2) \quad (\text{since } \dot{W} = \dot{Q} \cong \Delta \text{pe} \cong 0)$$

$$h_2 = h_1 - \frac{V_2^2 - V_1^2}{2}$$

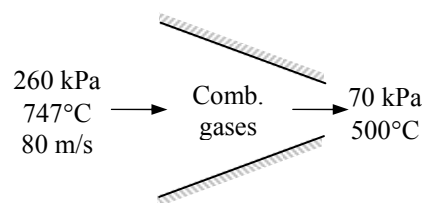

Then the exit velocity becomes

$$\begin{aligned} V_2 &= \sqrt{2c_p(T_1 - T_2) + V_1^2} \\ &= \sqrt{2(1.15 \text{ kJ/kg}\cdot\text{K})(747 - 500)\text{K} \left( \frac{1000 \text{ m}^2/\text{s}^2}{1 \text{ kJ/kg}} \right) + (80 \text{ m/s})^2} \\ &= \mathbf{758 \text{ m/s}} \end{aligned}$$

(b) The decrease in exergy of combustion gases is simply the difference between the initial and final values of flow exergy, and is determined to be

$$\psi_1 - \psi_2 = w_{\text{rev}} = h_1 - h_2 - \Delta \text{ke} - \Delta \text{pe}^{\text{no}} + T_0(s_2 - s_1) = c_p(T_1 - T_2) + T_0(s_2 - s_1) - \Delta \text{ke}$$

where

$$\Delta \text{ke} = \frac{V_2^2 - V_1^2}{2} = \frac{(758 \text{ m/s})^2 - (80 \text{ m/s})^2}{2} \left( \frac{1 \text{ kJ/kg}}{1000 \text{ m}^2/\text{s}^2} \right) = 284.1 \text{ kJ/kg}$$

and

$$\begin{aligned} s_2 - s_1 &= c_p \ln \frac{T_2}{T_1} - R \ln \frac{P_2}{P_1} \\ &= (1.15 \text{ kJ/kg}\cdot\text{K}) \ln \frac{773 \text{ K}}{1020 \text{ K}} - (0.2654 \text{ kJ/kg}\cdot\text{K}) \ln \frac{70 \text{ kPa}}{260 \text{ kPa}} \\ &= 0.02938 \text{ kJ/kg}\cdot\text{K} \end{aligned}$$

Substituting,

$$\begin{aligned} \text{Decrease in exergy} &= \psi_1 - \psi_2 \\ &= (1.15 \text{ kJ/kg}\cdot\text{K})(747 - 500)^\circ\text{C} + (293 \text{ K})(0.02938 \text{ kJ/kg}\cdot\text{K}) - 284.1 \text{ kJ/kg} \\ &= \mathbf{8.56 \text{ kJ/kg}} \end{aligned}$$

**8-79** Steam is accelerated in an adiabatic nozzle. The exit velocity of the steam, the isentropic efficiency, and the exergy destroyed within the nozzle are to be determined.

**Assumptions** 1 The nozzle operates steadily. 2 The changes in potential energies are negligible.

**Properties** The properties of steam at the inlet and the exit of the nozzle are (Tables A-4 through A-6)

$$\left. \begin{aligned} P_1 &= 7 \text{ MPa} \\ T_1 &= 500^\circ\text{C} \end{aligned} \right\} \begin{aligned} h_1 &= 3411.4 \text{ kJ/kg} \\ s_1 &= 6.8000 \text{ kJ/kg} \cdot \text{K} \end{aligned}$$

$$\left. \begin{aligned} P_2 &= 5 \text{ MPa} \\ T_2 &= 450^\circ\text{C} \end{aligned} \right\} \begin{aligned} h_2 &= 3317.2 \text{ kJ/kg} \\ s_2 &= 6.8210 \text{ kJ/kg} \cdot \text{K} \end{aligned}$$

$$\left. \begin{aligned} P_{2s} &= 5 \text{ MPa} \\ s_{2s} &= s_1 \end{aligned} \right\} h_{2s} = 3302.0 \text{ kJ/kg}$$

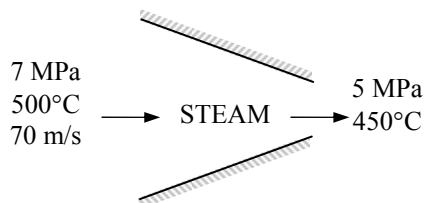

**Analysis** (a) We take the nozzle to be the system, which is a control volume. The energy balance for this steady-flow system can be expressed in the rate form as

$$\underbrace{\dot{E}_{\text{in}} - \dot{E}_{\text{out}}}_{\text{Rate of net energy transfer by heat, work, and mass}} = \underbrace{\Delta \dot{E}_{\text{system}}^{\neq 0} (\text{steady})}_{\text{Rate of change in internal, kinetic, potential, etc. energies}} = 0$$

$$\dot{E}_{\text{in}} = \dot{E}_{\text{out}}$$

$$\dot{m}(h_1 + V_1^2/2) = \dot{m}(h_2 + V_2^2/2) \quad (\text{since } \dot{W} = \dot{Q} \cong \Delta p_e \cong 0)$$

$$0 = h_2 - h_1 + \frac{V_2^2 - V_1^2}{2}$$

Then the exit velocity becomes

$$V_2 = \sqrt{2(h_1 - h_2) + V_1^2} = \sqrt{2(3411.4 - 3317.2) \text{ kJ/kg} \left( \frac{1000 \text{ m}^2/\text{s}^2}{1 \text{ kJ/kg}} \right) + (70 \text{ m/s})^2} = \mathbf{439.6 \text{ m/s}}$$

(b) The exit velocity for the isentropic case is determined from

$$V_{2s} = \sqrt{2(h_1 - h_{2s}) + V_1^2} = \sqrt{2(3411.4 - 3302.0) \text{ kJ/kg} \left( \frac{1000 \text{ m}^2/\text{s}^2}{1 \text{ kJ/kg}} \right) + (70 \text{ m/s})^2} = 472.9 \text{ m/s}$$

Thus,

$$\eta_N = \frac{V_2^2/2}{V_{2s}^2/2} = \frac{(439.6 \text{ m/s})^2/2}{(472.9 \text{ m/s})^2/2} = \mathbf{86.4\%}$$

(c) The exergy destroyed during a process can be determined from an exergy balance or directly from its definition  $X_{\text{destroyed}} = T_0 S_{\text{gen}}$  where the entropy generation  $S_{\text{gen}}$  is determined from an entropy balance on the actual nozzle. It gives

$$\underbrace{\dot{S}_{\text{in}} - \dot{S}_{\text{out}}}_{\text{Rate of net entropy transfer by heat and mass}} + \underbrace{\dot{S}_{\text{gen}}}_{\text{Rate of entropy generation}} = \underbrace{\Delta \dot{S}_{\text{system}}^{\neq 0}}_{\text{Rate of change of entropy}} = 0$$

$$\dot{m}s_1 - \dot{m}s_2 + \dot{S}_{\text{gen}} = 0 \rightarrow \dot{S}_{\text{gen}} = \dot{m}(s_2 - s_1) \quad \text{or} \quad s_{\text{gen}} = s_2 - s_1$$

Substituting, the exergy destruction in the nozzle on a unit mass basis is determined to be

$$x_{\text{destroyed}} = T_0 s_{\text{gen}} = T_0 (s_2 - s_1) = (298 \text{ K})(6.8210 - 6.8000) \text{ kJ/kg} \cdot \text{K} = \mathbf{6.28 \text{ kJ/kg}}$$



**8-80** CO<sub>2</sub> gas is compressed steadily by a compressor from a specified state to another specified state. The power input to the compressor if the process involved no irreversibilities is to be determined.

**Assumptions 1** This is a steady-flow process since there is no change with time. **2** Kinetic and potential energy changes are negligible. **3** The device is adiabatic and thus heat transfer is negligible. **4** CO<sub>2</sub> is an ideal gas with constant specific heats.

**Properties** At the average temperature of  $(300 + 450)/2 = 375$  K, the constant pressure specific heat and the specific heat ratio of CO<sub>2</sub> are  $k = 1.261$  and  $c_p = 0.917$  kJ/kg·K (Table A-2).

**Analysis** The reversible (or minimum) power input is determined from the exergy balance applied on the compressor, and setting the exergy destruction term equal to zero,

$$\underbrace{\dot{X}_{\text{in}} - \dot{X}_{\text{out}}}_{\text{Rate of net exergy transfer by heat, work, and mass}} - \underbrace{\dot{X}_{\text{destroyed}}}_{\text{Rate of exergy destruction}} \stackrel{\approx 0 \text{ (reversible)}}{=} \underbrace{\Delta \dot{X}_{\text{system}}}_{\text{Rate of change of exergy}} \stackrel{\approx 0 \text{ (steady)}}{=} 0$$

$$\begin{aligned} \dot{X}_{\text{in}} &= \dot{X}_{\text{out}} \\ \dot{m}\psi_1 + \dot{W}_{\text{rev,in}} &= \dot{m}\psi_2 \\ \dot{W}_{\text{rev,in}} &= \dot{m}(\psi_2 - \psi_1) \\ &= \dot{m}[(h_2 - h_1) - T_0(s_2 - s_1) + \Delta ke^{\approx 0} + \Delta pe^{\approx 0}] \end{aligned}$$

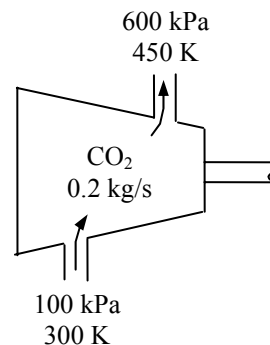

where

$$\begin{aligned} s_2 - s_1 &= c_p \ln \frac{T_2}{T_1} - R \ln \frac{P_2}{P_1} \\ &= (0.9175 \text{ kJ/kg} \cdot \text{K}) \ln \frac{450 \text{ K}}{300 \text{ K}} - (0.1889 \text{ kJ/kg} \cdot \text{K}) \ln \frac{600 \text{ kPa}}{100 \text{ kPa}} \\ &= 0.03335 \text{ kJ/kg} \cdot \text{K} \end{aligned}$$

Substituting,

$$\dot{W}_{\text{rev,in}} = (0.2 \text{ kg/s})[(0.917 \text{ kJ/kg} \cdot \text{K})(450 - 300)\text{K} - (298 \text{ K})(0.03335 \text{ kJ/kg} \cdot \text{K})] = \mathbf{25.5 \text{ kW}}$$

**Discussion** Note that a minimum of 25.5 kW of power input is needed for this compressor.

**8-81** Liquid water is heated in a chamber by mixing it with superheated steam. For a specified mixing temperature, the mass flow rate of the steam and the rate of exergy destruction are to be determined.

**Assumptions** **1** This is a steady-flow process since there is no change with time. **2** Kinetic and potential energy changes are negligible. **3** There are no work interactions.

**Properties** Noting that  $T < T_{\text{sat}@200 \text{ kPa}} = 120.23^\circ\text{C}$ , the cold water and the exit mixture streams exist as a compressed liquid, which can be approximated as a saturated liquid at the given temperature. From Tables A-4 through A-6,

$$\left. \begin{array}{l} P_1 = 200 \text{ kPa} \\ T_1 = 20^\circ\text{C} \end{array} \right\} \begin{array}{l} h_1 \cong h_{f@20^\circ\text{C}} = 83.91 \text{ kJ/kg} \\ s_1 \cong s_{f@20^\circ\text{C}} = 0.29649 \text{ kJ/kg} \cdot \text{K} \end{array}$$

$$\left. \begin{array}{l} P_2 = 200 \text{ kPa} \\ T_2 = 300^\circ\text{C} \end{array} \right\} \begin{array}{l} h_2 = 3072.1 \text{ kJ/kg} \\ s_2 = 7.8941 \text{ kJ/kg} \cdot \text{K} \end{array}$$

$$\left. \begin{array}{l} P_3 = 200 \text{ kPa} \\ T_3 = 60^\circ\text{C} \end{array} \right\} \begin{array}{l} h_3 \cong h_{f@60^\circ\text{C}} = 251.18 \text{ kJ/kg} \\ s_3 \cong s_{f@60^\circ\text{C}} = 0.83130 \text{ kJ/kg} \cdot \text{K} \end{array}$$

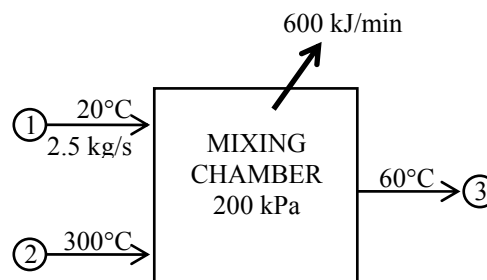

**Analysis** (a) We take the mixing chamber as the system, which is a control volume. The mass and energy balances for this steady-flow system can be expressed in the rate form as

$$\text{Mass balance: } \dot{m}_{\text{in}} - \dot{m}_{\text{out}} = \Delta \dot{m}_{\text{system}} \stackrel{\approx 0 \text{ (steady)}}{=} 0 \longrightarrow \dot{m}_1 + \dot{m}_2 = \dot{m}_3$$

Energy balance:

$$\underbrace{\dot{E}_{\text{in}} - \dot{E}_{\text{out}}}_{\text{Rate of net energy transfer by heat, work, and mass}} = \underbrace{\Delta \dot{E}_{\text{system}}}_{\text{Rate of change in internal, kinetic, potential, etc. energies}} \stackrel{\approx 0 \text{ (steady)}}{=} 0$$

$$\dot{E}_{\text{in}} = \dot{E}_{\text{out}}$$

$$\dot{m}h_1 + \dot{m}_2h_2 = \dot{Q}_{\text{out}} + \dot{m}_3h_3$$

Combining the two relations gives  $\dot{Q}_{\text{out}} = \dot{m}_1h_1 + \dot{m}_2h_2 - (\dot{m}_1 + \dot{m}_2)h_3 = \dot{m}_1(h_1 - h_3) + \dot{m}_2(h_2 - h_3)$

Solving for  $\dot{m}_2$  and substituting, the mass flow rate of the superheated steam is determined to be

$$\dot{m}_2 = \frac{\dot{Q}_{\text{out}} - \dot{m}_1(h_1 - h_3)}{h_2 - h_3} = \frac{(600/60 \text{ kJ/s}) - (2.5 \text{ kg/s})(83.91 - 251.18) \text{ kJ/kg}}{(3072.1 - 251.18) \text{ kJ/kg}} = \mathbf{0.148 \text{ kg/s}}$$

Also,  $\dot{m}_3 = \dot{m}_1 + \dot{m}_2 = 2.5 + 0.148 = 2.648 \text{ kg/s}$

(b) The exergy destroyed during a process can be determined from an exergy balance or directly from its definition  $X_{\text{destroyed}} = T_0 S_{\text{gen}}$  where the entropy generation  $S_{\text{gen}}$  is determined from an entropy balance on an *extended system* that includes the mixing chamber and its immediate surroundings. It gives

$$\underbrace{\dot{S}_{\text{in}} - \dot{S}_{\text{out}}}_{\text{Rate of net entropy transfer by heat and mass}} + \underbrace{\dot{S}_{\text{gen}}}_{\text{Rate of entropy generation}} = \underbrace{\Delta \dot{S}_{\text{system}}}_{\text{Rate of change of entropy}} \stackrel{\approx 0}{=} 0$$

$$\dot{m}_1s_1 + \dot{m}_2s_2 - \dot{m}_3s_3 - \frac{\dot{Q}_{\text{out}}}{T_{b,\text{surr}}} + \dot{S}_{\text{gen}} = 0 \rightarrow \dot{S}_{\text{gen}} = \dot{m}_3s_3 - \dot{m}_1s_1 - \dot{m}_2s_2 + \frac{\dot{Q}_{\text{out}}}{T_0}$$

Substituting, the exergy destruction is determined to be

$$\begin{aligned} \dot{X}_{\text{destroyed}} &= T_0 \dot{S}_{\text{gen}} = T_0 \left( \dot{m}_3s_3 - \dot{m}_2s_2 - \dot{m}_1s_1 + \frac{\dot{Q}_{\text{out}}}{T_{b,\text{surr}}} \right) \\ &= (298 \text{ K})(2.648 \times 0.83130 - 0.148 \times 7.8941 - 2.5 \times 0.29649 + 10 / 298) \text{ kW/K} = \mathbf{96.4 \text{ kW}} \end{aligned}$$

**8-82** A rigid tank initially contains saturated R-134a vapor. The tank is connected to a supply line, and R-134a is allowed to enter the tank. The mass of the R-134a that entered the tank and the exergy destroyed during this process are to be determined.

**Assumptions 1** This is an unsteady process since the conditions within the device are changing during the process, but it can be analyzed as a uniform-flow process since the state of fluid at the inlet remains constant. **2** Kinetic and potential energies are negligible. **3** There are no work interactions involved. **4** The direction of heat transfer is to the tank (will be verified).

**Properties** The properties of refrigerant are (Tables A-11 through A-13)

$$P_1 = 1.2 \text{ MPa} \left\{ \begin{array}{l} \nu_1 = \nu_{g@1.2 \text{ MPa}} = 0.01672 \text{ m}^3 / \text{kg} \\ u_1 = u_{g@1.2 \text{ MPa}} = 253.81 \text{ kJ/kg} \\ s_1 = s_{g@1.2 \text{ MPa}} = 0.91303 \text{ kJ/kg} \cdot \text{K} \end{array} \right.$$

$$T_2 = 1.4 \text{ MPa} \left\{ \begin{array}{l} \nu_2 = \nu_{f@1.4 \text{ MPa}} = 0.0009166 \text{ m}^3 / \text{kg} \\ u_2 = u_{f@1.4 \text{ MPa}} = 125.94 \text{ kJ/kg} \\ s_2 = s_{f@1.4 \text{ MPa}} = 0.45315 \text{ kJ/kg} \cdot \text{K} \end{array} \right.$$

$$\left. \begin{array}{l} P_i = 1.6 \text{ MPa} \\ T_i = 30^\circ\text{C} \end{array} \right\} \begin{array}{l} h_i = 93.56 \text{ kJ/kg} \\ s_i = 0.34554 \text{ kJ/kg} \cdot \text{K} \end{array}$$

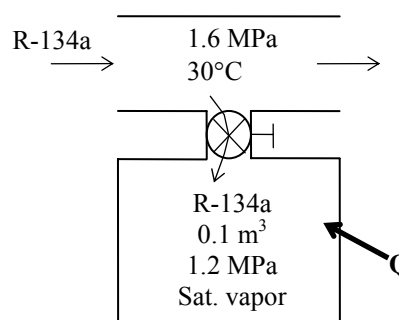

**Analysis** We take the tank as the system, which is a control volume. Noting that the microscopic energies of flowing and nonflowing fluids are represented by enthalpy  $h$  and internal energy  $u$ , respectively, the mass and energy balances for this uniform-flow system can be expressed as

*Mass balance:*

$$m_{\text{in}} - m_{\text{out}} = \Delta m_{\text{system}} \rightarrow m_i = m_2 - m_1$$

*Energy balance:*

$$\underbrace{E_{\text{in}} - E_{\text{out}}}_{\substack{\text{Net energy transfer} \\ \text{by heat, work, and mass}}} = \underbrace{\Delta E_{\text{system}}}_{\substack{\text{Change in internal, kinetic,} \\ \text{potential, etc. energies}}}$$

$$Q_{\text{in}} + m_i h_i = m_2 u_2 - m_1 u_1 \quad (\text{since } W \cong \text{ke} \cong \text{pe} \cong 0)$$

(a) The initial and the final masses in the tank are

$$m_1 = \frac{\nu_1}{\nu_1} = \frac{0.1 \text{ m}^3}{0.01672 \text{ m}^3/\text{kg}} = 5.983 \text{ kg}$$

$$m_2 = \frac{\nu_2}{\nu_2} = \frac{0.1 \text{ m}^3}{0.0009166 \text{ m}^3/\text{kg}} = 109.10 \text{ kg}$$

Then from the mass balance

$$m_i = m_2 - m_1 = 109.10 - 5.983 = \mathbf{103.11 \text{ kg}}$$

The heat transfer during this process is determined from the energy balance to be

$$\begin{aligned} Q_{\text{in}} &= -m_i h_i + m_2 u_2 - m_1 u_1 \\ &= -(103.11 \text{ kg})(93.56 \text{ kJ/kg}) + (109.10)(125.94 \text{ kJ/kg}) - (5.983 \text{ kg})(253.81 \text{ kJ/kg}) \\ &= 2573 \text{ kJ} \end{aligned}$$

(b) The exergy destroyed during a process can be determined from an exergy balance or directly from its definition  $X_{\text{destroyed}} = T_0 S_{\text{gen}}$ . The entropy generation  $S_{\text{gen}}$  in this case is determined from an entropy balance on an *extended system* that includes the tank and its immediate surroundings so that the boundary temperature of the extended system is the surroundings temperature  $T_{\text{surr}}$  at all times. It gives

$$\underbrace{S_{\text{in}} - S_{\text{out}}}_{\substack{\text{Net entropy transfer} \\ \text{by heat and mass}}} + \underbrace{S_{\text{gen}}}_{\substack{\text{Entropy} \\ \text{generation}}} = \underbrace{\Delta S_{\text{system}}}_{\substack{\text{Change} \\ \text{in entropy}}}$$

$$\frac{Q_{\text{in}}}{T_{\text{b,in}}} + m_i s_i + S_{\text{gen}} = \Delta S_{\text{tank}} = (m_2 s_2 - m_1 s_1)_{\text{tank}} \quad \text{Substituting, the}$$

$$S_{\text{gen}} = m_2 s_2 - m_1 s_1 - m_i s_i - \frac{Q_{\text{in}}}{T_0}$$

exergy destruction is determined to be

$$X_{\text{destroyed}} = T_0 S_{\text{gen}} = T_0 \left[ m_2 s_2 - m_1 s_1 - m_i s_i - \frac{Q_{\text{in}}}{T_0} \right]$$

$$= (318 \text{ K}) [109.10 \times 0.45315 - 5.983 \times 0.91303 - 103.11 \times 0.34554 - (2573 \text{ kJ}) / (318 \text{ K})]$$

$$= \mathbf{80.3 \text{ kJ}}$$

**8-83** A rigid tank initially contains saturated liquid water. A valve at the bottom of the tank is opened, and half of mass in liquid form is withdrawn from the tank. The temperature in the tank is maintained constant. The amount of heat transfer, the reversible work, and the exergy destruction during this process are to be determined.

**Assumptions 1** This is an unsteady process since the conditions within the device are changing during the process, but it can be analyzed as a uniform-flow process since the state of fluid leaving the device remains constant. **2** Kinetic and potential energies are negligible. **3** There are no work interactions involved. **4** The direction of heat transfer is to the tank (will be verified).

**Properties** The properties of water are (Tables A-4 through A-6)

$$T_1 = 170^\circ\text{C} \left\{ \begin{array}{l} \nu_1 = \nu_{f@170^\circ\text{C}} = 0.001114 \text{ m}^3/\text{kg} \\ u_1 = u_{f@170^\circ\text{C}} = 718.20 \text{ kJ/kg} \\ s_1 = s_{f@170^\circ\text{C}} = 2.0417 \text{ kJ/kg}\cdot\text{K} \end{array} \right.$$

sat. liquid

$$T_e = 170^\circ\text{C} \left\{ \begin{array}{l} h_e = h_{f@170^\circ\text{C}} = 719.08 \text{ kJ/kg} \\ s_e = s_{f@170^\circ\text{C}} = 2.0417 \text{ kJ/kg}\cdot\text{K} \end{array} \right.$$

sat. liquid

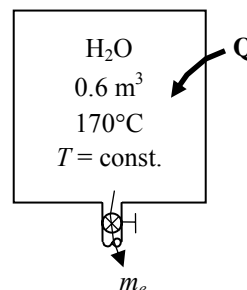

**Analysis** We take the tank as the system, which is a control volume since mass crosses the boundary. Noting that the microscopic energies of flowing and nonflowing fluids are represented by enthalpy  $h$  and internal energy  $u$ , respectively, the mass and energy balances for this uniform-flow system can be expressed as

*Mass balance:*

$$m_{\text{in}} - m_{\text{out}} = \Delta m_{\text{system}} \rightarrow m_e = m_1 - m_2$$

*Energy balance:*

$$\underbrace{E_{\text{in}} - E_{\text{out}}}_{\substack{\text{Net energy transfer} \\ \text{by heat, work, and mass}}} = \underbrace{\Delta E_{\text{system}}}_{\substack{\text{Change in internal, kinetic,} \\ \text{potential, etc. energies}}}$$

$$Q_{\text{in}} = m_e h_e + m_2 u_2 - m_1 u_1 \quad (\text{since } W \cong \text{ke} \cong \text{pe} \cong 0)$$

The initial and the final masses in the tank are

$$m_1 = \frac{\nu}{\nu_1} = \frac{0.6 \text{ m}^3}{0.001114 \text{ m}^3/\text{kg}} = 538.47 \text{ kg}$$

$$m_2 = \frac{1}{2} m_1 = \frac{1}{2} (538.47 \text{ kg}) = 269.24 \text{ kg} = m_e$$

Now we determine the final internal energy and entropy,

$$\nu_2 = \frac{\nu}{m_2} = \frac{0.6 \text{ m}^3}{269.24 \text{ kg}} = 0.002229 \text{ m}^3/\text{kg}$$

$$x_2 = \frac{\nu_2 - \nu_f}{\nu_{fg}} = \frac{0.002229 - 0.001114}{0.24260 - 0.001114} = 0.004614$$

$$T_2 = 170^\circ\text{C} \left\{ \begin{array}{l} u_2 = u_f + x_2 u_{fg} = 718.20 + (0.004614)(1857.5) = 726.77 \text{ kJ/kg} \\ s_2 = s_f + x_2 s_{fg} = 2.0417 + (0.004614)(4.6233) = 2.0630 \text{ kJ/kg}\cdot\text{K} \end{array} \right.$$

The heat transfer during this process is determined by substituting these values into the energy balance equation,

$$\begin{aligned}
 Q_{\text{in}} &= m_e h_e + m_2 u_2 - m_1 u_1 \\
 &= (269.24 \text{ kg})(719.08 \text{ kJ/kg}) + (269.24 \text{ kg})(726.77 \text{ kJ/kg}) - (538.47 \text{ kg})(718.20 \text{ kJ/kg}) \\
 &= \mathbf{2545 \text{ kJ}}
 \end{aligned}$$

(b) The exergy destroyed during a process can be determined from an exergy balance or directly from its definition  $X_{\text{destroyed}} = T_0 S_{\text{gen}}$ . The entropy generation  $S_{\text{gen}}$  in this case is determined from an entropy balance on an *extended system* that includes the tank and the region between the tank and the source so that the boundary temperature of the extended system at the location of heat transfer is the source temperature  $T_{\text{source}}$  at all times. It gives

$$\begin{aligned}
 \underbrace{S_{\text{in}} - S_{\text{out}}}_{\substack{\text{Net entropy transfer} \\ \text{by heat and mass}}} + \underbrace{S_{\text{gen}}}_{\substack{\text{Entropy} \\ \text{generation}}} &= \underbrace{\Delta S_{\text{system}}}_{\substack{\text{Change} \\ \text{in entropy}}} \\
 \frac{Q_{\text{in}}}{T_{\text{b,in}}} - m_e s_e + S_{\text{gen}} &= \Delta S_{\text{tank}} = (m_2 s_2 - m_1 s_1)_{\text{tank}} \\
 S_{\text{gen}} &= m_2 s_2 - m_1 s_1 + m_e s_e - \frac{Q_{\text{in}}}{T_{\text{source}}}
 \end{aligned}$$

Substituting, the exergy destruction is determined to be

$$\begin{aligned}
 X_{\text{destroyed}} &= T_0 S_{\text{gen}} = T_0 \left[ m_2 s_2 - m_1 s_1 + m_e s_e - \frac{Q_{\text{in}}}{T_{\text{source}}} \right] \\
 &= (298 \text{ K}) [269.24 \times 2.0630 - 538.47 \times 2.0417 + 269.24 \times 2.0417 - (2545 \text{ kJ}) / (523 \text{ K})] \\
 &= \mathbf{141.2 \text{ kJ}}
 \end{aligned}$$

For processes that involve no actual work, the reversible work output and exergy destruction are identical. Therefore,

$$X_{\text{destroyed}} = W_{\text{rev,out}} - W_{\text{act,out}} \rightarrow W_{\text{rev,out}} = X_{\text{destroyed}} = \mathbf{141.2 \text{ kJ}}$$

**8-84E** An insulated rigid tank equipped with an electric heater initially contains pressurized air. A valve is opened, and air is allowed to escape at constant temperature until the pressure inside drops to 30 psia. The amount of electrical work done and the exergy destroyed are to be determined.

**Assumptions 1** This is an unsteady process since the conditions within the device are changing during the process, but it can be analyzed as a uniform-flow process since the exit temperature (and enthalpy) of air remains constant. **2** Kinetic and potential energies are negligible. **3** The tank is insulated and thus heat transfer is negligible. **4** Air is an ideal gas with variable specific heats. **5** The environment temperature is given to be 70°F.

**Properties** The gas constant of air is  $R = 0.3704$  psia·ft<sup>3</sup>/lbm·R (Table A-1E). The properties of air are (Table A-17E)

$$T_e = 600 \text{ R} \longrightarrow h_e = 143.47 \text{ Btu/lbm}$$

$$T_1 = 600 \text{ R} \longrightarrow u_1 = 102.34 \text{ Btu/lbm}$$

$$T_2 = 600 \text{ R} \longrightarrow u_2 = 102.34 \text{ Btu/lbm}$$

**Analysis** We take the tank as the system, which is a control volume. Noting that the microscopic energies of flowing and nonflowing fluids are represented by enthalpy  $h$  and internal energy  $u$ , respectively, the mass and energy balances for this uniform-flow system can be expressed as

**Mass balance:**

$$m_{\text{in}} - m_{\text{out}} = \Delta m_{\text{system}} \rightarrow m_e = m_1 - m_2$$

**Energy balance:**

$$\underbrace{E_{\text{in}} - E_{\text{out}}}_{\substack{\text{Net energy transfer} \\ \text{by heat, work, and mass}}} = \underbrace{\Delta E_{\text{system}}}_{\substack{\text{Change in internal, kinetic,} \\ \text{potential, etc. energies}}}$$

$$W_{e,\text{in}} - m_e h_e = m_2 u_2 - m_1 u_1 \quad (\text{since } Q \cong ke \cong pe \cong 0)$$

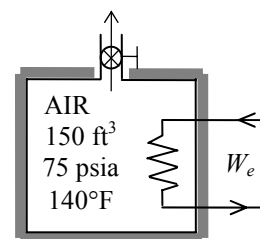

The initial and the final masses of air in the tank are

$$m_1 = \frac{P_1 \mathcal{V}}{RT_1} = \frac{(75 \text{ psia})(150 \text{ ft}^3)}{(0.3704 \text{ psia} \cdot \text{ft}^3/\text{lbm} \cdot \text{R})(600 \text{ R})} = 50.62 \text{ lbm}$$

$$m_2 = \frac{P_2 \mathcal{V}}{RT_2} = \frac{(30 \text{ psia})(150 \text{ ft}^3)}{(0.3704 \text{ psia} \cdot \text{ft}^3/\text{lbm} \cdot \text{R})(600 \text{ R})} = 20.25 \text{ lbm}$$

Then from the mass and energy balances,

$$m_e = m_1 - m_2 = 50.62 - 20.25 = 30.37 \text{ lbm}$$

$$\begin{aligned} W_{e,\text{in}} &= m_e h_e + m_2 u_2 - m_1 u_1 \\ &= (30.37 \text{ lbm})(143.47 \text{ Btu/lbm}) + (20.25 \text{ lbm})(102.34 \text{ Btu/lbm}) - (50.62 \text{ lbm})(102.34 \text{ Btu/lbm}) \\ &= \mathbf{1249 \text{ Btu}} \end{aligned}$$

(b) The exergy destroyed during a process can be determined from an exergy balance or directly from its definition  $X_{\text{destroyed}} = T_0 S_{\text{gen}}$  where the entropy generation  $S_{\text{gen}}$  is determined from an entropy balance on the insulated tank. It gives

$$\underbrace{S_{\text{in}} - S_{\text{out}}}_{\substack{\text{Net entropy transfer} \\ \text{by heat and mass}}} + \underbrace{S_{\text{gen}}}_{\substack{\text{Entropy} \\ \text{generation}}} = \underbrace{\Delta S_{\text{system}}}_{\substack{\text{Change} \\ \text{in entropy}}}$$

$$-m_e s_e + S_{\text{gen}} = \Delta S_{\text{tank}} = (m_2 s_2 - m_1 s_1)_{\text{tank}}$$

$$S_{\text{gen}} = m_2 s_2 - m_1 s_1 + m_e s_e$$

$$= m_2 s_2 - m_1 s_1 + (m_1 - m_2) s_e$$

$$= m_2 (s_2 - s_e) - m_1 (s_1 - s_e)$$

Assuming a constant average pressure of  $(75 + 30) / 2 = 52.5$  psia for the exit stream, the entropy changes are determined to be

$$s_2 - s_e = c_p \ln \frac{T_2^{\rightarrow 0}}{T_e} - R \ln \frac{P_2}{P_e} = -(0.06855 \text{ Btu/lbm} \cdot \text{R}) \ln \frac{30 \text{ psia}}{52.5 \text{ psia}} = 0.03836 \text{ Btu/lbm} \cdot \text{R}$$

$$s_1 - s_e = c_p \ln \frac{T_1^{\rightarrow 0}}{T_e} - R \ln \frac{P_1}{P_e} = -(0.06855 \text{ Btu/lbm} \cdot \text{R}) \ln \frac{75 \text{ psia}}{52.5 \text{ psia}} = -0.02445 \text{ Btu/lbm} \cdot \text{R}$$

Substituting, the exergy destruction is determined to be

$$X_{\text{destroyed}} = T_0 S_{\text{gen}} = T_0 [m_2 (s_2 - s_e) - m_1 (s_1 - s_e)]$$

$$= (530 \text{ R}) [(20.25 \text{ lbm})(0.03836 \text{ Btu/lbm} \cdot \text{R}) - (50.62 \text{ lbm})(-0.02445 \text{ Btu/lbm} \cdot \text{R})]$$

$$= \mathbf{1068 \text{ Btu}}$$



**8-85** A cylinder initially contains helium gas at a specified pressure and temperature. A valve is opened, and helium is allowed to escape until its volume decreases by half. The work potential of the helium at the initial state and the exergy destroyed during the process are to be determined.

**Assumptions 1** This is an unsteady process since the conditions within the device are changing during the process, but it can be analyzed as a uniform-flow process by using constant average properties for the helium leaving the tank. **2** Kinetic and potential energies are negligible. **3** There are no work interactions involved other than boundary work. **4** The tank is insulated and thus heat transfer is negligible. **5** Helium is an ideal gas with constant specific heats.

**Properties** The gas constant of helium is  $R = 2.0769 \text{ kPa}\cdot\text{m}^3/\text{kg}\cdot\text{K} = 2.0769 \text{ kJ}/\text{kg}\cdot\text{K}$ . The specific heats of helium are  $c_p = 5.1926 \text{ kJ}/\text{kg}\cdot\text{K}$  and  $c_v = 3.1156 \text{ kJ}/\text{kg}\cdot\text{K}$  (Table A-2).

**Analysis (a)** From the ideal gas relation, the initial and the final masses in the cylinder are determined to be

$$m_1 = \frac{P_1 V}{RT_1} = \frac{(300 \text{ kPa})(0.1 \text{ m}^3)}{(2.0769 \text{ kPa}\cdot\text{m}^3/\text{kg}\cdot\text{K})(293 \text{ K})} = 0.0493 \text{ kg}$$

$$m_e = m_2 = m_1 / 2 = 0.0493 / 2 = 0.0247 \text{ kg}$$

The work potential of helium at the initial state is simply the initial exergy of helium, and is determined from the closed-system exergy relation,

$$\Phi_1 = m_1 \phi = m_1 [(u_1 - u_0) - T_0 (s_1 - s_0) + P_0 (v_1 - v_0)]$$

where

$$v_1 = \frac{RT_1}{P_1} = \frac{(2.0769 \text{ kPa}\cdot\text{m}^3/\text{kg}\cdot\text{K})(293 \text{ K})}{300 \text{ kPa}} = 2.0284 \text{ m}^3/\text{kg}$$

$$v_0 = \frac{RT_0}{P_0} = \frac{(2.0769 \text{ kPa}\cdot\text{m}^3/\text{kg}\cdot\text{K})(293 \text{ K})}{95 \text{ kPa}} = 6.405 \text{ m}^3/\text{kg}$$

and

$$\begin{aligned} s_1 - s_0 &= c_p \ln \frac{T_1}{T_0} - R \ln \frac{P_1}{P_0} \\ &= (5.1926 \text{ kJ}/\text{kg}\cdot\text{K}) \ln \frac{293 \text{ K}}{293 \text{ K}} - (2.0769 \text{ kJ}/\text{kg}\cdot\text{K}) \ln \frac{300 \text{ kPa}}{100 \text{ kPa}} \\ &= -2.28 \text{ kJ}/\text{kg}\cdot\text{K} \end{aligned}$$

Thus,

$$\begin{aligned} \Phi_1 &= (0.0493 \text{ kg}) \{ (3.1156 \text{ kJ}/\text{kg}\cdot\text{K})(20 - 20)^\circ\text{C} - (293 \text{ K})(-2.28 \text{ kJ}/\text{kg}\cdot\text{K}) \\ &\quad + (95 \text{ kPa})(2.0284 - 6.405) \text{ m}^3/\text{kg} [\text{kJ}/\text{kPa}\cdot\text{m}^3] \} \\ &= \mathbf{12.44 \text{ kJ}} \end{aligned}$$

(b) We take the cylinder as the system, which is a control volume. Noting that the microscopic energies of flowing and nonflowing fluids are represented by enthalpy  $h$  and internal energy  $u$ , respectively, the mass and energy balances for this uniform-flow system can be expressed as

*Mass balance:*

$$m_{\text{in}} - m_{\text{out}} = \Delta m_{\text{system}} \rightarrow m_e = m_1 - m_2$$

*Energy balance:*

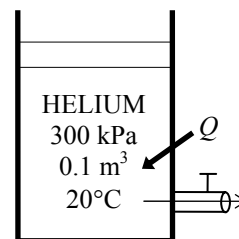

$$\underbrace{E_{\text{in}} - E_{\text{out}}}_{\substack{\text{Net energy transfer} \\ \text{by heat, work, and mass}}} = \underbrace{\Delta E_{\text{system}}}_{\substack{\text{Change in internal, kinetic,} \\ \text{potential, etc. energies}}}$$

$$Q_{\text{in}} - m_e h_e + W_{\text{b,in}} = m_2 u_2 - m_1 u_1$$

Combining the two relations gives

$$\begin{aligned} Q_{\text{in}} &= (m_1 - m_2)h_e + m_2 u_2 - m_1 u_1 - W_{\text{b,in}} \\ &= (m_1 - m_2)h_e + m_2 h_2 - m_1 h_1 \\ &= (m_1 - m_2 + m_2 - m_1)h_1 \\ &= 0 \end{aligned}$$

since the boundary work and  $\Delta U$  combine into  $\Delta H$  for constant pressure expansion and compression processes.

The exergy destroyed during a process can be determined from an exergy balance or directly from its definition  $X_{\text{destroyed}} = T_0 S_{\text{gen}}$  where the entropy generation  $S_{\text{gen}}$  can be determined from an entropy balance on the cylinder. Noting that the pressure and temperature of helium in the cylinder are maintained constant during this process and heat transfer is zero, it gives

$$\underbrace{S_{\text{in}} - S_{\text{out}}}_{\substack{\text{Net entropy transfer} \\ \text{by heat and mass}}} + \underbrace{S_{\text{gen}}}_{\substack{\text{Entropy} \\ \text{generation}}} = \underbrace{\Delta S_{\text{system}}}_{\substack{\text{Change} \\ \text{in entropy}}}$$

$$\begin{aligned} -m_e s_e + S_{\text{gen}} &= \Delta S_{\text{cylinder}} = (m_2 s_2 - m_1 s_1)_{\text{cylinder}} \\ S_{\text{gen}} &= m_2 s_2 - m_1 s_1 + m_e s_e \\ &= m_2 s_2 - m_1 s_1 + (m_1 - m_2) s_e \\ &= (m_2 - m_1 + m_1 - m_2) s_1 \\ &= 0 \end{aligned}$$

since the initial, final, and the exit states are identical and thus  $s_e = s_2 = s_1$ . Therefore, this discharge process is reversible, and

$$X_{\text{destroyed}} = T_0 S_{\text{gen}} = \mathbf{0}$$

**8-86** A rigid tank initially contains saturated R-134a vapor at a specified pressure. The tank is connected to a supply line, and R-134a is allowed to enter the tank. The amount of heat transfer with the surroundings and the exergy destruction are to be determined.

**Assumptions 1** This is an unsteady process since the conditions within the device are changing during the process, but it can be analyzed as a uniform-flow process since the state of fluid at the inlet remains constant. **2** Kinetic and potential energies are negligible. **3** There are no work interactions involved. **4** The direction of heat transfer is from the tank (will be verified).

**Properties** The properties of refrigerant are (Tables A-11 through A-13)

$$P_1 = 1 \text{ MPa} \left\{ \begin{array}{l} u_1 = u_{g@1 \text{ MPa}} = 250.68 \text{ kJ/kg} \\ s_1 = s_{g@1 \text{ MPa}} = 0.91558 \text{ kJ/kg} \cdot \text{K} \\ \nu_1 = \nu_{g@1 \text{ MPa}} = 0.020313 \text{ m}^3 / \text{kg} \end{array} \right.$$

$$P_i = 1.4 \text{ MPa} \left\{ \begin{array}{l} h_i = 285.47 \text{ kJ/kg} \\ s_i = 0.93889 \text{ kJ/kg} \cdot \text{K} \end{array} \right.$$

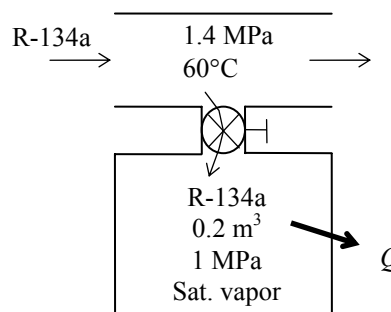

**Analysis** (a) We take the tank as the system, which is a control volume since mass crosses the boundary. Noting that the microscopic energies of flowing and nonflowing fluids are represented by enthalpy  $h$  and internal energy  $u$ , respectively, the mass and energy balances for this uniform-flow system can be expressed as

**Mass balance:**

$$m_{\text{in}} - m_{\text{out}} = \Delta m_{\text{system}} \rightarrow m_i = m_2 - m_1$$

**Energy balance:**

$$\underbrace{E_{\text{in}} - E_{\text{out}}}_{\text{Net energy transfer by heat, work, and mass}} = \underbrace{\Delta E_{\text{system}}}_{\text{Change in internal, kinetic, potential, etc. energies}}$$

$$m_i h_i - Q_{\text{out}} = m_2 u_2 - m_1 u_1 \quad (\text{since } W \cong ke \cong pe \cong 0)$$

The initial and the final masses in the tank are

$$m_1 = \frac{\nu}{\nu_1} = \frac{0.2 \text{ m}^3}{0.020313 \text{ m}^3 / \text{kg}} = 9.846 \text{ kg}$$

$$m_2 = m_f + m_g = \frac{\nu_f}{\nu_f} + \frac{\nu_g}{\nu_g} = \frac{0.1 \text{ m}^3}{0.0008934 \text{ m}^3 / \text{kg}} + \frac{0.1 \text{ m}^3}{0.016715 \text{ m}^3 / \text{kg}} = 111.93 + 5.983 = 117.91 \text{ kg}$$

$$U_2 = m_2 u_2 = m_f u_f + m_g u_g = 111.93 \times 116.70 + 5.983 \times 253.81 = 14,581 \text{ kJ}$$

$$S_2 = m_2 s_2 = m_f s_f + m_g s_g = 111.93 \times 0.42441 + 5.983 \times 0.91303 = 52.967 \text{ kJ/K}$$

Then from the mass and energy balances,

$$m_i = m_2 - m_1 = 117.91 - 9.846 = 108.06 \text{ kg}$$

The heat transfer during this process is determined from the energy balance to be

$$Q_{\text{out}} = m_i h_i - m_2 u_2 + m_1 u_1 = 108.06 \times 285.47 - 14,581 + 9.846 \times 250.68 = \mathbf{18,737 \text{ kJ}}$$

(b) The exergy destroyed during a process can be determined from an exergy balance or directly from its definition  $X_{\text{destroyed}} = T_0 S_{\text{gen}}$ . The entropy generation  $S_{\text{gen}}$  in this case is determined from an entropy balance on an *extended system* that includes the cylinder and its immediate surroundings so that the boundary temperature of the extended system is the surroundings temperature  $T_{\text{surr}}$  at all times. It gives

$$\underbrace{S_{\text{in}} - S_{\text{out}}}_{\substack{\text{Net entropy transfer} \\ \text{by heat and mass}}} + \underbrace{S_{\text{gen}}}_{\substack{\text{Entropy} \\ \text{generation}}} = \underbrace{\Delta S_{\text{system}}}_{\substack{\text{Change} \\ \text{in entropy}}}$$

$$-\frac{Q_{\text{out}}}{T_{\text{b,out}}} + m_i s_i + S_{\text{gen}} = \Delta S_{\text{tank}} = (m_2 s_2 - m_1 s_1)_{\text{tank}}$$

$$S_{\text{gen}} = m_2 s_2 - m_1 s_1 - m_i s_i + \frac{Q_{\text{out}}}{T_0}$$

Substituting, the exergy destruction is determined to be

$$X_{\text{destroyed}} = T_0 S_{\text{gen}} = T_0 \left[ m_2 s_2 - m_1 s_1 - m_i s_i + \frac{Q_{\text{out}}}{T_0} \right]$$

$$= (298 \text{ K}) [52.967 - 9.846 \times 0.91558 - 108.06 \times 0.93889 + 18,737 / 298]$$

$$= \mathbf{1599 \text{ kJ}}$$

**8-87** An insulated cylinder initially contains saturated liquid-vapor mixture of water. The cylinder is connected to a supply line, and the steam is allowed to enter the cylinder until all the liquid is vaporized. The amount of steam that entered the cylinder and the exergy destroyed are to be determined.

**Assumptions 1** This is an unsteady process since the conditions within the device are changing during the process, but it can be analyzed as a uniform-flow process since the state of fluid at the inlet remains constant. **2** The expansion process is quasi-equilibrium. **3** Kinetic and potential energies are negligible. **4** The device is insulated and thus heat transfer is negligible.

**Properties** The properties of steam are (Tables A-4 through A-6)

$$P_1 = 200 \text{ kPa} \quad \left. \begin{array}{l} h_1 = h_f + x_1 h_{fg} = 504.71 + 0.6 \times 2201.6 = 1825.6 \text{ kJ/kg} \\ x_1 = 9/15 = 0.6 \end{array} \right\} \begin{array}{l} s_1 = s_f + x_1 s_{fg} = 1.5302 + 0.6 \times 5.5968 = 4.8883 \text{ kJ/kg} \cdot \text{K} \end{array}$$

$$P_2 = 200 \text{ kPa} \quad \left. \begin{array}{l} h_2 = h_{g@200 \text{ kPa}} = 2706.3 \text{ kJ/kg} \\ \text{sat. vapor} \end{array} \right\} \begin{array}{l} s_2 = s_{g@200 \text{ kPa}} = 7.1270 \text{ kJ/kg} \cdot \text{K} \end{array}$$

$$P_i = 1 \text{ MPa} \quad \left. \begin{array}{l} h_i = 3264.5 \text{ kJ/kg} \\ T_i = 400^\circ\text{C} \end{array} \right\} \begin{array}{l} s_i = 7.4670 \text{ kJ/kg} \cdot \text{K} \end{array}$$

**Analysis (a)** We take the cylinder as the system, which is a control volume. Noting that the microscopic energies of flowing and nonflowing fluids are represented by enthalpy  $h$  and internal energy  $u$ , respectively, the mass and energy balances for this unsteady-flow system can be expressed as

$$\text{Mass balance:} \quad m_{\text{in}} - m_{\text{out}} = \Delta m_{\text{system}} \rightarrow m_i = m_2 - m_1$$

**Energy balance:**

$$\underbrace{E_{\text{in}} - E_{\text{out}}}_{\substack{\text{Net energy transfer} \\ \text{by heat, work, and mass}}} = \underbrace{\Delta E_{\text{system}}}_{\substack{\text{Change in internal, kinetic,} \\ \text{potential, etc. energies}}}$$

$$m_i h_i = W_{\text{b,out}} + m_2 u_2 - m_1 u_1 \quad (\text{since } Q \cong \text{ke} \cong \text{pe} \cong 0)$$

$$\text{Combining the two relations gives} \quad 0 = W_{\text{b,out}} - (m_2 - m_1) h_i + m_2 u_2 - m_1 u_1$$

$$\text{or,} \quad 0 = -(m_2 - m_1) h_i + m_2 h_2 - m_1 h_1$$

since the boundary work and  $\Delta U$  combine into  $\Delta H$  for constant pressure expansion and compression processes. Solving for  $m_2$  and substituting,

$$m_2 = \frac{h_i - h_1}{h_i - h_2} m_1 = \frac{(3264.5 - 1825.6) \text{ kJ/kg}}{(3264.5 - 2706.3) \text{ kJ/kg}} (15 \text{ kg}) = 38.66 \text{ kg}$$

$$\text{Thus,} \quad m_i = m_2 - m_1 = 38.66 - 15 = \mathbf{23.66 \text{ kg}}$$

**(b)** The exergy destroyed during a process can be determined from an exergy balance or directly from its definition  $X_{\text{destroyed}} = T_0 S_{\text{gen}}$  where the entropy generation  $S_{\text{gen}}$  is determined from an entropy balance on the insulated cylinder,

$$\underbrace{S_{\text{in}} - S_{\text{out}}}_{\substack{\text{Net entropy transfer} \\ \text{by heat and mass}}} + \underbrace{S_{\text{gen}}}_{\substack{\text{Entropy} \\ \text{generation}}} = \underbrace{\Delta S_{\text{system}}}_{\substack{\text{Change} \\ \text{in entropy}}}$$

$$m_i s_i + S_{\text{gen}} = \Delta S_{\text{system}} = m_2 s_2 - m_1 s_1$$

$$S_{\text{gen}} = m_2 s_2 - m_1 s_1 - m_i s_i$$

Substituting, the exergy destruction is determined to be

$$\begin{aligned} X_{\text{destroyed}} &= T_0 S_{\text{gen}} = T_0 [m_2 s_2 - m_1 s_1 - m_i s_i] \\ &= (298 \text{ K})(38.66 \times 7.1270 - 15 \times 4.8883 - 23.66 \times 7.4670) = \mathbf{7610 \text{ kJ}} \end{aligned}$$

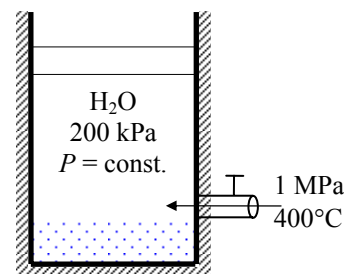

**8-88** Each member of a family of four takes a shower every day. The amount of exergy destroyed by this family per year is to be determined.

**Assumptions** **1** Steady operating conditions exist. **2** The kinetic and potential energies are negligible. **3** Heat losses from the pipes, mixing section are negligible and thus  $\dot{Q} \cong 0$ . **4** Showers operate at maximum flow conditions during the entire shower. **5** Each member of the household takes a shower every day. **6** Water is an incompressible substance with constant properties at room temperature. **7** The efficiency of the electric water heater is 100%.

**Properties** The density and specific heat of water are at room temperature are  $\rho = 1 \text{ kg/L} = 1000 \text{ kg/m}^3$  and  $c = 4.18 \text{ kJ/kg}\cdot^\circ\text{C}$  (Table A-3).

**Analysis** The mass flow rate of water at the shower head is

$$\dot{m} = \rho \dot{V} = (1 \text{ kg/L})(10 \text{ L/min}) = 10 \text{ kg/min}$$

The mass balance for the mixing chamber can be expressed in the rate form as

$$\dot{m}_{\text{in}} - \dot{m}_{\text{out}} = \Delta \dot{m}_{\text{system}} \stackrel{\approx 0 \text{ (steady)}}{=} 0 \rightarrow \dot{m}_{\text{in}} = \dot{m}_{\text{out}} \rightarrow \dot{m}_1 + \dot{m}_2 = \dot{m}_3$$

where the subscript 1 denotes the cold water stream, 2 the hot water stream, and 3 the mixture.

The rate of entropy generation during this process can be determined by applying the rate form of the entropy balance on a system that includes the electric water heater and the mixing chamber (the T-elbow). Noting that there is no entropy transfer associated with work transfer (electricity) and there is no heat transfer, the entropy balance for this steady-flow system can be expressed as

$$\underbrace{\dot{S}_{\text{in}} - \dot{S}_{\text{out}}}_{\text{Rate of net entropy transfer by heat and mass}} + \underbrace{\dot{S}_{\text{gen}}}_{\text{Rate of entropy generation}} = \underbrace{\Delta \dot{S}_{\text{system}}}_{\text{Rate of change of entropy}} \stackrel{\approx 0 \text{ (steady)}}{=} 0$$

$$\dot{m}_1 s_1 + \dot{m}_2 s_2 - \dot{m}_3 s_3 + \dot{S}_{\text{gen}} = 0 \quad (\text{since } \dot{Q} = 0 \text{ and work is entropy free})$$

$$\dot{S}_{\text{gen}} = \dot{m}_3 s_3 - \dot{m}_1 s_1 - \dot{m}_2 s_2$$

Noting from mass balance that  $\dot{m}_1 + \dot{m}_2 = \dot{m}_3$  and  $s_2 = s_1$  since hot water enters the system at the same temperature as the cold water, the rate of entropy generation is determined to be

$$\dot{S}_{\text{gen}} = \dot{m}_3 s_3 - (\dot{m}_1 + \dot{m}_2) s_1 = \dot{m}_3 (s_3 - s_1) = \dot{m}_3 c_p \ln \frac{T_3}{T_1}$$

$$= (10 \text{ kg/min})(4.18 \text{ kJ/kg}\cdot\text{K}) \ln \frac{42 + 273}{15 + 273} = 3.746 \text{ kJ/min}\cdot\text{K}$$

Noting that 4 people take a 6-min shower every day, the amount of entropy generated per year is

$$S_{\text{gen}} = (\dot{S}_{\text{gen}}) \Delta t (\text{No. of people}) (\text{No. of days})$$

$$= (3.746 \text{ kJ/min}\cdot\text{K})(6 \text{ min/person}\cdot\text{day})(4 \text{ persons})(365 \text{ days/year})$$

$$= 32,815 \text{ kJ/K (per year)}$$

The exergy destroyed during a process can be determined from an exergy balance or directly from its definition  $X_{\text{destroyed}} = T_0 S_{\text{gen}}$ ,

$$X_{\text{destroyed}} = T_0 S_{\text{gen}} = (298 \text{ K})(32,815 \text{ kJ/K}) = \mathbf{9,779,000 \text{ kJ}}$$

**Discussion** The value above represents the exergy destroyed within the water heater and the T-elbow in the absence of any heat losses. It does not include the exergy destroyed as the shower water at 42°C is discarded or cooled to the outdoor temperature. Also, an entropy balance on the mixing chamber alone (hot water entering at 55°C instead of 15°C) will exclude the exergy destroyed within the water heater.

**8-89** Air is compressed in a steady-flow device isentropically. The work done, the exit exergy of compressed air, and the exergy of compressed air after it is cooled to ambient temperature are to be determined.

**Assumptions 1** Air is an ideal gas with constant specific heats at room temperature. **2** The process is given to be reversible and adiabatic, and thus isentropic. Therefore, isentropic relations of ideal gases apply. **3** The environment temperature and pressure are given to be 300 K and 100 kPa. **4** The kinetic and potential energies are negligible.

**Properties** The gas constant of air is  $R = 0.287 \text{ kJ/kg}\cdot\text{K}$  (Table A-1). The constant pressure specific heat and specific heat ratio of air at room temperature are  $c_p = 1.005 \text{ kJ/kg}\cdot\text{K}$  and  $k = 1.4$  (Table A-2).

**Analysis** (a) From the constant specific heats ideal gas isentropic relations,

$$T_2 = T_1 \left( \frac{P_2}{P_1} \right)^{(k-1)/k} = (300 \text{ K}) \left( \frac{1000 \text{ kPa}}{100 \text{ kPa}} \right)^{0.4/1.4} = 579.2 \text{ K}$$

For a steady-flow isentropic compression process, the work input is determined from

$$\begin{aligned} w_{\text{comp, in}} &= \frac{kRT_1}{k-1} \left\{ \left( P_2/P_1 \right)^{(k-1)/k} - 1 \right\} \\ &= \frac{(1.4)(0.287 \text{ kJ/kg}\cdot\text{K})(300 \text{ K})}{1.4-1} \left\{ (1000/100)^{0.4/1.4} - 1 \right\} \\ &= \mathbf{280.5 \text{ kJ/kg}} \end{aligned}$$

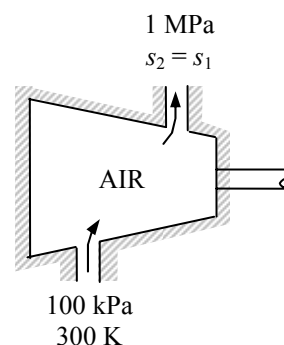

(b) The exergy of air at the compressor exit is simply the flow exergy at the exit state,

$$\begin{aligned} \psi_2 &= h_2 - h_0 - T_0(s_2 - s_0) + \frac{V_2^2}{2} + gz_2 \quad (\text{since the process } 0-2 \text{ is isentropic}) \\ &= c_p(T_2 - T_0) \\ &= (1.005 \text{ kJ/kg}\cdot\text{K})(579.2 - 300) \text{ K} = \mathbf{280.6 \text{ kJ/kg}} \end{aligned}$$

which is the same as the compressor work input. This is not surprising since the compression process is reversible.

(c) The exergy of compressed air at 1 MPa after it is cooled to 300 K is again the flow exergy at that state,

$$\begin{aligned} \psi_3 &= h_3 - h_0 - T_0(s_3 - s_0) + \frac{V_3^2}{2} + gz_3 \\ &= c_p(T_3 - T_0) - T_0(s_3 - s_0) \quad (\text{since } T_3 = T_0 = 300 \text{ K}) \\ &= -T_0(s_3 - s_0) \end{aligned}$$

where

$$s_3 - s_0 = c_p \ln \frac{T_3}{T_0} - R \ln \frac{P_3}{P_0} = -R \ln \frac{P_3}{P_0} = -(0.287 \text{ kJ/kg}\cdot\text{K}) \ln \frac{1000 \text{ kPa}}{100 \text{ kPa}} = -0.661 \text{ kJ/kg}\cdot\text{K}$$

Substituting,

$$\psi_3 = -(300 \text{ K})(-0.661 \text{ kJ/kg}\cdot\text{K}) = \mathbf{198 \text{ kJ/kg}}$$

Note that the exergy of compressed air decreases from 280.6 to 198 as it is cooled to ambient temperature.

**8-90** Air is preheated by hot exhaust gases in a cross-flow heat exchanger. The rate of heat transfer and the rate of exergy destruction in the heat exchanger are to be determined.

**Assumptions** **1** Steady operating conditions exist. **2** The heat exchanger is well-insulated so that heat loss to the surroundings is negligible and thus heat transfer from the hot fluid is equal to the heat transfer to the cold fluid. **3** Changes in the kinetic and potential energies of fluid streams are negligible. **4** Fluid properties are constant.

**Properties** The specific heats of air and combustion gases are given to be 1.005 and 1.10 kJ/kg·°C, respectively. The gas constant of air is  $R = 0.287$  kJ/kg·K (Table A-1).

**Analysis** We take the exhaust pipes as the system, which is a control volume. The energy balance for this steady-flow system can be expressed in the rate form as

$$\underbrace{\dot{E}_{\text{in}} - \dot{E}_{\text{out}}}_{\text{Rate of net energy transfer by heat, work, and mass}} = \underbrace{\Delta \dot{E}_{\text{system}}^{\approx 0} (\text{steady})}_{\text{Rate of change in internal, kinetic, potential, etc. energies}} = 0$$

$$\dot{E}_{\text{in}} = \dot{E}_{\text{out}}$$

$$\dot{m}h_1 = \dot{Q}_{\text{out}} + \dot{m}h_2 \quad (\text{since } \Delta ke \cong \Delta pe \cong 0)$$

$$\dot{Q}_{\text{out}} = \dot{m}C_p(T_1 - T_2)$$

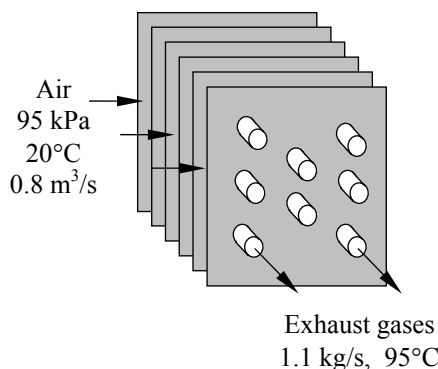

Then the rate of heat transfer from the exhaust gases becomes

$$\dot{Q} = [\dot{m}c_p(T_{\text{in}} - T_{\text{out}})]_{\text{gas.}} = (1.1 \text{ kg/s})(1.1 \text{ kJ/kg} \cdot ^\circ\text{C})(180^\circ\text{C} - 95^\circ\text{C}) = \mathbf{102.85 \text{ kW}}$$

The mass flow rate of air is

$$\dot{m} = \frac{P\dot{V}}{RT} = \frac{(95 \text{ kPa})(0.8 \text{ m}^3/\text{s})}{(0.287 \text{ kPa} \cdot \text{m}^3/\text{kg} \cdot \text{K}) \times 293 \text{ K}} = 0.904 \text{ kg/s}$$

Noting that heat loss by exhaust gases is equal to the heat gain by the air, the air exit temperature becomes

$$\dot{Q} = [\dot{m}C_p(T_{\text{out}} - T_{\text{in}})]_{\text{air}} \rightarrow T_{\text{out}} = T_{\text{in}} + \frac{\dot{Q}}{\dot{m}c_p} = 20^\circ\text{C} + \frac{102.85 \text{ kW}}{(0.904 \text{ kg/s})(1.005 \text{ kJ/kg} \cdot ^\circ\text{C})} = 133.2^\circ\text{C}$$

The rate of entropy generation within the heat exchanger is determined by applying the rate form of the entropy balance on the entire heat exchanger:

$$\underbrace{\dot{S}_{\text{in}} - \dot{S}_{\text{out}}}_{\text{Rate of net entropy transfer by heat and mass}} + \underbrace{\dot{S}_{\text{gen}}}_{\text{Rate of entropy generation}} = \underbrace{\Delta \dot{S}_{\text{system}}^{\approx 0} (\text{steady})}_{\text{Rate of change of entropy}}$$

$$\dot{m}_1s_1 + \dot{m}_3s_3 - \dot{m}_2s_2 - \dot{m}_4s_4 + \dot{S}_{\text{gen}} = 0 \quad (\text{since } \dot{Q} = 0)$$

$$\dot{m}_{\text{exhaust}}s_1 + \dot{m}_{\text{air}}s_3 - \dot{m}_{\text{exhaust}}s_2 - \dot{m}_{\text{air}}s_4 + \dot{S}_{\text{gen}} = 0$$

$$\dot{S}_{\text{gen}} = \dot{m}_{\text{exhaust}}(s_2 - s_1) + \dot{m}_{\text{air}}(s_4 - s_3)$$

Noting that both fluid streams are liquids (incompressible substances), the rate of entropy generation is

$$\begin{aligned} \dot{S}_{\text{gen}} &= \dot{m}_{\text{exhaust}}c_p \ln \frac{T_2}{T_1} + \dot{m}_{\text{air}}c_p \ln \frac{T_4}{T_3} \\ &= (1.1 \text{ kg/s})(1.1 \text{ kJ/kg} \cdot \text{K}) \ln \frac{95 + 273}{180 + 273} + (0.904 \text{ kg/s})(1.005 \text{ kJ/kg} \cdot \text{K}) \ln \frac{133.2 + 273}{20 + 273} = 0.0453 \text{ kW/K} \end{aligned}$$

The exergy destroyed during a process can be determined from an exergy balance or directly from its definition  $X_{\text{destroyed}} = T_0\dot{S}_{\text{gen}}$ ,

$$\dot{X}_{\text{destroyed}} = T_0\dot{S}_{\text{gen}} = (293 \text{ K})(0.0453 \text{ kW/K}) = \mathbf{13.3 \text{ kW}}$$



**8-91** Water is heated by hot oil in a heat exchanger. The outlet temperature of the oil and the rate of exergy destruction within the heat exchanger are to be determined.

**Assumptions** **1** Steady operating conditions exist. **2** The heat exchanger is well-insulated so that heat loss to the surroundings is negligible and thus heat transfer from the hot fluid is equal to the heat transfer to the cold fluid. **3** Changes in the kinetic and potential energies of fluid streams are negligible. **4** Fluid properties are constant.

**Properties** The specific heats of water and oil are given to be 4.18 and 2.3 kJ/kg·°C, respectively.

**Analysis** We take the cold water tubes as the system, which is a control volume. The energy balance for this steady-flow system can be expressed in the rate form as

$$\underbrace{\dot{E}_{\text{in}} - \dot{E}_{\text{out}}}_{\substack{\text{Rate of net energy transfer} \\ \text{by heat, work, and mass}}} = \underbrace{\Delta \dot{E}_{\text{system}}}_{\substack{\text{Rate of change in internal, kinetic,} \\ \text{potential, etc. energies}}} \stackrel{\text{no (steady)}}{=} 0$$

$$\dot{E}_{\text{in}} = \dot{E}_{\text{out}}$$

$$\dot{Q}_{\text{in}} + \dot{m}h_1 = \dot{m}h_2 \quad (\text{since } \Delta \text{ke} \cong \Delta \text{pe} \cong 0)$$

$$\dot{Q}_{\text{in}} = \dot{m}c_p(T_2 - T_1)$$

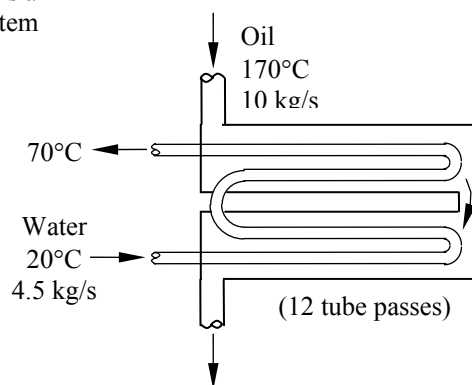

Then the rate of heat transfer to the cold water in this heat exchanger becomes

$$\dot{Q} = [\dot{m}c_p(T_{\text{out}} - T_{\text{in}})]_{\text{water}} = (4.5 \text{ kg/s})(4.18 \text{ kJ/kg} \cdot \text{°C})(70\text{°C} - 20\text{°C}) = 940.5 \text{ kW}$$

Noting that heat gain by the water is equal to the heat loss by the oil, the outlet temperature of the hot water is determined from

$$\dot{Q} = [\dot{m}c_p(T_{\text{in}} - T_{\text{out}})]_{\text{oil}} \rightarrow T_{\text{out}} = T_{\text{in}} - \frac{\dot{Q}}{\dot{m}c_p} = 170\text{°C} - \frac{940.5 \text{ kW}}{(10 \text{ kg/s})(2.3 \text{ kJ/kg} \cdot \text{°C})} = 129.1\text{°C}$$

(b) The rate of entropy generation within the heat exchanger is determined by applying the rate form of the entropy balance on the entire heat exchanger:

$$\underbrace{\dot{S}_{\text{in}} - \dot{S}_{\text{out}}}_{\substack{\text{Rate of net entropy transfer} \\ \text{by heat and mass}}} + \underbrace{\dot{S}_{\text{gen}}}_{\substack{\text{Rate of entropy} \\ \text{generation}}} = \underbrace{\Delta \dot{S}_{\text{system}}}_{\substack{\text{Rate of change} \\ \text{of entropy}}} \stackrel{\text{no (steady)}}{=} 0$$

$$\dot{m}_1 s_1 + \dot{m}_3 s_3 - \dot{m}_2 s_2 - \dot{m}_4 s_4 + \dot{S}_{\text{gen}} = 0 \quad (\text{since } \dot{Q} = 0)$$

$$\dot{m}_{\text{water}} s_1 + \dot{m}_{\text{oil}} s_3 - \dot{m}_{\text{water}} s_2 - \dot{m}_{\text{oil}} s_4 + \dot{S}_{\text{gen}} = 0$$

$$\dot{S}_{\text{gen}} = \dot{m}_{\text{water}}(s_2 - s_1) + \dot{m}_{\text{oil}}(s_4 - s_3)$$

Noting that both fluid streams are liquids (incompressible substances), the rate of entropy generation is determined to be

$$\dot{S}_{\text{gen}} = \dot{m}_{\text{water}} c_p \ln \frac{T_2}{T_1} + \dot{m}_{\text{oil}} c_p \ln \frac{T_4}{T_3}$$

$$= (4.5 \text{ kg/s})(4.18 \text{ kJ/kg} \cdot \text{K}) \ln \frac{70 + 273}{20 + 273} + (10 \text{ kg/s})(2.3 \text{ kJ/kg} \cdot \text{K}) \ln \frac{129.1 + 273}{170 + 273} = 0.736 \text{ kW/K}$$

The exergy destroyed during a process can be determined from an exergy balance or directly from its definition  $X_{\text{destroyed}} = T_0 \dot{S}_{\text{gen}}$ ,

$$\dot{X}_{\text{destroyed}} = T_0 \dot{S}_{\text{gen}} = (298 \text{ K})(0.736 \text{ kW/K}) = 219 \text{ kW}$$

**8-92E** Steam is condensed by cooling water in a condenser. The rate of heat transfer and the rate of exergy destruction within the heat exchanger are to be determined.

**Assumptions** **1** Steady operating conditions exist. **2** The heat exchanger is well-insulated so that heat loss to the surroundings is negligible and thus heat transfer from the hot fluid is equal to the heat transfer to the cold fluid. **3** Changes in the kinetic and potential energies of fluid streams are negligible. **4** Fluid properties are constant. **5** The temperature of the environment is 77°F.

**Properties** The specific heat of water is 1.0 Btu/lbm·°F (Table A-3E). The enthalpy and entropy of vaporization of water at 120°F are 1025.2 Btu/lbm and  $s_{fg} = 1.7686$  Btu/lbm·R (Table A-4E).

**Analysis** We take the tube-side of the heat exchanger where cold water is flowing as the system, which is a control volume. The energy balance for this steady-flow system can be expressed in the rate form as

$$\underbrace{\dot{E}_{in} - \dot{E}_{out}}_{\text{Rate of net energy transfer by heat, work, and mass}} = \underbrace{\Delta \dot{E}_{system}^{\text{?0 (steady)}}}_{\text{Rate of change in internal, kinetic, potential, etc. energies}} = 0$$

$$\dot{E}_{in} = \dot{E}_{out}$$

$$\dot{Q}_{in} + \dot{m}h_1 = \dot{m}h_2 \quad (\text{since } \Delta ke \cong \Delta pe \cong 0)$$

$$\dot{Q}_{in} = \dot{m}c_p(T_2 - T_1)$$

Then the rate of heat transfer to the cold water in this heat exchanger becomes

$$\begin{aligned} \dot{Q} &= [\dot{m}c_p(T_{out} - T_{in})]_{\text{water}} \\ &= (115.3 \text{ lbm/s})(1.0 \text{ Btu/lbm}\cdot\text{°F})(73\text{°F} - 60\text{°F}) = \mathbf{1499 \text{ Btu/s}} \end{aligned}$$

Noting that heat gain by the water is equal to the heat loss by the condensing steam, the rate of condensation of the steam in the heat exchanger is determined from

$$\dot{Q} = (\dot{m}h_{fg})_{\text{steam}} = \dot{m}_{\text{steam}} = \frac{\dot{Q}}{h_{fg}} = \frac{1499 \text{ Btu/s}}{1025.2 \text{ Btu/lbm}} = 1.462 \text{ lbm/s}$$

(b) The rate of entropy generation within the heat exchanger is determined by applying the rate form of the entropy balance on the entire heat exchanger:

$$\underbrace{\dot{S}_{in} - \dot{S}_{out}}_{\text{Rate of net entropy transfer by heat and mass}} + \underbrace{\dot{S}_{gen}}_{\text{Rate of entropy generation}} = \underbrace{\Delta \dot{S}_{system}^{\text{?0 (steady)}}}_{\text{Rate of change of entropy}}$$

$$\dot{m}_1 s_1 + \dot{m}_3 s_3 - \dot{m}_2 s_2 - \dot{m}_4 s_4 + \dot{S}_{gen} = 0 \quad (\text{since } \dot{Q} = 0)$$

$$\dot{m}_{\text{water}} s_1 + \dot{m}_{\text{steam}} s_3 - \dot{m}_{\text{water}} s_2 - \dot{m}_{\text{steam}} s_4 + \dot{S}_{gen} = 0$$

$$\dot{S}_{gen} = \dot{m}_{\text{water}}(s_2 - s_1) + \dot{m}_{\text{steam}}(s_4 - s_3)$$

Noting that water is an incompressible substance and steam changes from saturated vapor to saturated liquid, the rate of entropy generation is determined to be

$$\begin{aligned} \dot{S}_{gen} &= \dot{m}_{\text{water}} c_p \ln \frac{T_2}{T_1} + \dot{m}_{\text{steam}}(s_f - s_g) = \dot{m}_{\text{water}} c_p \ln \frac{T_2}{T_1} - \dot{m}_{\text{steam}} s_{fg} \\ &= (115.3 \text{ lbm/s})(1.0 \text{ Btu/lbm}\cdot\text{R}) \ln \frac{73 + 460}{60 + 460} - (1.462 \text{ lbm/s})(1.7686 \text{ Btu/lbm}\cdot\text{R}) = 0.2613 \text{ Btu/s}\cdot\text{R} \end{aligned}$$

The exergy destroyed during a process can be determined from an exergy balance or directly from its definition  $X_{\text{destroyed}} = T_0 \dot{S}_{gen}$ ,

$$\dot{X}_{\text{destroyed}} = T_0 \dot{S}_{gen} = (537 \text{ R})(0.2613 \text{ Btu/s}\cdot\text{R}) = \mathbf{140.3 \text{ Btu/s}}$$

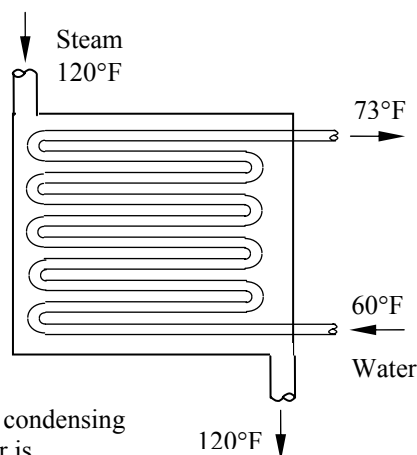

**8-93** Steam expands in a turbine, which is not insulated. The reversible power, the exergy destroyed, the second-law efficiency, and the possible increase in the turbine power if the turbine is well insulated are to be determined.

**Assumptions** 1 Steady operating conditions exist. 2 Potential energy change is negligible.

**Analysis** (a) The properties of the steam at the inlet and exit of the turbine are (Tables A-4 through A-6)

$$\begin{aligned} P_1 = 12 \text{ MPa} & \left. \begin{array}{l} h_1 = 3481.7 \text{ kJ/kg} \\ T_1 = 550^\circ\text{C} \end{array} \right\} s_1 = 6.6554 \text{ kJ/kg}\cdot\text{K} \\ P_2 = 20 \text{ kPa} & \left. \begin{array}{l} h_2 = 2491.1 \text{ kJ/kg} \\ x_2 = 0.95 \end{array} \right\} s_2 = 7.5535 \text{ kJ/kg}\cdot\text{K} \end{aligned}$$

The enthalpy at the dead state is

$$\begin{aligned} T_0 = 25^\circ\text{C} & \left. \begin{array}{l} h_0 = 104.83 \text{ kJ/kg} \\ x = 0 \end{array} \right\} \end{aligned}$$

The mass flow rate of steam may be determined from an energy balance on the turbine

$$\begin{aligned} \dot{m} \left( h_1 + \frac{V_1^2}{2} \right) &= \dot{m} \left( h_2 + \frac{V_2^2}{2} \right) + \dot{Q}_{\text{out}} + \dot{W}_a \\ \dot{m} \left[ 3481.7 \text{ kJ/kg} + \frac{(60 \text{ m/s})^2}{2} \left( \frac{1 \text{ kJ/kg}}{1000 \text{ m}^2/\text{s}^2} \right) \right] &= \dot{m} \left[ 2491.1 \text{ kJ/kg} + \frac{(130 \text{ m/s})^2}{2} \left( \frac{1 \text{ kJ/kg}}{1000 \text{ m}^2/\text{s}^2} \right) \right] \\ + 150 \text{ kW} + 2500 \text{ kW} &\longrightarrow \dot{m} = 2.693 \text{ kg/s} \end{aligned}$$

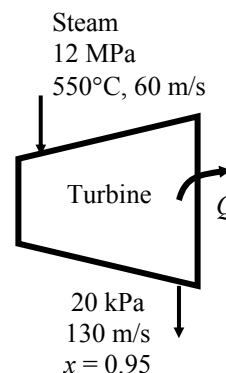

The reversible power may be determined from

$$\begin{aligned} \dot{W}_{\text{rev}} &= \dot{m} \left[ h_1 - h_2 - T_0 (s_1 - s_2) + \frac{V_1^2 - V_2^2}{2} \right] \\ &= (2.693) \left[ (3481.7 - 2491.1) - (298)(6.6554 - 7.5535) + \frac{(60 \text{ m/s})^2 - (130 \text{ m/s})^2}{2} \left( \frac{1 \text{ kJ/kg}}{1000 \text{ m}^2/\text{s}^2} \right) \right] \\ &= \mathbf{3371 \text{ kW}} \end{aligned}$$

(b) The exergy destroyed in the turbine is

$$\dot{X}_{\text{dest}} = \dot{W}_{\text{rev}} - \dot{W}_a = 3371 - 2500 = \mathbf{871 \text{ kW}}$$

(c) The second-law efficiency is

$$\eta_{II} = \frac{\dot{W}_a}{\dot{W}_{\text{rev}}} = \frac{2500 \text{ kW}}{3371 \text{ kW}} = \mathbf{0.742}$$

(d) The energy of the steam at the turbine inlet in the given dead state is

$$\dot{Q} = \dot{m}(h_1 - h_0) = (2.693 \text{ kg/s})(3481.7 - 104.83) \text{ kJ/kg} = 9095 \text{ kW}$$

The fraction of energy at the turbine inlet that is converted to power is

$$f = \frac{\dot{W}_a}{\dot{Q}} = \frac{2500 \text{ kW}}{9095 \text{ kW}} = 0.2749$$

Assuming that the same fraction of heat loss from the turbine could have been converted to work, the possible increase in the power if the turbine is to be well-insulated becomes

$$\dot{W}_{\text{increase}} = f\dot{Q}_{\text{out}} = (0.2749)(150 \text{ kW}) = \mathbf{41.2 \text{ kW}}$$

**8-94** Air is compressed in a compressor that is intentionally cooled. The actual and reversible power inputs, the second law efficiency, and the mass flow rate of cooling water are to be determined.

**Assumptions** 1 Steady operating conditions exist. 2 Potential energy change is negligible. 3 Air is an ideal gas with constant specific heats.

**Properties** The gas constant of air is  $R = 0.287 \text{ kJ/kg}\cdot\text{K}$  and the specific heat of air at room is  $c_p = 1.005 \text{ kJ/kg}\cdot\text{K}$ . the specific heat of water at room temperature is  $c_w = 4.18 \text{ kJ/kg}\cdot\text{K}$  (Tables A-2, A-3).

**Analysis** (a) The mass flow rate of air is

$$\dot{m} = \rho \dot{V}_1 = \frac{P_1}{RT_1} \dot{V}_1 = \frac{(100 \text{ kPa})}{(0.287 \text{ kJ/kg}\cdot\text{K})(20 + 273 \text{ K})} (4.5 \text{ m}^3/\text{s}) = 5.351 \text{ kg/s}$$

The power input for a reversible-isothermal process is given by

$$\dot{W}_{\text{rev}} = \dot{m}RT_1 \ln \frac{P_2}{P_1} = (5.351 \text{ kg/s})(0.287 \text{ kJ/kg}\cdot\text{K})(20 + 273 \text{ K}) \ln \left( \frac{900 \text{ kPa}}{100 \text{ kPa}} \right) = \mathbf{988.8 \text{ kW}}$$

Given the isothermal efficiency, the actual power may be determined from

$$\dot{W}_{\text{actual}} = \frac{\dot{W}_{\text{rev}}}{\eta_T} = \frac{988.8 \text{ kW}}{0.70} = \mathbf{1413 \text{ kW}}$$

(b) The given isothermal efficiency is actually the second-law efficiency of the compressor

$$\eta_{\text{II}} = \eta_T = \mathbf{0.70}$$

(c) An energy balance on the compressor gives

$$\begin{aligned} \dot{Q}_{\text{out}} &= \dot{m} \left[ c_p (T_1 - T_2) + \frac{V_1^2 - V_2^2}{2} \right] + \dot{W}_{\text{actual, in}} \\ &= (5.351 \text{ kg/s}) \left[ (1.005 \text{ kJ/kg}\cdot\text{K})(20 - 60)^\circ\text{C} + \frac{0 - (80 \text{ m/s})^2}{2} \left( \frac{1 \text{ kJ/kg}}{1000 \text{ m}^2/\text{s}^2} \right) \right] + 1413 \text{ kW} \\ &= \mathbf{1181 \text{ kW}} \end{aligned}$$

The mass flow rate of the cooling water is

$$\dot{m}_w = \frac{\dot{Q}_{\text{out}}}{c_w \Delta T} = \frac{1181 \text{ kW}}{(4.18 \text{ kJ/kg}\cdot\text{K})(10^\circ\text{C})} = \mathbf{28.25 \text{ kg/s}}$$

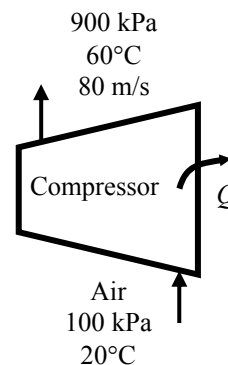

**8-95** Water is heated in a chamber by mixing it with saturated steam. The temperature of the steam entering the chamber, the exergy destruction, and the second-law efficiency are to be determined.

**Assumptions** 1 Steady operating conditions exist. 2 Kinetic and potential energy changes are negligible. 3 Heat loss from the chamber is negligible.

**Analysis** (a) The properties of water are (Tables A-4 through A-6)

$$\begin{aligned} T_1 = 15^\circ\text{C} \quad & \left. \begin{aligned} h_1 = h_0 = 62.98 \text{ kJ/kg} \\ x_1 = 0 \end{aligned} \right\} s_1 = s_0 = 0.22447 \text{ kJ/kg}\cdot\text{K} \\ T_3 = 45^\circ\text{C} \quad & \left. \begin{aligned} h_3 = 188.44 \text{ kJ/kg} \\ x_1 = 0 \end{aligned} \right\} s_3 = 0.63862 \text{ kJ/kg}\cdot\text{K} \end{aligned}$$

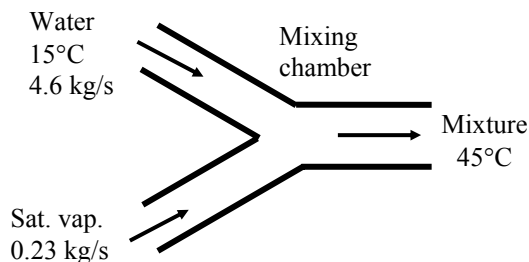

An energy balance on the chamber gives

$$\begin{aligned} \dot{m}_1 h_1 + \dot{m}_2 h_2 &= \dot{m}_3 h_3 = (\dot{m}_1 + \dot{m}_2) h_3 \\ (4.6 \text{ kg/s})(62.98 \text{ kJ/kg}) + (0.23 \text{ kg/s})h_2 &= (4.6 + 0.23 \text{ kg/s})(188.44 \text{ kJ/kg}) \\ h_2 &= 2697.5 \text{ kJ/kg} \end{aligned}$$

The remaining properties of the saturated steam are

$$\begin{aligned} h_2 = 2697.5 \text{ kJ/kg} \quad & \left. \begin{aligned} T_2 = \mathbf{114.3^\circ\text{C}} \\ x_2 = 1 \end{aligned} \right\} s_2 = 7.1907 \text{ kJ/kg}\cdot\text{K} \end{aligned}$$

(b) The specific exergy of each stream is

$$\begin{aligned} \psi_1 &= 0 \\ \psi_2 &= h_2 - h_0 - T_0(s_2 - s_0) \\ &= (2697.5 - 62.98) \text{ kJ/kg} - (15 + 273 \text{ K})(7.1907 - 0.22447) \text{ kJ/kg}\cdot\text{K} = 628.28 \text{ kJ/kg} \\ \psi_3 &= h_3 - h_0 - T_0(s_3 - s_0) \\ &= (188.44 - 62.98) \text{ kJ/kg} - (15 + 273 \text{ K})(0.63862 - 0.22447) \text{ kJ/kg}\cdot\text{K} = 6.18 \text{ kJ/kg} \end{aligned}$$

The exergy destruction is determined from an exergy balance on the chamber to be

$$\begin{aligned} \dot{X}_{\text{dest}} &= \dot{m}_1 \psi_1 + \dot{m}_2 \psi_2 - (\dot{m}_1 + \dot{m}_2) \psi_3 \\ &= 0 + (0.23 \text{ kg/s})(628.28 \text{ kJ/kg}) - (4.6 + 0.23 \text{ kg/s})(6.18 \text{ kJ/kg}) \\ &= \mathbf{114.7 \text{ kW}} \end{aligned}$$

(c) The second-law efficiency for this mixing process may be determined from

$$\eta_{\text{II}} = \frac{(\dot{m}_1 + \dot{m}_2) \psi_3}{\dot{m}_1 \psi_1 + \dot{m}_2 \psi_2} = \frac{(4.6 + 0.23 \text{ kg/s})(6.18 \text{ kJ/kg})}{0 + (0.23 \text{ kg/s})(628.28 \text{ kJ/kg})} = \mathbf{0.207}$$

## Review Problems

**8-96** Refrigerant-134a is expanded adiabatically in an expansion valve. The work potential of R-134a at the inlet, the exergy destruction, and the second-law efficiency are to be determined.

**Assumptions** 1 Steady operating conditions exist. 2 Kinetic and potential energy changes are negligible.

**Analysis** (a) The properties of the refrigerant at the inlet and exit of the valve and at dead state are (Tables A-11 through A-13)

$$\begin{aligned} P_1 = 1.2 \text{ MPa} & \left. \begin{aligned} h_1 &= 108.23 \text{ kJ/kg} \\ T_1 = 40^\circ\text{C} & \left. \begin{aligned} s_1 &= 0.39424 \text{ kJ/kg}\cdot\text{K} \end{aligned} \right\} \\ P_2 = 180 \text{ kPa} & \left. \begin{aligned} h_2 = h_1 = 108.23 \text{ kJ/kg} \\ s_2 &= 0.42271 \text{ kJ/kg}\cdot\text{K} \end{aligned} \right\} \\ P_0 = 100 \text{ kPa} & \left. \begin{aligned} h_0 &= 272.17 \text{ kJ/kg} \\ T_0 = 20^\circ\text{C} & \left. \begin{aligned} s_0 &= 1.0918 \text{ kJ/kg}\cdot\text{K} \end{aligned} \right\} \end{aligned} \right\} \end{aligned}$$

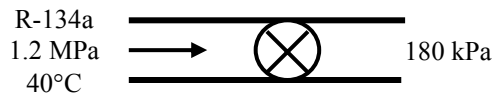

The specific exergy of the refrigerant at the inlet and exit of the valve are

$$\begin{aligned} \psi_1 &= h_1 - h_0 - T_0(s_1 - s_0) \\ &= (108.23 - 272.17) \text{ kJ/kg} - (20 + 273.15 \text{ K})(0.39424 - 1.0918) \text{ kJ/kg}\cdot\text{K} = \mathbf{40.55 \text{ kJ/kg}} \end{aligned}$$

$$\begin{aligned} \psi_2 &= h_2 - h_0 - T_0(s_2 - s_0) \\ &= (108.23 - 272.17) \text{ kJ/kg} - (20 + 273.15 \text{ K})(0.42271 - 1.0918) \text{ kJ/kg}\cdot\text{K} = 32.20 \text{ kJ/kg} \end{aligned}$$

(b) The exergy destruction is determined to be

$$x_{\text{dest}} = T_0(s_2 - s_1) = (20 + 273.15 \text{ K})(0.42271 - 0.39424) \text{ kJ/kg}\cdot\text{K} = \mathbf{8.34 \text{ kJ/kg}}$$

(c) The second-law efficiency for this process may be determined from

$$\eta_{\text{II}} = \frac{\psi_2}{\psi_1} = \frac{32.20 \text{ kJ/kg}}{40.55 \text{ kJ/kg}} = \mathbf{0.794}$$

**8-97** Steam is accelerated in an adiabatic nozzle. The exit velocity, the rate of exergy destruction, and the second-law efficiency are to be determined.

**Assumptions** 1 Steady operating conditions exist. 2 Potential energy changes are negligible.

**Analysis** (a) The properties of the steam at the inlet and exit of the turbine and at the dead state are (Tables A-4 through A-6)

$$\begin{aligned} P_1 = 3.5 \text{ MPa} & \left. \begin{array}{l} h_1 = 2978.4 \text{ kJ/kg} \\ T_1 = 300^\circ\text{C} \end{array} \right\} \begin{array}{l} s_1 = 6.4484 \text{ kJ/kg}\cdot\text{K} \\ P_2 = 1.6 \text{ kPa} \end{array} \left. \begin{array}{l} h_2 = 2919.9 \text{ kJ/kg} \\ T_2 = 250^\circ\text{C} \end{array} \right\} \begin{array}{l} s_2 = 6.6753 \text{ kJ/kg}\cdot\text{K} \\ T_0 = 18^\circ\text{C} \end{array} \left. \begin{array}{l} h_0 = 75.54 \text{ kJ/kg} \\ x = 0 \end{array} \right\} \begin{array}{l} s_0 = 0.2678 \text{ kJ/kg}\cdot\text{K} \end{array} \end{aligned}$$

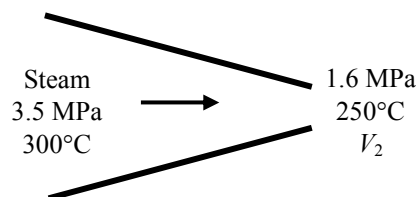

The exit velocity is determined from an energy balance on the nozzle

$$\begin{aligned} h_1 + \frac{V_1^2}{2} &= h_2 + \frac{V_2^2}{2} \\ 2978.4 \text{ kJ/kg} + \frac{(0 \text{ m/s})^2}{2} \left( \frac{1 \text{ kJ/kg}}{1000 \text{ m}^2/\text{s}^2} \right) &= 2919.9 \text{ kJ/kg} + \frac{V_2^2}{2} \left( \frac{1 \text{ kJ/kg}}{1000 \text{ m}^2/\text{s}^2} \right) \\ V_2 &= \mathbf{342.0 \text{ m/s}} \end{aligned}$$

(b) The rate of exergy destruction is the exergy decrease of the steam in the nozzle

$$\begin{aligned} \dot{X}_{\text{dest}} &= \dot{m} \left[ h_2 - h_1 + \frac{V_2^2 - V_1^2}{2} - T_0(s_2 - s_1) \right] \\ &= (0.4 \text{ kg/s}) \left[ (2919.9 - 2978.4) \text{ kJ/kg} + \frac{(342 \text{ m/s})^2 - 0}{2} \left( \frac{1 \text{ kJ/kg}}{1000 \text{ m}^2/\text{s}^2} \right) \right. \\ &\quad \left. - (291 \text{ K})(6.6753 - 6.4484) \text{ kJ/kg}\cdot\text{K} \right] \\ &= \mathbf{26.41 \text{ kW}} \end{aligned}$$

(c) The exergy of the refrigerant at the inlet is

$$\begin{aligned} \dot{X}_1 &= \dot{m} \left[ h_1 - h_0 + \frac{V_1^2}{2} - T_0(s_1 - s_0) \right] \\ &= (0.4 \text{ kg/s}) [(2978.4 - 75.54) \text{ kJ/kg} + 0 - (291 \text{ K})(6.4484 - 0.2678) \text{ kJ/kg}\cdot\text{K}] \\ &= 441.72 \text{ kW} \end{aligned}$$

The second-law efficiency for this device may be defined as the exergy output divided by the exergy input:

$$\eta_{\text{II}} = \frac{\dot{X}_2}{\dot{X}_1} = 1 - \frac{\dot{X}_{\text{dest}}}{\dot{X}_1} = 1 - \frac{26.41 \text{ kW}}{441.72 \text{ kW}} = \mathbf{0.940}$$

**8-98** R-134a is expanded in an adiabatic process with an isentropic efficiency of 0.85. The second law efficiency is to be determined.

**Assumptions 1** Kinetic and potential energy changes are negligible. **2** The device is adiabatic and thus heat transfer is negligible.

**Analysis** We take the R-134a as the system. This is a closed system since no mass enters or leaves. The energy balance for this stationary closed system can be expressed as

$$\underbrace{E_{\text{in}} - E_{\text{out}}}_{\text{Net energy transfer by heat, work, and mass}} = \underbrace{\Delta E_{\text{system}}}_{\text{Change in internal, kinetic, potential, etc. energies}}$$

$$-W_{\text{out}} = \Delta U = m(u_2 - u_1)$$

From the R-134a tables (Tables A-11 through A-13),

$$\left. \begin{array}{l} P_1 = 1600 \text{ kPa} \\ T_1 = 80^\circ\text{C} \end{array} \right\} \begin{array}{l} v_1 = 0.014362 \text{ m}^3/\text{kg} \\ u_1 = 282.09 \text{ kJ/kg} \\ s_1 = 0.9875 \text{ kJ/kg} \cdot \text{K} \end{array}$$

$$\left. \begin{array}{l} P_2 = 100 \text{ kPa} \\ s_{2s} = s_1 \end{array} \right\} u_{2s} = 223.16 \text{ kJ/kg}$$

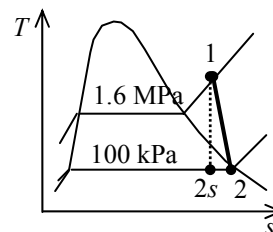

The actual work input is

$$w_{a,\text{out}} = \eta_T w_{s,\text{out}} = \eta_T (u_1 - u_{2s}) = (0.85)(282.09 - 223.16) \text{ kJ/kg} = 50.09 \text{ kJ/kg}$$

The actual internal energy at the end of the expansion process is

$$w_{a,\text{out}} = (u_1 - u_2) \longrightarrow u_2 = u_1 - w_{a,\text{out}} = 282.09 - 50.09 = 232.00 \text{ kJ/kg}$$

Other actual properties at the final state are (Table A-13)

$$\left. \begin{array}{l} P_2 = 100 \text{ kPa} \\ u_2 = 232.00 \text{ kJ/kg} \end{array} \right\} \begin{array}{l} v_2 = 0.2139 \text{ m}^3/\text{lbm} \\ s_2 = 1.0251 \text{ kJ/kg} \cdot \text{K} \end{array}$$

The useful work is determined from

$$\begin{aligned} w_u &= w_{a,\text{out}} - w_{\text{surr}} = w_{a,\text{out}} - P_0(v_2 - v_1) \\ &= 50.09 \text{ kJ/kg} - (100 \text{ kPa})(0.2139 - 0.014362) \text{ m}^3/\text{kg} \left( \frac{1 \text{ kJ}}{1 \text{ kPa} \cdot \text{m}^3} \right) \\ &= 30.14 \text{ kJ/kg} \end{aligned}$$

The exergy change between initial and final states is

$$\begin{aligned} \phi_1 - \phi_2 &= u_1 - u_2 + P_0(v_1 - v_2) - T_0(s_1 - s_2) \\ &= (282.09 - 232.00) \text{ kJ/kg} + (100 \text{ kPa})(0.014362 - 0.2139) \text{ m}^3/\text{kg} \left( \frac{1 \text{ kJ}}{1 \text{ kPa} \cdot \text{m}^3} \right) \\ &\quad - (298 \text{ K})(0.9875 - 1.0251) \text{ kJ/kg} \cdot \text{K} \\ &= 41.34 \text{ kJ/kg} \end{aligned}$$

The second law efficiency is then

$$\eta_{\text{II}} = \frac{w_u}{\Delta \phi} = \frac{30.14 \text{ kJ/kg}}{41.34 \text{ kJ/kg}} = \mathbf{0.729}$$



**8-99** Steam is condensed in a closed system at a constant pressure from a saturated vapor to a saturated liquid by rejecting heat to a thermal energy reservoir. The second law efficiency is to be determined.

**Assumptions 1** Kinetic and potential energy changes are negligible.

**Analysis** We take the steam as the system. This is a closed system since no mass enters or leaves. The energy balance for this stationary closed system can be expressed as

$$\underbrace{E_{\text{in}} - E_{\text{out}}}_{\substack{\text{Net energy transfer} \\ \text{by heat, work, and mass}}} = \underbrace{\Delta E_{\text{system}}}_{\substack{\text{Change in internal, kinetic,} \\ \text{potential, etc. energies}}}$$

$$W_{b,\text{in}} - Q_{\text{out}} = \Delta U = m(u_2 - u_1)$$

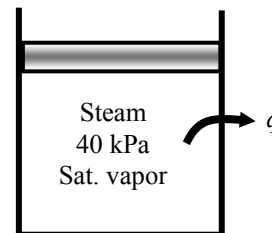

From the steam tables (Table A-5),

$$\left. \begin{array}{l} P_1 = 40 \text{ kPa} \\ \text{Sat. vapor} \end{array} \right\} \begin{array}{l} \nu_1 = \nu_g = 3.9933 \text{ m}^3/\text{kg} \\ u_1 = u_g = 2476.3 \text{ kJ/kg} \\ s_1 = s_g = 7.6691 \text{ kJ/kg} \cdot \text{K} \end{array}$$

$$\left. \begin{array}{l} P_2 = 40 \text{ kPa} \\ \text{Sat. liquid} \end{array} \right\} \begin{array}{l} \nu_2 = \nu_f = 0.001026 \text{ m}^3/\text{kg} \\ u_2 = u_f = 317.58 \text{ kJ/kg} \\ s_2 = s_f = 1.0261 \text{ kJ/kg} \cdot \text{K} \end{array}$$

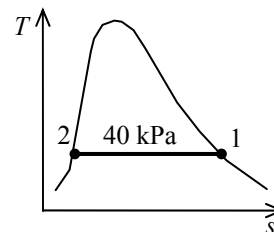

The boundary work during this process is

$$w_{b,\text{in}} = P(\nu_1 - \nu_2) = (40 \text{ kPa})(3.9933 - 0.001026) \text{ m}^3/\text{kg} \left( \frac{1 \text{ kJ}}{1 \text{ kPa} \cdot \text{m}^3} \right) = 159.7 \text{ kJ/kg}$$

The heat transfer is determined from the energy balance:

$$q_{\text{out}} = w_{b,\text{in}} - (u_2 - u_1) = 159.7 \text{ kJ/kg} - (317.58 - 2476.3) \text{ kJ/kg} = 2318.4 \text{ kJ/kg}$$

The exergy change between initial and final states is

$$\begin{aligned} \phi_1 - \phi_2 &= u_1 - u_2 + P_0(\nu_1 - \nu_2) - T_0(s_1 - s_2) - q_{\text{out}} \left( 1 - \frac{T_0}{T_R} \right) \\ &= (2476.3 - 317.58) \text{ kJ/kg} + (100 \text{ kPa})(3.9933 - 0.001026) \text{ m}^3/\text{kg} \left( \frac{1 \text{ kJ}}{1 \text{ kPa} \cdot \text{m}^3} \right) \\ &\quad - (298 \text{ K})(7.6691 - 1.0261) \text{ kJ/kg} \cdot \text{K} - (2318.4 \text{ kJ/kg}) \left( 1 - \frac{298 \text{ K}}{303 \text{ K}} \right) \\ &= 540.1 \text{ kJ/kg} \end{aligned}$$

The second law efficiency is then

$$\eta_{\text{II}} = \frac{w_{b,\text{in}}}{\Delta \phi} = \frac{159.7 \text{ kJ/kg}}{540.1 \text{ kJ/kg}} = \mathbf{0.296}$$

**8-100** R-134a is vaporized in a closed system at a constant pressure from a saturated liquid to a saturated vapor by transferring heat from a reservoir at two pressures. The pressure that is more effective from a second-law point of view is to be determined.

**Assumptions 1** Kinetic and potential energy changes are negligible.

**Analysis** We take the R-134a as the system. This is a closed system since no mass enters or leaves. The energy balance for this stationary closed system can be expressed as

$$\underbrace{E_{\text{in}} - E_{\text{out}}}_{\text{Net energy transfer by heat, work, and mass}} = \underbrace{\Delta E_{\text{system}}}_{\text{Change in internal, kinetic, potential, etc. energies}}$$

$$Q_{\text{in}} - W_{b,\text{out}} = \Delta U = m(u_2 - u_1)$$

$$Q_{\text{in}} = W_{b,\text{out}} + \Delta U$$

$$Q_{\text{in}} = \Delta H = m(h_2 - h_1)$$

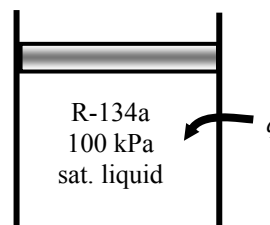

**At 100 kPa:**

From the R-134a tables (Table A-12),

$$u_{fg@100 \text{ kPa}} = 197.98 \text{ kJ/kg}$$

$$h_{fg@100 \text{ kPa}} = 217.16 \text{ kJ/kg}$$

$$s_{fg@100 \text{ kPa}} = 0.87995 \text{ kJ/kg} \cdot \text{K}$$

$$\nu_{fg@100 \text{ kPa}} = \nu_g - \nu_f = 0.19254 - 0.0007259 = 0.19181 \text{ m}^3/\text{kg}$$

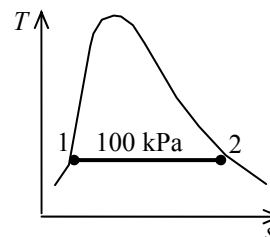

The boundary work during this process is

$$w_{b,\text{out}} = P(\nu_2 - \nu_1) = P\nu_{fg} = (100 \text{ kPa})(0.19181 \text{ m}^3/\text{kg}) \left( \frac{1 \text{ kJ}}{1 \text{ kPa} \cdot \text{m}^3} \right) = 19.18 \text{ kJ/kg}$$

The useful work is determined from

$$w_u = w_{b,\text{out}} - w_{\text{surr}} = P(\nu_2 - \nu_1) - P_0(\nu_2 - \nu_1) = 0 \text{ kJ/kg}$$

since  $P = P_0 = 100 \text{ kPa}$ . The heat transfer from the energy balance is

$$q_{\text{in}} = h_{fg} = 217.16 \text{ kJ/kg}$$

The exergy change between initial and final states is

$$\begin{aligned} \phi_1 - \phi_2 &= u_1 - u_2 + P_0(\nu_1 - \nu_2) - T_0(s_1 - s_2) + q_{\text{in}} \left( 1 - \frac{T_0}{T_R} \right) \\ &= -u_{fg} - P_0\nu_{fg} + T_0s_{fg} + q_{\text{in}} \left( 1 - \frac{T_0}{T_R} \right) \\ &= -197.98 \text{ kJ/kg} - (100 \text{ kPa})(0.19181 \text{ m}^3/\text{kg}) \left( \frac{1 \text{ kJ}}{1 \text{ kPa} \cdot \text{m}^3} \right) + (298 \text{ K})(0.87995 \text{ kJ/kg} \cdot \text{K}) \\ &\quad + (217.16 \text{ kJ/kg}) \left( 1 - \frac{298 \text{ K}}{273 \text{ K}} \right) \\ &= 25.18 \text{ kJ/kg} \end{aligned}$$

The second law efficiency is then

$$\eta_{\text{II}} = \frac{w_u}{\Delta\phi} = \frac{0 \text{ kJ/kg}}{25.18 \text{ kJ/kg}} = 0$$

**At 200 kPa:**

$$u_{fg @ 200 \text{ kPa}} = 186.21 \text{ kJ/kg}$$

$$h_{fg @ 200 \text{ kPa}} = 206.03 \text{ kJ/kg}$$

$$s_{fg @ 200 \text{ kPa}} = 0.78316 \text{ kJ/kg} \cdot \text{K}$$

$$\nu_{fg @ 200 \text{ kPa}} = \nu_g - \nu_f = 0.099867 - 0.0007533 = 0.099114 \text{ m}^3/\text{kg}$$

$$w_{b,\text{out}} = P(\nu_2 - \nu_1) = P\nu_{fg} = (200 \text{ kPa})(0.099114) \text{ m}^3/\text{kg} \left( \frac{1 \text{ kJ}}{1 \text{ kPa} \cdot \text{m}^3} \right) = 19.82 \text{ kJ/kg}$$

$$w_u = w_{b,\text{out}} - w_{\text{surr}} = P(\nu_2 - \nu_1) - P_0(\nu_2 - \nu_1)$$

$$= (P - P_0)\nu_{fg} = (200 - 100) \text{ kPa}(0.099114) \text{ m}^3/\text{kg} \left( \frac{1 \text{ kJ}}{1 \text{ kPa} \cdot \text{m}^3} \right) = 9.911 \text{ kJ/kg}$$

$$q_{\text{in}} = h_{fg} = 206.03 \text{ kJ/kg}$$

$$\phi_1 - \phi_2 = u_1 - u_2 + P_0(\nu_1 - \nu_2) - T_0(s_1 - s_2) + q_{\text{in}} \left( 1 - \frac{T_0}{T_R} \right)$$

$$= -u_{fg} - P_0\nu_{fg} + T_0s_{fg} + q_{\text{in}} \left( 1 - \frac{T_0}{T_R} \right)$$

$$= -186.21 \text{ kJ/kg} - (100 \text{ kPa})(0.099114 \text{ m}^3/\text{kg}) \left( \frac{1 \text{ kJ}}{1 \text{ kPa} \cdot \text{m}^3} \right) + (298 \text{ K})(0.78316 \text{ kJ/kg} \cdot \text{K})$$

$$+ (206.03 \text{ kJ/kg}) \left( 1 - \frac{298 \text{ K}}{273 \text{ K}} \right)$$

$$= 18.39 \text{ kJ/kg}$$

$$\eta_{\text{II}} = \frac{w_u}{\Delta\phi} = \frac{9.911 \text{ kJ/kg}}{18.39 \text{ kJ/kg}} = \mathbf{0.539}$$

The process at 200 kPa is more effective from a work production standpoint.

**8-101E** Steam is expanded in a two-stage turbine. Six percent of the inlet steam is bled for feedwater heating. The isentropic efficiencies for the two stages of the turbine are given. The second-law efficiency of the turbine is to be determined.

**Assumptions 1** This is a steady-flow process since there is no change with time. **2** The turbine is well-insulated, and there is no heat transfer from the turbine.

**Analysis** There is one inlet and two exits. We take the turbine as the system, which is a control volume since mass crosses the boundary. The energy balance for this steady-flow system can be expressed in the rate form as

$$\underbrace{\dot{E}_{\text{in}} - \dot{E}_{\text{out}}}_{\text{Rate of net energy transfer by heat, work, and mass}} = \underbrace{\Delta \dot{E}_{\text{system}}}_{\text{Rate of change in internal, kinetic, potential, etc. energies}} \stackrel{\text{no (steady)}}{=} 0$$

$$\begin{aligned} \dot{E}_{\text{in}} &= \dot{E}_{\text{out}} \\ \dot{m}_1 h_1 &= \dot{m}_2 h_2 + \dot{m}_3 h_3 + \dot{W}_{\text{out}} \\ \dot{W}_{\text{out}} &= \dot{m}_1 h_1 - \dot{m}_2 h_2 - \dot{m}_3 h_3 \\ w_{\text{out}} &= h_1 - 0.06h_2 - 0.94h_3 \\ w_{\text{out}} &= (h_1 - h_2) + 0.94(h_2 - h_3) \end{aligned}$$

The isentropic and actual enthalpies at three states are determined using steam tables as follows:

$$\left. \begin{array}{l} P_1 = 500 \text{ psia} \\ T_1 = 600^\circ\text{F} \end{array} \right\} \begin{array}{l} h_1 = 1298.6 \text{ Btu/lbm} \\ s_1 = 1.5590 \text{ Btu/lbm} \cdot \text{R} \end{array}$$

$$\left. \begin{array}{l} P_2 = 100 \text{ psia} \\ s_{2s} = s_1 = 1.5590 \text{ Btu/lbm} \cdot \text{R} \end{array} \right\} \begin{array}{l} x_{2s} = 0.9609 \\ h_{2s} = 1152.7 \text{ Btu/lbm} \end{array}$$

$$\eta_{T,1} = \frac{h_1 - h_2}{h_1 - h_{2s}} \longrightarrow h_2 = h_1 - \eta_{T,1}(h_1 - h_{2s}) = 1298.6 - (0.97)(1298.6 - 1152.7) = 1157.1 \text{ kJ/kg}$$

$$\left. \begin{array}{l} P_2 = 100 \text{ psia} \\ h_2 = 1157.1 \text{ Btu/lbm} \end{array} \right\} \begin{array}{l} x_2 = 0.9658 \\ s_2 = 1.5646 \text{ Btu/lbm} \cdot \text{R} \end{array}$$

$$\left. \begin{array}{l} P_3 = 5 \text{ psia} \\ s_3 = s_2 = 1.5646 \text{ kJ/kg} \cdot \text{K} \end{array} \right\} \begin{array}{l} x_{3s} = 0.8265 \\ h_{3s} = 957.09 \text{ Btu/lbm} \end{array}$$

$$\eta_{T,2} = \frac{h_2 - h_3}{h_2 - h_{3s}} \longrightarrow h_3 = h_2 - \eta_{T,2}(h_2 - h_{3s}) = 1157.1 - (0.95)(1157.1 - 957.09) = 967.09 \text{ kJ/kg}$$

$$\left. \begin{array}{l} P_3 = 5 \text{ psia} \\ h_3 = 967.09 \text{ Btu/lbm} \end{array} \right\} \begin{array}{l} x_3 = 0.8364 \\ s_3 = 1.5807 \text{ Btu/lbm} \cdot \text{R} \end{array}$$

Substituting into the energy balance per unit mass flow at the inlet of the turbine, we obtain

$$\begin{aligned} w_{\text{out}} &= (h_1 - h_2) + 0.94(h_2 - h_3) \\ &= (1298.6 - 1157.1) + 0.94(1157.1 - 967.09) = 320.1 \text{ Btu/lbm} \end{aligned}$$

The reversible work output per unit mass flow at the turbine inlet is

$$\begin{aligned} w_{\text{rev}} &= h_1 - h_2 - T_0(s_1 - s_2) + 0.94[h_2 - h_3 - T_0(s_2 - s_3)] \\ &= 1298.6 - 1157.1 - (537)(1.5590 - 1.5646) + 0.94[(1157.1 - 967.09) - (537)(1.5646 - 1.5807)] \\ &= 331.2 \text{ Btu/lbm} \end{aligned}$$

The second law efficiency is then

$$\eta_{\text{II}} = \frac{w_{\text{out}}}{w_{\text{rev}}} = \frac{320.1 \text{ Btu/lbm}}{331.2 \text{ Btu/lbm}} = \mathbf{0.966}$$

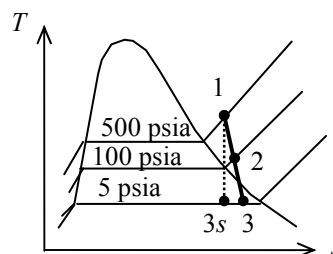
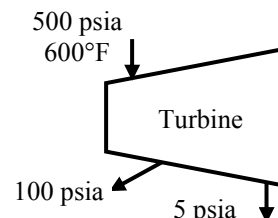

**8-102** An electrical radiator is placed in a room and it is turned on for a period of time. The time period for which the heater was on, the exergy destruction, and the second-law efficiency are to be determined.

**Assumptions 1** Kinetic and potential energy changes are negligible. **2** Air is an ideal gas with constant specific heats. **3** The room is well-sealed. **4** Standard atmospheric pressure of 101.3 kPa is assumed.

**Properties** The properties of air at room temperature are  $R = 0.287 \text{ kPa}\cdot\text{m}^3/\text{kg}\cdot\text{K}$ ,  $c_p = 1.005 \text{ kJ/kg}\cdot\text{K}$ ,  $c_v = 0.718 \text{ kJ/kg}\cdot\text{K}$  (Table A-2). The properties of oil are given to be  $\rho = 950 \text{ kg/m}^3$ ,  $c_{\text{oil}} = 2.2 \text{ kJ/kg}\cdot\text{K}$ .

**Analysis (a)** The masses of air and oil are

$$m_a = \frac{P_1 \mathcal{V}}{RT_1} = \frac{(101.3 \text{ kPa})(50 \text{ m}^3)}{(0.287 \text{ kPa}\cdot\text{m}^3/\text{kg}\cdot\text{K})(10 + 273 \text{ K})} = 62.36 \text{ kg}$$

$$m_{\text{oil}} = \rho_{\text{oil}} \mathcal{V}_{\text{oil}} = (950 \text{ kg/m}^3)(0.030 \text{ m}^3) = 28.50 \text{ kg}$$

An energy balance on the system can be used to determine time period for which the heater was kept on

$$\begin{aligned} (\dot{W}_{\text{in}} - \dot{Q}_{\text{out}}) \Delta t &= [m c_v (T_2 - T_1)]_a + [m c (T_2 - T_1)]_{\text{oil}} \\ (1.8 - 0.35 \text{ kW}) \Delta t &= [(62.36 \text{ kg})(0.718 \text{ kJ/kg}\cdot\text{K})(20 - 10)^\circ\text{C}] + [(28.50 \text{ kg})(2.2 \text{ kJ/kg}\cdot\text{K})(50 - 10)^\circ\text{C}] \\ \Delta t &= \mathbf{2038 \text{ s} = 34 \text{ min}} \end{aligned}$$

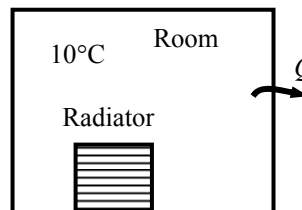

(b) The pressure of the air at the final state is

$$P_{a2} = \frac{m_a R T_{a2}}{\mathcal{V}} = \frac{(62.36 \text{ kg})(0.287 \text{ kPa}\cdot\text{m}^3/\text{kg}\cdot\text{K})(20 + 273 \text{ K})}{50 \text{ m}^3} = 104.9 \text{ kPa}$$

The amount of heat transfer to the surroundings is

$$Q_{\text{out}} = \dot{Q}_{\text{out}} \Delta t = (0.35 \text{ kJ/s})(2038 \text{ s}) = 713.5 \text{ kJ}$$

The entropy generation is the sum of the entropy changes of air, oil, and the surroundings

$$\begin{aligned} \Delta S_a &= m \left[ c_p \ln \frac{T_2}{T_1} - R \ln \frac{P_2}{P_1} \right] \\ &= (62.36 \text{ kg}) \left[ (1.005 \text{ kJ/kg}\cdot\text{K}) \ln \frac{(20 + 273) \text{ K}}{(10 + 273) \text{ K}} - (0.287 \text{ kJ/kg}\cdot\text{K}) \ln \frac{104.9 \text{ kPa}}{101.3 \text{ kPa}} \right] \\ &= 1.5548 \text{ kJ/K} \end{aligned}$$

$$\Delta S_{\text{oil}} = m c \ln \frac{T_2}{T_1} = (28.50 \text{ kg})(2.2 \text{ kJ/kg}\cdot\text{K}) \ln \frac{(50 + 273) \text{ K}}{(10 + 273) \text{ K}} = 8.2893 \text{ kJ/K}$$

$$\Delta S_{\text{surr}} = \frac{Q_{\text{out}}}{T_{\text{surr}}} = \frac{713.5 \text{ kJ}}{(10 + 273) \text{ K}} = 2.521 \text{ kJ/K}$$

$$S_{\text{gen}} = \Delta S_a + \Delta S_{\text{oil}} + \Delta S_{\text{surr}} = 1.5548 + 8.2893 + 2.521 = 12.365 \text{ kJ/K}$$

The exergy destruction is determined from

$$X_{\text{dest}} = T_0 S_{\text{gen}} = (10 + 273 \text{ K})(12.365 \text{ kJ/K}) = \mathbf{3500 \text{ kJ}}$$

(c) The second-law efficiency may be defined in this case as the ratio of the exergy recovered to the exergy input. That is,

$$\begin{aligned} X_{a,2} &= m [c_v (T_2 - T_1)] - T_0 \Delta S_a \\ &= (62.36 \text{ kg}) [(0.718 \text{ kJ/kg}\cdot\text{K})(20 - 10)^\circ\text{C}] - (10 + 273 \text{ K})(1.5548 \text{ kJ/K}) = 7.729 \text{ kJ} \end{aligned}$$

$$\begin{aligned} X_{\text{oil},2} &= m [C(T_2 - T_1)] - T_0 \Delta S_a \\ &= (28.50 \text{ kg}) [(2.2 \text{ kJ/kg}\cdot\text{K})(50 - 10)^\circ\text{C}] - (10 + 273 \text{ K})(8.2893 \text{ kJ/K}) = 162.13 \text{ kJ} \end{aligned}$$

$$\eta_{II} = \frac{X_{\text{recovered}}}{X_{\text{supplied}}} = \frac{X_{a,2} + X_{\text{oil},2}}{\dot{W}_{\text{in}} \Delta t} = \frac{(7.729 + 162.13) \text{ kJ}}{(1.8 \text{ kJ/s})(2038 \text{ s})} = \mathbf{0.046 = 4.6\%}$$

**8-103** Hot exhaust gases leaving an internal combustion engine is to be used to obtain saturated steam in an adiabatic heat exchanger. The rate at which the steam is obtained, the rate of exergy destruction, and the second-law efficiency are to be determined.

**Assumptions** 1 Steady operating conditions exist. 2 Kinetic and potential energy changes are negligible. 3 Air properties are used for exhaust gases. 4 Pressure drops in the heat exchanger are negligible.

**Properties** The gas constant of air is  $R = 0.287 \text{ kJ/kg}\cdot\text{K}$ . The specific heat of air at the average temperature of exhaust gases (650 K) is  $c_p = 1.063 \text{ kJ/kg}\cdot\text{K}$  (Table A-2).

**Analysis** (a) We denote the inlet and exit states of exhaust gases by (1) and (2) and that of the water by (3) and (4). The properties of water are (Table A-4)

$$\begin{aligned} T_3 = 20^\circ\text{C} & \left\{ \begin{array}{l} h_3 = 83.91 \text{ kJ/kg} \\ x_3 = 0 \end{array} \right. & \left. \begin{array}{l} s_3 = 0.29649 \text{ kJ/kg}\cdot\text{K} \\ \end{array} \right. \\ T_4 = 200^\circ\text{C} & \left\{ \begin{array}{l} h_4 = 2792.0 \text{ kJ/kg} \\ x_4 = 1 \end{array} \right. & \left. \begin{array}{l} s_4 = 6.4302 \text{ kJ/kg}\cdot\text{K} \\ \end{array} \right. \end{aligned}$$

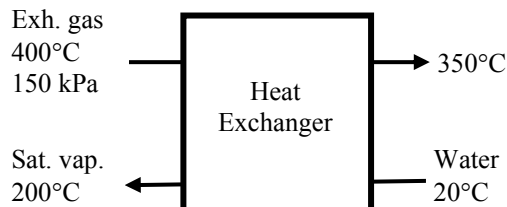

An energy balance on the heat exchanger gives

$$\begin{aligned} \dot{m}_a h_1 + \dot{m}_w h_3 &= \dot{m}_a h_2 + \dot{m}_w h_4 \\ \dot{m}_a c_p (T_1 - T_2) &= \dot{m}_w (h_4 - h_3) \\ (0.8 \text{ kg/s})(1.063 \text{ kJ/kg}\cdot^\circ\text{C})(400 - 350)^\circ\text{C} &= \dot{m}_w (2792.0 - 83.91) \text{ kJ/kg} \\ \dot{m}_w &= \mathbf{0.01570 \text{ kg/s}} \end{aligned}$$

(b) The specific exergy changes of each stream as it flows in the heat exchanger is

$$\Delta s_a = c_p \ln \frac{T_2}{T_1} = (0.8 \text{ kg/s})(1.063 \text{ kJ/kg}\cdot\text{K}) \ln \frac{(350 + 273) \text{ K}}{(400 + 273) \text{ K}} = -0.08206 \text{ kJ/kg}\cdot\text{K}$$

$$\begin{aligned} \Delta \psi_a &= c_p (T_2 - T_1) - T_0 \Delta s_a \\ &= (1.063 \text{ kJ/kg}\cdot^\circ\text{C})(350 - 400)^\circ\text{C} - (20 + 273 \text{ K})(-0.08206 \text{ kJ/kg}\cdot\text{K}) \\ &= -29.106 \text{ kJ/kg} \end{aligned}$$

$$\begin{aligned} \Delta \psi_w &= h_4 - h_3 - T_0 (s_4 - s_3) \\ &= (2792.0 - 83.91) \text{ kJ/kg} - (20 + 273 \text{ K})(6.4302 - 0.29649) \text{ kJ/kg}\cdot\text{K} \\ &= 910.913 \text{ kJ/kg} \end{aligned}$$

The exergy destruction is determined from an exergy balance on the heat exchanger to be

$$-\dot{X}_{\text{dest}} = \dot{m}_a \Delta \psi_a + \dot{m}_w \Delta \psi_w = (0.8 \text{ kg/s})(-29.106 \text{ kJ/kg}) + (0.01570 \text{ kg/s})(910.913 \text{ kJ/kg}) = -8.98 \text{ kW}$$

or

$$\dot{X}_{\text{dest}} = \mathbf{8.98 \text{ kW}}$$

(c) The second-law efficiency for a heat exchanger may be defined as the exergy increase of the cold fluid divided by the exergy decrease of the hot fluid. That is,

$$\eta_{\text{II}} = \frac{\dot{m}_w \Delta \psi_w}{-\dot{m}_a \Delta \psi_a} = \frac{(0.01570 \text{ kg/s})(910.913 \text{ kJ/kg})}{-(0.8 \text{ kg/s})(-29.106 \text{ kJ/kg})} = \mathbf{0.614}$$

**8-104** The inner and outer surfaces of a window glass are maintained at specified temperatures. The amount of heat loss and the amount of exergy destruction in 5 h are to be determined

**Assumptions** Steady operating conditions exist since the surface temperatures of the glass remain constant at the specified values.

**Analysis** We take the glass to be the system, which is a closed system. The amount of heat loss is determined from

$$Q = \dot{Q}\Delta t = (4.4 \text{ kJ/s})(5 \times 3600 \text{ s}) = \mathbf{79,200 \text{ kJ}}$$

Under steady conditions, the rate form of the entropy balance for the glass simplifies to

$$\underbrace{\dot{S}_{\text{in}} - \dot{S}_{\text{out}}}_{\text{Rate of net entropy transfer by heat and mass}} + \underbrace{\dot{S}_{\text{gen}}}_{\text{Rate of entropy generation}} = \underbrace{\Delta\dot{S}_{\text{system}}}_{\text{Rate of change of entropy}} \stackrel{\neq 0}{=} 0$$

$$\frac{\dot{Q}_{\text{in}}}{T_{\text{b,in}}} - \frac{\dot{Q}_{\text{out}}}{T_{\text{b,out}}} + \dot{S}_{\text{gen,glass}} = 0$$

$$\frac{4400 \text{ W}}{283 \text{ K}} - \frac{4400 \text{ W}}{276 \text{ K}} + \dot{S}_{\text{gen,glass}} = 0 \rightarrow \dot{S}_{\text{gen,glass}} = 0.3943 \text{ W/K}$$

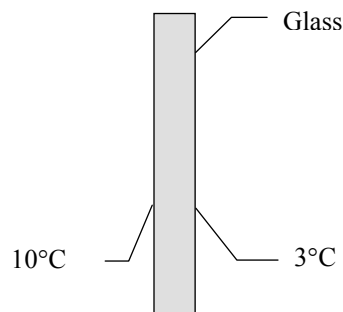

Then the amount of entropy generation over a period of 5 h becomes

$$S_{\text{gen,glass}} = \dot{S}_{\text{gen,glass}}\Delta t = (0.3943 \text{ W/K})(5 \times 3600 \text{ s}) = 7098 \text{ J/K}$$

The exergy destroyed during a process can be determined from an exergy balance or directly from its definition  $X_{\text{destroyed}} = T_0 S_{\text{gen}}$ ,

$$X_{\text{destroyed}} = T_0 S_{\text{gen}} = (278 \text{ K})(7.098 \text{ kJ/K}) = \mathbf{1973 \text{ kJ}}$$

**Discussion** The total entropy generated during this process can be determined by applying the entropy balance on an *extended system* that includes the glass and its immediate surroundings on both sides so that the boundary temperature of the extended system is the room temperature on one side and the environment temperature on the other side at all times. Using this value of entropy generation will give the total exergy destroyed during the process, including the temperature gradient zones on both sides of the window.

**8-105** Heat is transferred steadily to boiling water in the pan through its bottom. The inner and outer surface temperatures of the bottom of the pan are given. The rate of exergy destruction within the bottom plate is to be determined.

**Assumptions** Steady operating conditions exist since the surface temperatures of the pan remain constant at the specified values.

**Analysis** We take the bottom of the pan to be the system, which is a closed system. Under steady conditions, the rate form of the entropy balance for this system can be expressed as

$$\underbrace{\dot{S}_{in} - \dot{S}_{out}}_{\text{Rate of net entropy transfer by heat and mass}} + \underbrace{\dot{S}_{gen}}_{\text{Rate of entropy generation}} = \underbrace{\Delta\dot{S}_{system}}_{\text{Rate of change of entropy}} \overset{\phi^0}{=} 0$$

$$\frac{\dot{Q}_{in}}{T_{b,in}} - \frac{\dot{Q}_{out}}{T_{b,out}} + \dot{S}_{gen,system} = 0$$

$$\frac{800 \text{ W}}{378 \text{ K}} - \frac{800 \text{ W}}{377 \text{ K}} + \dot{S}_{gen,system} = 0$$

$$\dot{S}_{gen,system} = 0.00561 \text{ W/K}$$

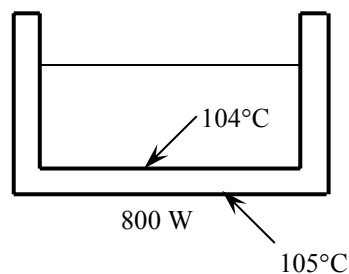

The exergy destroyed during a process can be determined from an exergy balance or directly from its definition  $\dot{X}_{destroyed} = T_0 \dot{S}_{gen}$ ,

$$\dot{X}_{destroyed} = T_0 \dot{S}_{gen} = (298 \text{ K})(0.00561 \text{ W/K}) = \mathbf{1.67 \text{ W}}$$

**8-106** A elevation, base area, and the depth of a crater lake are given. The maximum amount of electricity that can be generated by a hydroelectric power plant is to be determined.

**Assumptions** The evaporation of water from the lake is negligible.

**Analysis** The exergy or work potential of the water is the potential energy it possesses relative to the ground level,

$$\text{Exergy} = PE = mgh$$

Therefore,

$$\begin{aligned} \text{Exergy} = PE &= \int dPE = \int gz dm = \int gz(\rho A dz) \\ &= \rho Ag \int_{z_1}^{z_2} z dz = \rho Ag(z_2^2 - z_1^2)/2 \\ &= 0.5(1000 \text{ kg/m}^3)(2 \times 10^4 \text{ m}^2)(9.81 \text{ m/s}^2) \\ &\quad \times ((152 \text{ m})^2 - (140 \text{ m})^2) \left( \frac{1 \text{ h}}{3600 \text{ s}} \right) \left( \frac{1 \text{ kJ/kg}}{1000 \text{ m}^2/\text{s}^2} \right) \\ &= \mathbf{9.55 \times 10^4 \text{ kWh}} \end{aligned}$$

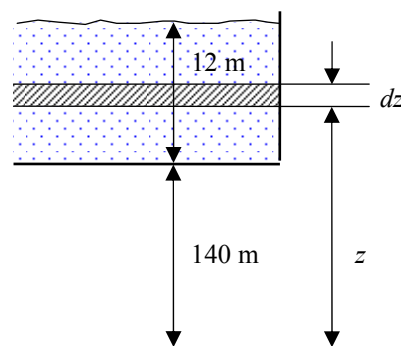



**8-107E** The 2<sup>nd</sup>-law efficiency of a refrigerator and the refrigeration rate are given. The power input to the refrigerator is to be determined.

**Analysis** From the definition of the second law efficiency, the COP of the refrigerator is determined to be

$$\text{COP}_{R,\text{rev}} = \frac{1}{T_H/T_L - 1} = \frac{1}{535/495 - 1} = 12.375$$

$$\eta_{II} = \frac{\text{COP}_R}{\text{COP}_{R,\text{rev}}} \longrightarrow \text{COP}_R = \eta_{II} \text{COP}_{R,\text{rev}} = 0.45 \times 12.375 = 5.57$$

Thus the power input is

$$\dot{W}_{\text{in}} = \frac{\dot{Q}_L}{\text{COP}_R} = \frac{200 \text{ Btu/min}}{5.57} \left( \frac{1 \text{ hp}}{42.41 \text{ Btu/min}} \right) = \mathbf{0.85 \text{ hp}}$$

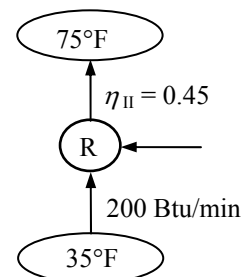

**8-108** Writing energy and entropy balances, a relation for the reversible work is to be obtained for a closed system that exchanges heat with surroundings at  $T_0$  in the amount of  $Q_0$  as well as a heat reservoir at temperature  $T_R$  in the amount  $Q_R$ .

**Assumptions** Kinetic and potential changes are negligible.

**Analysis** We take the direction of heat transfers to be to the system (heat input) and the direction of work transfer to be from the system (work output). The result obtained is still general since quantities with opposite directions can be handled the same way by using negative signs. The energy and entropy balances for this stationary closed system can be expressed as

$$\text{Energy balance: } E_{\text{in}} - E_{\text{out}} = \Delta E_{\text{system}} \rightarrow Q_0 + Q_R - W = U_2 - U_1 \longrightarrow W = U_1 - U_2 + Q_0 + Q_R \quad (1)$$

$$\text{Entropy balance: } S_{\text{in}} - S_{\text{out}} + S_{\text{gen}} = \Delta S_{\text{system}} \rightarrow S_{\text{gen}} = (S_2 - S_1) + \frac{-Q_R}{T_R} + \frac{-Q_0}{T_0} \quad (2)$$

Solving for  $Q_0$  from (2) and substituting in (1) yields

$$W = (U_1 - U_2) - T_0(S_1 - S_2) - Q_R \left( 1 - \frac{T_0}{T_R} \right) - T_0 S_{\text{gen}}$$

The useful work relation for a closed system is obtained from

$$W_u = W - W_{\text{surr}}$$

$$= (U_1 - U_2) - T_0(S_1 - S_2) - Q_R \left( 1 - \frac{T_0}{T_R} \right) - T_0 S_{\text{gen}} - P_0(\mathbf{v}_2 - \mathbf{v}_1)$$

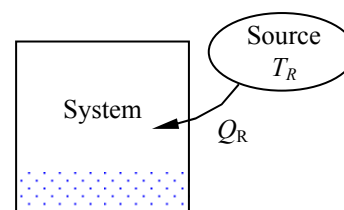

Then the reversible work relation is obtained by substituting  $S_{\text{gen}} = 0$ ,

$$W_{\text{rev}} = (U_1 - U_2) - T_0(S_1 - S_2) + P_0(\mathbf{v}_1 - \mathbf{v}_2) - Q_R \left( 1 - \frac{T_0}{T_R} \right)$$

A positive result for  $W_{\text{rev}}$  indicates work output, and a negative result work input. Also, the  $Q_R$  is a positive quantity for heat transfer to the system, and a negative quantity for heat transfer from the system.

**8-109** Writing energy and entropy balances, a relation for the reversible work is to be obtained for a steady-flow system that exchanges heat with surroundings at  $T_0$  at a rate of  $\dot{Q}_0$  as well as a heat reservoir at temperature  $T_R$  in the amount  $\dot{Q}_R$ .

**Analysis** We take the direction of heat transfers to be to the system (heat input) and the direction of work transfer to be from the system (work output). The result obtained is still general since quantities with opposite directions can be handled the same way by using negative signs. The energy and entropy balances for this stationary closed system can be expressed as

Energy balance:  $\dot{E}_{\text{in}} - \dot{E}_{\text{out}} = \Delta \dot{E}_{\text{system}} \rightarrow \dot{E}_{\text{in}} = \dot{E}_{\text{out}}$

$$\dot{Q}_0 + \dot{Q}_R - \dot{W} = \sum \dot{m}_e \left( h_e + \frac{V_e^2}{2} + gz_e \right) - \sum \dot{m}_i \left( h_i + \frac{V_i^2}{2} + gz_i \right)$$

or 
$$\dot{W} = \sum \dot{m}_i \left( h_i + \frac{V_i^2}{2} + gz_i \right) - \sum \dot{m}_e \left( h_e + \frac{V_e^2}{2} + gz_e \right) + \dot{Q}_0 + \dot{Q}_R \quad (1)$$

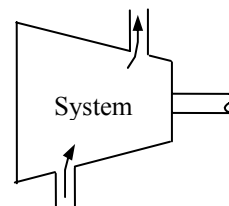

Entropy balance:

$$\dot{S}_{\text{in}} - \dot{S}_{\text{out}} + \dot{S}_{\text{gen}} = \Delta \dot{S}_{\text{system}} = 0$$

$$\dot{S}_{\text{gen}} = \dot{S}_{\text{out}} - \dot{S}_{\text{in}}$$

$$\dot{S}_{\text{gen}} = \sum \dot{m}_e s_e - \sum \dot{m}_i s_i + \frac{-\dot{Q}_R}{T_R} + \frac{-\dot{Q}_0}{T_0} \quad (2)$$

Solving for  $\dot{Q}_0$  from (2) and substituting in (1) yields

$$\dot{W} = \sum \dot{m}_i \left( h_i + \frac{V_i^2}{2} + gz_i - T_0 s_i \right) - \sum \dot{m}_e \left( h_e + \frac{V_e^2}{2} + gz_e - T_0 s_e \right) - T_0 \dot{S}_{\text{gen}} - \dot{Q}_R \left( 1 - \frac{T_0}{T_R} \right)$$

Then the reversible work relation is obtained by substituting  $S_{\text{gen}} = 0$ ,

$$\dot{W}_{\text{rev}} = \sum \dot{m}_i \left( h_i + \frac{V_i^2}{2} + gz_i - T_0 s_i \right) - \sum \dot{m}_e \left( h_e + \frac{V_e^2}{2} + gz_e - T_0 s_e \right) - \dot{Q}_R \left( 1 - \frac{T_0}{T_R} \right)$$

A positive result for  $W_{\text{rev}}$  indicates work output, and a negative result work input. Also, the  $Q_R$  is a positive quantity for heat transfer to the system, and a negative quantity for heat transfer from the system.

**8-110** Writing energy and entropy balances, a relation for the reversible work is to be obtained for a uniform-flow system that exchanges heat with surroundings at  $T_0$  in the amount of  $Q_0$  as well as a heat reservoir at temperature  $T_R$  in the amount  $Q_R$ .

**Assumptions** Kinetic and potential changes are negligible.

**Analysis** We take the direction of heat transfers to be to the system (heat input) and the direction of work transfer to be from the system (work output). The result obtained is still general since quantities with opposite directions can be handled the same way by using negative signs. The energy and entropy balances for this stationary closed system can be expressed as

Energy balance:  $E_{\text{in}} - E_{\text{out}} = \Delta E_{\text{system}}$

$$Q_0 + Q_R - W = \sum m_e \left( h_e + \frac{V_e^2}{2} + gz_e \right) - \sum m_i \left( h_i + \frac{V_i^2}{2} + gz_i \right) + (U_2 - U_1)_{\text{cv}}$$

or, 
$$W = \sum m_i \left( h_i + \frac{V_i^2}{2} + gz_i \right) - \sum m_e \left( h_e + \frac{V_e^2}{2} + gz_e \right) - (U_2 - U_1)_{\text{cv}} + Q_0 + Q_R \quad (1)$$

Entropy balance:  $S_{\text{in}} - S_{\text{out}} + S_{\text{gen}} = \Delta S_{\text{system}}$

$$S_{\text{gen}} = (S_2 - S_1)_{\text{cv}} + \sum m_e s_e - \sum m_i s_i + \frac{-Q_R}{T_R} + \frac{-Q_0}{T_0} \quad (2)$$

Solving for  $Q_0$  from (2) and substituting in (1) yields

$$W = \sum m_i \left( h_i + \frac{V_i^2}{2} + gz_i - T_0 s_i \right) - \sum m_e \left( h_e + \frac{V_e^2}{2} + gz_e - T_0 s_e \right) + [(U_1 - U_2) - T_0 (S_1 - S_2)]_{\text{cv}} - T_0 S_{\text{gen}} - Q_R \left( 1 - \frac{T_0}{T_R} \right)$$

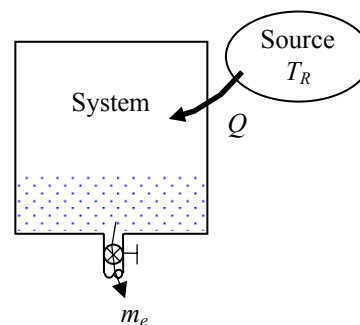

The useful work relation for a closed system is obtained from

$$W_u = W - W_{\text{surr}} = \sum m_i \left( h_i + \frac{V_i^2}{2} + gz_i - T_0 s_i \right) - \sum m_e \left( h_e + \frac{V_e^2}{2} + gz_e - T_0 s_e \right) + [(U_1 - U_2) - T_0 (S_1 - S_2)]_{\text{cv}} - T_0 S_{\text{gen}} - Q_R \left( 1 - \frac{T_0}{T_R} \right) - P_0 (\mathcal{V}_2 - \mathcal{V}_1)$$

Then the reversible work relation is obtained by substituting  $S_{\text{gen}} = 0$ ,

$$W_{\text{rev}} = \sum m_i \left( h_i + \frac{V_i^2}{2} + gz_i - T_0 s_i \right) - \sum m_e \left( h_e + \frac{V_e^2}{2} + gz_e - T_0 s_e \right) + [(U_1 - U_2) - T_0 (S_1 - S_2) + P_0 (\mathcal{V}_1 - \mathcal{V}_2)]_{\text{cv}} - Q_R \left( 1 - \frac{T_0}{T_R} \right)$$

A positive result for  $W_{\text{rev}}$  indicates work output, and a negative result work input. Also, the  $Q_R$  is a positive quantity for heat transfer to the system, and a negative quantity for heat transfer from the system.

**8-111** An electric resistance heater is immersed in water. The time it will take for the electric heater to raise the water temperature to a specified temperature, the minimum work input, and the exergy destroyed during this process are to be determined.

**Assumptions** **1** Water is an incompressible substance with constant specific heats. **2** The energy stored in the container itself and the heater is negligible. **3** Heat loss from the container is negligible. **4** The environment temperature is given to be  $T_0 = 20^\circ\text{C}$ .

**Properties** The specific heat of water at room temperature is  $c = 4.18 \text{ kJ/kg}\cdot^\circ\text{C}$  (Table A-3).

**Analysis** Taking the water in the container as the system, which is a closed system, the energy balance can be expressed as

$$\underbrace{E_{\text{in}} - E_{\text{out}}}_{\substack{\text{Net energy transfer} \\ \text{by heat, work, and mass}}} = \underbrace{\Delta E_{\text{system}}}_{\substack{\text{Change in internal, kinetic,} \\ \text{potential, etc. energies}}}$$

$$W_{\text{e,in}} = (\Delta U)_{\text{water}}$$

$$\dot{W}_{\text{e,in}} \Delta t = mc(T_2 - T_1)_{\text{water}}$$

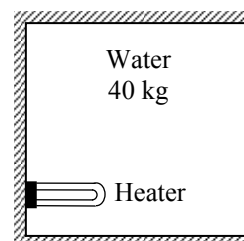

Substituting,

$$(800 \text{ J/s})\Delta t = (40 \text{ kg})(4180 \text{ J/kg}\cdot^\circ\text{C})(80 - 20)^\circ\text{C}$$

Solving for  $\Delta t$  gives

$$\Delta t = \mathbf{12,544 \text{ s} = 209.1 \text{ min} = 3.484 \text{ h}}$$

Again we take the water in the tank to be the system. Noting that no heat or mass crosses the boundaries of this system and the energy and entropy contents of the heater are negligible, the entropy balance for it can be expressed as

$$\underbrace{S_{\text{in}} - S_{\text{out}}}_{\substack{\text{Net entropy transfer} \\ \text{by heat and mass}}} + \underbrace{S_{\text{gen}}}_{\substack{\text{Entropy} \\ \text{generation}}} = \underbrace{\Delta S_{\text{system}}}_{\substack{\text{Change} \\ \text{in entropy}}}$$

$$0 + S_{\text{gen}} = \Delta S_{\text{water}}$$

Therefore, the entropy generated during this process is

$$S_{\text{gen}} = \Delta S_{\text{water}} = mc \ln \frac{T_2}{T_1} = (40 \text{ kg})(4.184 \text{ kJ/kg}\cdot\text{K}) \ln \frac{353 \text{ K}}{293 \text{ K}} = \mathbf{31.18 \text{ kJ/K}}$$

The exergy destroyed during a process can be determined from an exergy balance or directly from its definition  $X_{\text{destroyed}} = T_0 S_{\text{gen}}$ ,

$$X_{\text{destroyed}} = T_0 S_{\text{gen}} = (293 \text{ K})(31.18 \text{ kJ/K}) = \mathbf{9136 \text{ kJ}}$$

The actual work input for this process is

$$W_{\text{act,in}} = \dot{W}_{\text{act,in}} \Delta t = (0.8 \text{ kJ/s})(12,552 \text{ s}) = 10,042 \text{ kJ}$$

Then the reversible (or minimum required) work input becomes

$$W_{\text{rev,in}} = W_{\text{act,in}} - X_{\text{destroyed}} = 10,042 - 9136 = \mathbf{906 \text{ kJ}}$$

**8-112** A hot water pipe at a specified temperature is losing heat to the surrounding air at a specified rate. The rate at which the work potential is wasted during this process is to be determined.

**Assumptions** Steady operating conditions exist.

**Analysis** We take the air in the vicinity of the pipe (excluding the pipe) as our system, which is a closed system. The system extends from the outer surface of the pipe to a distance at which the temperature drops to the surroundings temperature. In steady operation, the rate form of the entropy balance for this system can be expressed as

$$\underbrace{\dot{S}_{\text{in}} - \dot{S}_{\text{out}}}_{\text{Rate of net entropy transfer by heat and mass}} + \underbrace{\dot{S}_{\text{gen}}}_{\text{Rate of entropy generation}} = \underbrace{\Delta\dot{S}_{\text{system}}}_{\text{Rate of change of entropy}} \stackrel{\neq 0}{=} 0$$

$$\frac{\dot{Q}_{\text{in}}}{T_{\text{b,in}}} - \frac{\dot{Q}_{\text{out}}}{T_{\text{b,out}}} + \dot{S}_{\text{gen,system}} = 0$$

$$\frac{1175 \text{ W}}{353 \text{ K}} - \frac{1175 \text{ W}}{278 \text{ K}} + \dot{S}_{\text{gen,system}} = 0 \rightarrow \dot{S}_{\text{gen,system}} = 0.8980 \text{ W/K}$$

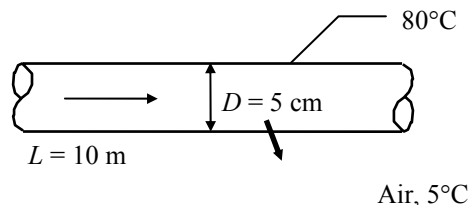

The exergy destroyed during a process can be determined from an exergy balance or directly from its definition  $\dot{X}_{\text{destroyed}} = T_0 \dot{S}_{\text{gen}}$ ,

$$\dot{X}_{\text{destroyed}} = T_0 \dot{S}_{\text{gen}} = (278 \text{ K})(0.8980 \text{ W/K}) = \mathbf{250 \text{ W}}$$

**8-113** Air expands in an adiabatic turbine from a specified state to another specified state. The second-law efficiency is to be determined.

**Assumptions 1** This is a steady-flow process since there is no change with time. **2** The device is adiabatic and thus heat transfer is negligible. **3** Air is an ideal gas with constant specific heats. **4** Kinetic and potential energy changes are negligible.

**Properties** At the average temperature of  $(425 + 325)/2 = 375$  K, the constant pressure specific heat of air is  $c_p = 1.011$  kJ/kg·K (Table A-2b). The gas constant of air is  $R = 0.287$  kJ/kg·K (Table A-1).

**Analysis** There is only one inlet and one exit, and thus  $\dot{m}_1 = \dot{m}_2 = \dot{m}$ . We take the turbine as the system, which is a control volume since mass crosses the boundary. The energy balance for this steady-flow system can be expressed in the rate form as

$$\underbrace{\dot{E}_{\text{in}} - \dot{E}_{\text{out}}}_{\text{Rate of net energy transfer by heat, work, and mass}} = \underbrace{\Delta \dot{E}_{\text{system}}}_{\text{Rate of change in internal, kinetic, potential, etc. energies}} \stackrel{\text{no (steady)}}{=} 0$$

$$\dot{E}_{\text{in}} = \dot{E}_{\text{out}}$$

$$\dot{m}h_1 = \dot{W}_{\text{out}} + \dot{m}h_2$$

$$\dot{W}_{\text{out}} = \dot{m}(h_1 - h_2)$$

$$w_{\text{out}} = c_p(T_1 - T_2)$$

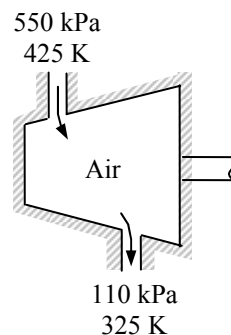

Substituting,

$$w_{\text{out}} = c_p(T_1 - T_2) = (1.011 \text{ kJ/kg} \cdot \text{K})(425 - 325)\text{K} = 101.1 \text{ kJ/kg}$$

The entropy change of air is

$$s_2 - s_1 = c_p \ln \frac{T_2}{T_1} - R \ln \frac{P_2}{P_1}$$

$$= (1.011 \text{ kJ/kg} \cdot \text{K}) \ln \frac{325 \text{ K}}{425 \text{ K}} - (0.287 \text{ kJ/kg} \cdot \text{K}) \ln \frac{110 \text{ kPa}}{550 \text{ kPa}}$$

$$= 0.1907 \text{ kJ/kg} \cdot \text{K}$$

The maximum (reversible) work is the exergy difference between the inlet and exit states

$$w_{\text{rev,out}} = c_p(T_1 - T_2) - T_0(s_1 - s_2)$$

$$= w_{\text{out}} - T_0(s_1 - s_2)$$

$$= 101.1 \text{ kJ/kg} - (298 \text{ K})(-0.1907 \text{ kJ/kg} \cdot \text{K})$$

$$= \mathbf{157.9 \text{ kJ/kg}}$$

The second law efficiency is then

$$\eta_{\text{II}} = \frac{w_{\text{out}}}{w_{\text{rev,out}}} = \frac{101.1 \text{ kJ/kg}}{157.9 \text{ kJ/kg}} = \mathbf{0.640}$$

**8-114** Steam is accelerated in a nozzle. The actual and maximum outlet velocities are to be determined.

**Assumptions 1** The nozzle operates steadily. **2** The changes in potential energies are negligible.

**Properties** The properties of steam at the inlet and the exit of the nozzle are (Tables A-4 through A-6)

$$\left. \begin{array}{l} P_1 = 500 \text{ kPa} \\ T_1 = 200^\circ\text{C} \end{array} \right\} \begin{array}{l} h_1 = 2855.8 \text{ kJ/kg} \\ s_1 = 7.0610 \text{ kJ/kg}\cdot\text{K} \end{array}$$

$$\left. \begin{array}{l} P_2 = 200 \text{ kPa} \\ x_2 = 1 \text{ (sat. vapor)} \end{array} \right\} \begin{array}{l} h_2 = 2706.3 \text{ kJ/kg} \\ s_2 = 7.1270 \text{ kJ/kg}\cdot\text{K} \end{array}$$

**Analysis** We take the nozzle to be the system, which is a control volume. The energy balance for this steady-flow system can be expressed in the rate form as

$$\underbrace{\dot{E}_{\text{in}} - \dot{E}_{\text{out}}}_{\substack{\text{Rate of net energy transfer} \\ \text{by heat, work, and mass}}} = \underbrace{\Delta\dot{E}_{\text{system}}}_{\substack{\text{Rate of change in internal, kinetic,} \\ \text{potential, etc. energies}}} \overset{\neq 0 \text{ (steady)}}{=} 0$$

$$\dot{E}_{\text{in}} = \dot{E}_{\text{out}}$$

$$\dot{m}(h_1 + V_1^2/2) = \dot{m}(h_2 + V_2^2/2)$$

$$\frac{V_2^2 - V_1^2}{2} = h_1 - h_2 = \Delta\text{ke}_{\text{actual}}$$

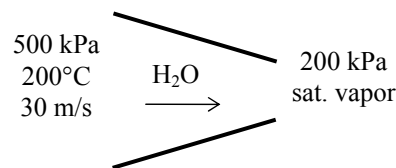

Substituting,

$$\Delta\text{ke}_{\text{actual}} = h_1 - h_2 = 2855.8 - 2706.3 = 149.5 \text{ kJ/kg}$$

The actual velocity at the exit is then

$$\frac{V_2^2 - V_1^2}{2} = \Delta\text{ke}_{\text{actual}}$$

$$V_2 = \sqrt{V_1^2 + 2\Delta\text{ke}_{\text{actual}}} = \sqrt{(30 \text{ m/s})^2 + 2(149.5 \text{ kJ/kg})\left(\frac{1000 \text{ m}^2/\text{s}^2}{1 \text{ kJ/kg}}\right)} = \mathbf{547.6 \text{ m/s}}$$

The maximum kinetic energy change is determined from

$$\Delta\text{ke}_{\text{max}} = h_1 - h_2 - T_0(s_1 - s_2) = 2855.8 - 2706.3 - (298)(7.0610 - 7.1270) = 169.2 \text{ kJ/kg}$$

The maximum velocity at the exit is then

$$\frac{V_{2,\text{max}}^2 - V_1^2}{2} = \Delta\text{ke}_{\text{max}}$$

$$V_{2,\text{max}} = \sqrt{V_1^2 + 2\Delta\text{ke}_{\text{max}}} = \sqrt{(30 \text{ m/s})^2 + 2(169.2 \text{ kJ/kg})\left(\frac{1000 \text{ m}^2/\text{s}^2}{1 \text{ kJ/kg}}\right)}$$

$$= \mathbf{582.5 \text{ m/s}}$$

**8-115** A throttle valve is placed in the steam line supplying the turbine inlet in order to control an isentropic steam turbine. The second-law efficiency of this system when the valve is partially open to when it is fully open is to be compared.

**Assumptions 1** This is a steady-flow process since there is no change with time. **2** The turbine is well-insulated, and there is no heat transfer from the turbine.

**Analysis**

**Valve is fully open:**

The properties of steam at various states are

$$\left. \begin{array}{l} P_1 = P_2 = 6 \text{ MPa} \\ T_1 = T_2 = 700^\circ\text{C} \end{array} \right\} \begin{array}{l} h_1 = h_2 = 3894.3 \text{ kJ/kg} \\ s_1 = s_2 = 7.4247 \text{ kJ/kg}\cdot\text{K} \end{array}$$

$$\left. \begin{array}{l} P_3 = 70 \text{ kPa} \\ s_2 = s_1 \end{array} \right\} \begin{array}{l} x_3 = 0.9914 \\ h_3 = 2639.7 \text{ kJ/kg} \end{array}$$

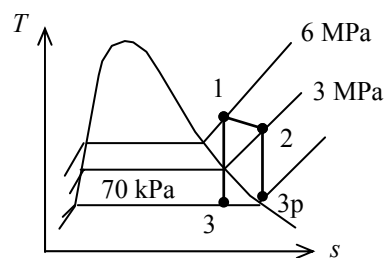

The second law efficiency of the entire system is then

$$\eta_{\text{II}} = \frac{w_{\text{out}}}{w_{\text{rev}}} = \frac{h_1 - h_3}{h_1 - h_3 - T_0(s_1 - s_3)} = \frac{h_1 - h_3}{h_1 - h_3} = \mathbf{1.0}$$

since  $s_1 = s_3$  for this system.

**Valve is partly open:**

$$\left. \begin{array}{l} P_2 = 3 \text{ MPa} \\ h_2 = h_1 = 3894.3 \text{ kJ/kg} \end{array} \right\} s_2 = 7.7405 \text{ kJ/kg}\cdot\text{K} \quad (\text{from EES})$$

$$\left. \begin{array}{l} P_3 = 70 \text{ kPa} \\ s_3 = s_2 \end{array} \right\} h_3 = 2760.8 \text{ kJ/kg} \quad (\text{from EES})$$

$$\eta_{\text{II}} = \frac{w_{\text{out}}}{w_{\text{rev}}} = \frac{h_1 - h_3}{h_1 - h_3 - T_0(s_1 - s_3)} = \frac{3894.3 - 2760.8}{3894.3 - 2760.8 - (298)(7.4247 - 7.7405)} = \mathbf{0.923}$$



**8-116** Two rigid tanks that contain water at different states are connected by a valve. The valve is opened and steam flows from tank A to tank B until the pressure in tank A drops to a specified value. Tank B loses heat to the surroundings. The final temperature in each tank and the work potential wasted during this process are to be determined.

**Assumptions** **1** Tank A is insulated and thus heat transfer is negligible. **2** The water that remains in tank A undergoes a reversible adiabatic process. **3** The thermal energy stored in the tanks themselves is negligible. **4** The system is stationary and thus kinetic and potential energy changes are negligible. **5** There are no work interactions.

**Analysis** (a) The steam in tank A undergoes a reversible, adiabatic process, and thus  $s_2 = s_1$ . From the steam tables (Tables A-4 through A-6),

**Tank A :**

$$P_1 = 400 \text{ kPa} \quad \left. \begin{array}{l} \nu_{1,A} = \nu_f + x_1 \nu_{fg} = 0.001084 + (0.8)(0.46242 - 0.001084) = 0.37015 \text{ m}^3/\text{kg} \\ u_{1,A} = u_f + x_1 u_{fg} = 604.22 + (0.8)(1948.9) = 2163.3 \text{ kJ/kg} \\ x_1 = 0.8 \end{array} \right\} \begin{array}{l} s_{1,A} = s_f + x_1 s_{fg} = 1.7765 + (0.8)(5.1191) = 5.8717 \text{ kJ/kg} \cdot \text{K} \end{array}$$

$$T_{2,A} = T_{\text{sat}@300 \text{ kPa}} = \mathbf{133.52^\circ\text{C}}$$

$$P_2 = 300 \text{ kPa} \quad \left. \begin{array}{l} x_{2,A} = \frac{s_{2,A} - s_f}{s_{fg}} = \frac{5.8717 - 1.6717}{5.3200} = 0.7895 \\ \nu_{2,A} = \nu_f + x_{2,A} \nu_{fg} = 0.001073 + (0.7895)(0.60582 - 0.001073) = 0.47850 \text{ m}^3/\text{kg} \\ u_{2,A} = u_f + x_{2,A} u_{fg} = 561.11 + (0.7895)(1982.1 \text{ kJ/kg}) = 2125.9 \text{ kJ/kg} \end{array} \right\} \begin{array}{l} s_2 = s_1 \\ \text{(sat. mixture)} \end{array}$$

**Tank B :**

$$P_1 = 200 \text{ kPa} \quad \left. \begin{array}{l} \nu_{1,B} = 1.1989 \text{ m}^3/\text{kg} \\ u_{1,B} = 2731.4 \text{ kJ/kg} \\ T_1 = 250^\circ\text{C} \end{array} \right\} \begin{array}{l} s_{1,B} = 7.7100 \text{ kJ/kg} \cdot \text{K} \end{array}$$

The initial and the final masses in tank A are

$$m_{1,A} = \frac{\nu_A}{\nu_{1,A}} = \frac{0.2 \text{ m}^3}{0.37015 \text{ m}^3/\text{kg}} = 0.5403 \text{ kg}$$

and

$$m_{2,A} = \frac{\nu_A}{\nu_{2,A}} = \frac{0.2 \text{ m}^3}{0.479 \text{ m}^3/\text{kg}} = 0.4180 \text{ kg}$$

Thus,  $0.540 - 0.418 = 0.122 \text{ kg}$  of mass flows into tank B. Then,

$$m_{2,B} = m_{1,B} - 0.122 = 3 + 0.122 = 3.122 \text{ kg}$$

The final specific volume of steam in tank B is determined from

$$\nu_{2,B} = \frac{\nu_B}{m_{2,B}} = \frac{(m_1 \nu_1)_B}{m_{2,B}} = \frac{(3 \text{ kg})(1.1989 \text{ m}^3/\text{kg})}{3.122 \text{ m}^3} = 1.152 \text{ m}^3/\text{kg}$$

We take the entire contents of both tanks as the system, which is a closed system. The energy balance for this stationary closed system can be expressed as

$$\underbrace{E_{\text{in}} - E_{\text{out}}}_{\text{Net energy transfer by heat, work, and mass}} = \underbrace{\Delta E_{\text{system}}}_{\text{Change in internal, kinetic, potential, etc. energies}}$$

$$-Q_{\text{out}} = \Delta U = (\Delta U)_A + (\Delta U)_B \quad (\text{since } W = \text{KE} = \text{PE} = 0)$$

$$-Q_{\text{out}} = (m_2 u_2 - m_1 u_1)_A + (m_2 u_2 - m_1 u_1)_B$$

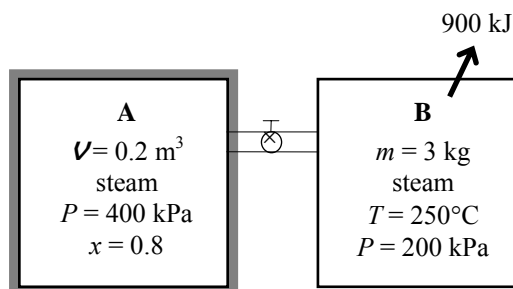

Substituting,

$$-900 = \{(0.418)(2125.9) - (0.5403)(2163.3)\} + \{(3.122)u_{2,B} - (3)(2731.4)\}$$

$$u_{2,B} = 2425.9 \text{ kJ/kg}$$

Thus,

$$\left. \begin{aligned} v_{2,B} &= 1.152 \text{ m}^3/\text{kg} \\ u_{2,B} &= 2425.9 \text{ kJ/kg} \end{aligned} \right\} \begin{aligned} T_{2,B} &= \mathbf{110.1^\circ\text{C}} \\ s_{2,B} &= 6.9772 \text{ kJ/kg}\cdot\text{K} \end{aligned}$$

(b) The total entropy generation during this process is determined by applying the entropy balance on an *extended system* that includes both tanks and their immediate surroundings so that the boundary temperature of the extended system is the temperature of the surroundings at all times. It gives

$$\underbrace{S_{\text{in}} - S_{\text{out}}}_{\substack{\text{Net entropy transfer} \\ \text{by heat and mass}}} + \underbrace{S_{\text{gen}}}_{\substack{\text{Entropy} \\ \text{generation}}} = \underbrace{\Delta S_{\text{system}}}_{\substack{\text{Change} \\ \text{in entropy}}}$$

$$-\frac{Q_{\text{out}}}{T_{\text{b,surr}}} + S_{\text{gen}} = \Delta S_A + \Delta S_B$$

Rearranging and substituting, the total entropy generated during this process is determined to be

$$S_{\text{gen}} = \Delta S_A + \Delta S_B + \frac{Q_{\text{out}}}{T_{\text{b,surr}}} = (m_2 s_2 - m_1 s_1)_A + (m_2 s_2 - m_1 s_1)_B + \frac{Q_{\text{out}}}{T_{\text{b,surr}}}$$

$$= \{(0.418)(5.8717) - (0.5403)(5.8717)\} + \{(3.122)(6.9772) - (3)(7.7100)\} + \frac{900 \text{ kJ}}{273 \text{ K}}$$

$$= 1.234 \text{ kJ/K}$$

The work potential wasted is equivalent to the exergy destroyed during a process, which can be determined from an exergy balance or directly from its definition  $X_{\text{destroyed}} = T_0 S_{\text{gen}}$ ,

$$X_{\text{destroyed}} = T_0 S_{\text{gen}} = (273 \text{ K})(1.234 \text{ kJ/K}) = \mathbf{337 \text{ kJ}}$$

**8-117E** A cylinder initially filled with helium gas at a specified state is compressed polytropically to a specified temperature and pressure. The actual work consumed and the minimum useful work input needed are to be determined.

**Assumptions 1** Helium is an ideal gas with constant specific heats. **2** The cylinder is stationary and thus the kinetic and potential energy changes are negligible. **3** The thermal energy stored in the cylinder itself is negligible. **4** The compression or expansion process is quasi-equilibrium. **5** The environment temperature is 70°F.

**Properties** The gas constant of helium is  $R = 2.6805 \text{ psia}\cdot\text{ft}^3/\text{lbm}\cdot\text{R} = 0.4961 \text{ Btu}/\text{lbm}\cdot\text{R}$  (Table A-1E). The specific heats of helium are  $c_v = 0.753$  and  $c_p = 1.25 \text{ Btu}/\text{lbm}\cdot\text{R}$  (Table A-2E).

**Analysis** (a) Helium at specified conditions can be treated as an ideal gas. The mass of helium is

$$m = \frac{P_1 V_1}{RT_1} = \frac{(25 \text{ psia})(15 \text{ ft}^3)}{(2.6805 \text{ psia}\cdot\text{ft}^3/\text{lbm}\cdot\text{R})(530 \text{ R})} = 0.264 \text{ lbm}$$

The exponent  $n$  and the boundary work for this polytropic process are determined to be

$$\frac{P_1 V_1}{T_1} = \frac{P_2 V_2}{T_2} \longrightarrow V_2 = \frac{T_2}{T_1} \frac{P_1}{P_2} V_1 = \frac{(760 \text{ R})(25 \text{ psia})}{(530 \text{ R})(70 \text{ psia})} (15 \text{ ft}^3) = 7.682 \text{ ft}^3$$

$$P_2 V_2^n = P_1 V_1^n \longrightarrow \left(\frac{P_2}{P_1}\right) = \left(\frac{V_1}{V_2}\right)^n \longrightarrow \left(\frac{70}{25}\right) = \left(\frac{15}{7.682}\right)^n \longrightarrow n = 1.539$$

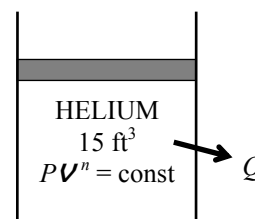

Then the boundary work for this polytropic process can be determined from

$$\begin{aligned} W_{b,\text{in}} &= -\int_1^2 P dV = -\frac{P_2 V_2 - P_1 V_1}{1-n} = -\frac{mR(T_2 - T_1)}{1-n} \\ &= -\frac{(0.264 \text{ lbm})(0.4961 \text{ Btu}/\text{lbm}\cdot\text{R})(760 - 530)\text{R}}{1-1.539} = 55.9 \text{ Btu} \end{aligned}$$

Also,

$$W_{\text{surr},\text{in}} = -P_0 (V_2 - V_1) = -(14.7 \text{ psia})(7.682 - 15)\text{ft}^3 \left(\frac{1 \text{ Btu}}{5.4039 \text{ psia}\cdot\text{ft}^3}\right) = 19.9 \text{ Btu}$$

Thus,

$$W_{u,\text{in}} = W_{b,\text{in}} - W_{\text{surr},\text{in}} = 55.9 - 19.9 = \mathbf{36.0 \text{ Btu}}$$

(b) We take the helium in the cylinder as the system, which is a closed system. Taking the direction of heat transfer to be from the cylinder, the energy balance for this stationary closed system can be expressed as

$$\begin{aligned} \underbrace{E_{\text{in}} - E_{\text{out}}}_{\text{Net energy transfer by heat, work, and mass}} &= \underbrace{\Delta E_{\text{system}}}_{\text{Change in internal, kinetic, potential, etc. energies}} \\ -Q_{\text{out}} + W_{b,\text{in}} &= \Delta U = m(u_2 - u_1) \\ -Q_{\text{out}} &= m(u_2 - u_1) - W_{b,\text{in}} \\ Q_{\text{out}} &= W_{b,\text{in}} - mc_v(T_2 - T_1) \end{aligned}$$

Substituting,

$$Q_{\text{out}} = 55.9 \text{ Btu} - (0.264 \text{ lbm})(0.753 \text{ Btu}/\text{lbm}\cdot\text{R})(760 - 530)\text{R} = 10.2 \text{ Btu}$$

The total entropy generation during this process is determined by applying the entropy balance on an *extended system* that includes the cylinder and its immediate surroundings so that the boundary temperature of the extended system is the temperature of the surroundings at all times. It gives

$$\underbrace{S_{\text{in}} - S_{\text{out}}}_{\substack{\text{Net entropy transfer} \\ \text{by heat and mass}}} + \underbrace{S_{\text{gen}}}_{\substack{\text{Entropy} \\ \text{generation}}} = \underbrace{\Delta S_{\text{system}}}_{\substack{\text{Change} \\ \text{in entropy}}}$$

$$-\frac{Q_{\text{out}}}{T_{\text{b,surr}}} + S_{\text{gen}} = \Delta S_{\text{sys}}$$

where the entropy change of helium is

$$\begin{aligned} \Delta S_{\text{sys}} = \Delta S_{\text{helium}} &= m \left( c_{p,\text{avg}} \ln \frac{T_2}{T_1} - R \ln \frac{P_2}{P_1} \right) \\ &= (0.264 \text{ lbm}) \left[ (1.25 \text{ Btu/lbm} \cdot \text{R}) \ln \frac{760 \text{ R}}{530 \text{ R}} - (0.4961 \text{ Btu/lbm} \cdot \text{R}) \ln \frac{70 \text{ psia}}{25 \text{ psia}} \right] \\ &= -0.0159 \text{ Btu/R} \end{aligned}$$

Rearranging and substituting, the total entropy generated during this process is determined to be

$$S_{\text{gen}} = \Delta S_{\text{helium}} + \frac{Q_{\text{out}}}{T_0} = (-0.0159 \text{ Btu/R}) + \frac{10.2 \text{ Btu}}{530 \text{ R}} = 0.003345 \text{ Btu/R}$$

The work potential wasted is equivalent to the exergy destroyed during a process, which can be determined from an exergy balance or directly from its definition  $X_{\text{destroyed}} = T_0 S_{\text{gen}}$ ,

$$X_{\text{destroyed}} = T_0 S_{\text{gen}} = (530 \text{ R})(0.003345 \text{ Btu/R}) = 1.77 \text{ Btu}$$

The minimum work with which this process could be accomplished is the reversible work input,  $W_{\text{rev,in}}$ , which can be determined directly from

$$W_{\text{rev,in}} = W_{\text{act,in}} - X_{\text{destroyed}} = 36.0 - 1.77 = \mathbf{34.23 \text{ Btu}}$$

**Discussion** The reversible work input, which represents the minimum work input  $W_{\text{rev,in}}$  in this case can be determined from the exergy balance by setting the exergy destruction term equal to zero,

$$\underbrace{X_{\text{in}} - X_{\text{out}}}_{\substack{\text{Net exergy transfer} \\ \text{by heat, work, and mass}}} - \underbrace{X_{\text{destroyed}}}_{\substack{\text{Exergy} \\ \text{destruction}}} \stackrel{\text{no (reversible)}}{=} \underbrace{\Delta X_{\text{system}}}_{\substack{\text{Change} \\ \text{in exergy}}} \rightarrow W_{\text{rev,in}} = X_2 - X_1$$

Substituting the closed system exergy relation, the reversible work input during this process is determined to be

$$\begin{aligned} W_{\text{rev}} &= (U_2 - U_1) - T_0 (S_2 - S_1) + P_0 (V_2 - V_1) \\ &= (0.264 \text{ lbm})(0.753 \text{ Btu/lbm} \cdot \text{R})(300 - 70)^\circ\text{F} - (530 \text{ R})(-0.0159 \text{ Btu/R}) \\ &\quad + (14.7 \text{ psia})(7.682 - 15) \text{ ft}^3 [\text{Btu}/5.4039 \text{ psia} \cdot \text{ft}^3] \\ &= \mathbf{34.24 \text{ Btu}} \end{aligned}$$

**8-118** Steam expands in a two-stage adiabatic turbine from a specified state to specified pressure. Some steam is extracted at the end of the first stage. The wasted power potential is to be determined.

**Assumptions 1** This is a steady-flow process since there is no change with time. **2** Kinetic and potential energy changes are negligible. **3** The turbine is adiabatic and thus heat transfer is negligible. **4** The environment temperature is given to be  $T_0 = 25^\circ\text{C}$ .

**Analysis** The wasted power potential is equivalent to the rate of exergy destruction during a process, which can be determined from an exergy balance or directly from its definition  $\dot{X}_{\text{destroyed}} = T_0 \dot{S}_{\text{gen}}$ .

The total rate of entropy generation during this process is determined by taking the entire turbine, which is a control volume, as the system and applying the entropy balance. Noting that this is a steady-flow process and there is no heat transfer,

$$\underbrace{\dot{S}_{\text{in}} - \dot{S}_{\text{out}}}_{\text{Rate of net entropy transfer by heat and mass}} + \underbrace{\dot{S}_{\text{gen}}}_{\text{Rate of entropy generation}} = \underbrace{\Delta \dot{S}_{\text{system}}^{\phi=0}}_{\text{Rate of change of entropy}} = 0$$

$$\dot{m}_1 s_1 - \dot{m}_2 s_2 - \dot{m}_3 s_3 + \dot{S}_{\text{gen}} = 0$$

$$\dot{m}_1 s_1 - 0.1 \dot{m}_1 s_2 - 0.9 \dot{m}_1 s_3 + \dot{S}_{\text{gen}} = 0 \rightarrow \dot{S}_{\text{gen}} = \dot{m}_1 [0.9 s_3 + 0.1 s_2 - s_1]$$

and  $\dot{X}_{\text{destroyed}} = T_0 \dot{S}_{\text{gen}} = T_0 \dot{m}_1 [0.9 s_3 + 0.1 s_2 - s_1]$

From the steam tables (Tables A-4 through 6)

$$\left. \begin{array}{l} P_1 = 9 \text{ MPa} \\ T_1 = 500^\circ\text{C} \end{array} \right\} \begin{array}{l} h_1 = 3387.4 \text{ kJ/kg} \\ s_1 = 6.6603 \text{ kJ/kg} \cdot \text{K} \end{array}$$

$$\left. \begin{array}{l} P_2 = 1.4 \text{ MPa} \\ s_{2s} = s_1 \end{array} \right\} h_{2s} = 2882.4 \text{ kJ/kg}$$

and,

$$\eta_T = \frac{h_1 - h_2}{h_1 - h_{2s}} \rightarrow h_2 = h_1 - \eta_T (h_1 - h_{2s})$$

$$= 3387.4 - 0.88(3387.4 - 2882.4)$$

$$= 2943.0 \text{ kJ/kg}$$

$$\left. \begin{array}{l} P_2 = 1.4 \text{ MPa} \\ h_2 = 2943.0 \text{ kJ/kg} \end{array} \right\} s_2 = 6.7776 \text{ kJ/kg} \cdot \text{K}$$

$$\left. \begin{array}{l} P_3 = 50 \text{ kPa} \\ s_{3s} = s_1 \end{array} \right\} \begin{array}{l} x_{3s} = \frac{s_{3s} - s_f}{s_{fg}} = \frac{6.6603 - 1.0912}{6.5019} = 0.8565 \\ h_{3s} = h_f + x_{3s} h_{fg} = 340.54 + 0.8565 \times 2304.7 = 2314.6 \text{ kJ/kg} \end{array}$$

and  $\eta_T = \frac{h_1 - h_3}{h_1 - h_{3s}} \rightarrow h_3 = h_1 - \eta_T (h_1 - h_{3s})$

$$= 3387.4 - 0.88(3387.4 - 2314.6)$$

$$= 2443.3 \text{ kJ/kg}$$

$$\left. \begin{array}{l} P_3 = 50 \text{ kPa} \\ h_3 = 2443.3 \text{ kJ/kg} \end{array} \right\} \begin{array}{l} x_3 = \frac{h_3 - h_f}{h_{fg}} = \frac{2443.3 - 340.54}{2304.7} = 0.9124 \\ s_3 = s_f + x_3 s_{fg} = 1.0912 + 0.9124 \times 6.5019 = 7.0235 \text{ kJ/kg} \cdot \text{K} \end{array}$$

Substituting, the wasted work potential is determined to be

$$\dot{X}_{\text{destroyed}} = T_0 \dot{S}_{\text{gen}} = (298 \text{ K})(15 \text{ kg/s})(0.9 \times 7.0235 + 0.1 \times 6.7776 - 6.6603) \text{ kJ/kg} = \mathbf{1514 \text{ kW}}$$

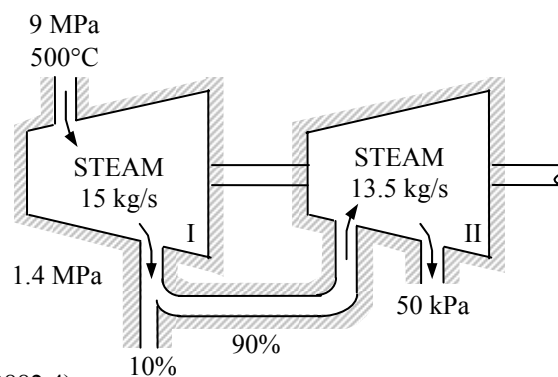

**8-119** Steam expands in a two-stage adiabatic turbine from a specified state to another specified state. Steam is reheated between the stages. For a given power output, the reversible power output and the rate of exergy destruction are to be determined.

**Assumptions** **1** This is a steady-flow process since there is no change with time. **2** Kinetic and potential energy changes are negligible. **3** The turbine is adiabatic and thus heat transfer is negligible. **4** The environment temperature is given to be  $T_0 = 25^\circ\text{C}$ .

**Properties** From the steam tables (Tables A-4 through 6)

$$\left. \begin{array}{l} P_1 = 8 \text{ MPa} \\ T_1 = 500^\circ\text{C} \end{array} \right\} \begin{array}{l} h_1 = 3399.5 \text{ kJ/kg} \\ s_1 = 6.7266 \text{ kJ/kg}\cdot\text{K} \end{array}$$

$$\left. \begin{array}{l} P_2 = 2 \text{ MPa} \\ T_2 = 350^\circ\text{C} \end{array} \right\} \begin{array}{l} h_2 = 3137.7 \text{ kJ/kg} \\ s_2 = 6.9583 \text{ kJ/kg}\cdot\text{K} \end{array}$$

$$\left. \begin{array}{l} P_3 = 2 \text{ MPa} \\ T_3 = 500^\circ\text{C} \end{array} \right\} \begin{array}{l} h_3 = 3468.3 \text{ kJ/kg} \\ s_3 = 7.4337 \text{ kJ/kg}\cdot\text{K} \end{array}$$

$$\left. \begin{array}{l} P_4 = 30 \text{ kPa} \\ x_4 = 0.97 \end{array} \right\} \begin{array}{l} h_4 = h_f + x_4 h_{fg} = 289.27 + 0.97 \times 2335.3 = 2554.5 \text{ kJ/kg} \\ s_4 = s_f + x_4 s_{fg} = 0.9441 + 0.97 \times 6.8234 = 7.5628 \text{ kJ/kg}\cdot\text{K} \end{array}$$

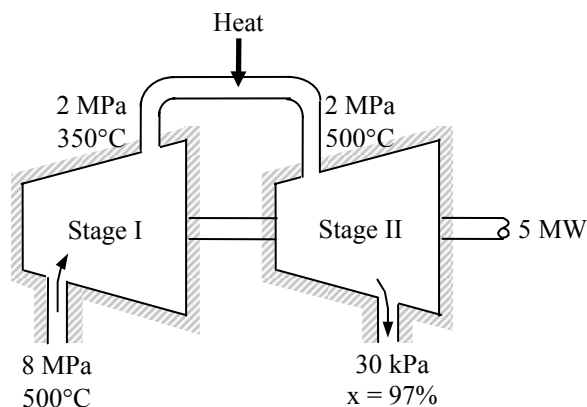

**Analysis** We take the entire turbine, excluding the reheat section, as the system, which is a control volume. The energy balance for this steady-flow system can be expressed in the rate form as

$$\underbrace{\dot{E}_{\text{in}} - \dot{E}_{\text{out}}}_{\text{Rate of net energy transfer by heat, work, and mass}} = \underbrace{\Delta \dot{E}_{\text{system}}}_{\text{Rate of change in internal, kinetic, potential, etc. energies}} \stackrel{\text{no (steady)}}{=} 0$$

$$\dot{E}_{\text{in}} = \dot{E}_{\text{out}}$$

$$\dot{m}h_1 + \dot{m}h_3 = \dot{m}h_2 + \dot{m}h_4 + \dot{W}_{\text{out}}$$

$$\dot{W}_{\text{out}} = \dot{m}[(h_1 - h_2) + (h_3 - h_4)]$$

Substituting, the mass flow rate of the steam is determined from the steady-flow energy equation applied to the actual process,

$$\dot{m} = \frac{\dot{W}_{\text{out}}}{h_1 - h_2 + h_3 - h_4} = \frac{5000 \text{ kJ/s}}{(3399.5 - 3137.7 + 3468.3 - 2554.5) \text{ kJ/kg}} = 4.253 \text{ kg/s}$$

The reversible (or maximum) power output is determined from the rate form of the exergy balance applied on the turbine and setting the exergy destruction term equal to zero,

$$\underbrace{\dot{X}_{\text{in}} - \dot{X}_{\text{out}}}_{\text{Rate of net exergy transfer by heat, work, and mass}} - \underbrace{\dot{X}_{\text{destroyed}}}_{\text{Rate of exergy destruction}} \stackrel{\text{70 (reversible)}}{=} \underbrace{\Delta \dot{X}_{\text{system}}}_{\text{Rate of change of exergy}} \stackrel{\text{70 (steady)}}{=} 0$$

$$\dot{X}_{\text{in}} = \dot{X}_{\text{out}}$$

$$\dot{m}\psi_1 + \dot{m}\psi_3 = \dot{m}\psi_2 + \dot{m}\psi_4 + \dot{W}_{\text{rev,out}}$$

$$\begin{aligned}
 \dot{W}_{\text{rev,out}} &= \dot{m}(\psi_1 - \psi_2) + \dot{m}(\psi_3 - \psi_4) \\
 &= \dot{m}[(h_1 - h_2) + T_0(s_2 - s_1) - \Delta ke^{\text{70}} - \Delta pe^{\text{70}}] \\
 &\quad + \dot{m}[(h_3 - h_4) + T_0(s_4 - s_3) - \Delta ke^{\text{70}} - \Delta pe^{\text{70}}]
 \end{aligned}$$

Then the reversible power becomes

$$\begin{aligned}
 \dot{W}_{\text{rev,out}} &= \dot{m}[h_1 - h_2 + h_3 - h_4 + T_0(s_2 - s_1 + s_4 - s_3)] \\
 &= (4.253 \text{ kg/s})[(3399.5 - 3137.7 + 3468.3 - 2554.5) \text{ kJ/kg} \\
 &\quad + (298 \text{ K})(6.9583 - 6.7266 + 7.5628 - 7.4337) \text{ kJ/kg} \cdot \text{K}] \\
 &= \mathbf{5457 \text{ kW}}
 \end{aligned}$$

Then the rate of exergy destruction is determined from its definition,

$$\dot{X}_{\text{destroyed}} = \dot{W}_{\text{rev,out}} - \dot{W}_{\text{out}} = 5457 - 5000 = \mathbf{457 \text{ kW}}$$

**8-120** One ton of liquid water at 80°C is brought into a room. The final equilibrium temperature in the room and the entropy generated are to be determined.

**Assumptions 1** The room is well insulated and well sealed. **2** The thermal properties of water and air are constant at room temperature. **3** The system is stationary and thus the kinetic and potential energy changes are zero. **4** There are no work interactions involved.

**Properties** The gas constant of air is  $R = 0.287 \text{ kPa}\cdot\text{m}^3/\text{kg}\cdot\text{K}$  (Table A-1). The constant volume specific heat of water at room temperature is  $c_v = 0.718 \text{ kJ/kg}\cdot^\circ\text{C}$  (Table A-2). The specific heat of water at room temperature is  $c = 4.18 \text{ kJ/kg}\cdot^\circ\text{C}$  (Table A-3).

**Analysis** The volume and the mass of the air in the room are

$$V = 4 \times 5 \times 6 = 120 \text{ m}^3$$

$$m_{\text{air}} = \frac{P_1 V_1}{R T_1} = \frac{(100 \text{ kPa})(120 \text{ m}^3)}{(0.2870 \text{ kPa}\cdot\text{m}^3/\text{kg}\cdot\text{K})(295 \text{ K})} = 141.74 \text{ kg}$$

Taking the contents of the room, including the water, as our system, the energy balance can be written as

$$\underbrace{E_{\text{in}} - E_{\text{out}}}_{\text{Net energy transfer by heat, work, and mass}} = \underbrace{\Delta E_{\text{system}}}_{\text{Change in internal, kinetic, potential, etc. energies}}$$

$$0 = \Delta U = (\Delta U)_{\text{water}} + (\Delta U)_{\text{air}}$$

or  $[mc(T_2 - T_1)]_{\text{water}} + [mc_v(T_2 - T_1)]_{\text{air}} = 0$

Substituting,  $(1000 \text{ kg})(4.18 \text{ kJ/kg}\cdot^\circ\text{C})(T_f - 80)^\circ\text{C} + (141.74 \text{ kg})(0.718 \text{ kJ/kg}\cdot^\circ\text{C})(T_f - 22)^\circ\text{C} = 0$

It gives the final equilibrium temperature in the room to be

$$T_f = \mathbf{78.6^\circ\text{C}}$$

(b) We again take the room and the water in it as the system, which is a closed system. Considering that the system is well-insulated and no mass is entering and leaving, the entropy balance for this system can be expressed as

$$\underbrace{S_{\text{in}} - S_{\text{out}}}_{\text{Net entropy transfer by heat and mass}} + \underbrace{S_{\text{gen}}}_{\text{Entropy generation}} = \underbrace{\Delta S_{\text{system}}}_{\text{Change in entropy}}$$

$$0 + S_{\text{gen}} = \Delta S_{\text{air}} + \Delta S_{\text{water}}$$

where

$$\Delta S_{\text{air}} = mc_v \ln \frac{T_2}{T_1} + mR \ln \frac{V_2}{V_1} = (141.74 \text{ kg})(0.718 \text{ kJ/kg}\cdot\text{K}) \ln \frac{351.6 \text{ K}}{295 \text{ K}} = 17.87 \text{ kJ/K}$$

$$\Delta S_{\text{water}} = mc \ln \frac{T_2}{T_1} = (1000 \text{ kg})(4.18 \text{ kJ/kg}\cdot\text{K}) \ln \frac{351.6 \text{ K}}{353 \text{ K}} = -16.36 \text{ kJ/K}$$

Substituting, the entropy generation is determined to be

$$S_{\text{gen}} = 17.87 - 16.36 = 1.51 \text{ kJ/K}$$

The exergy destroyed during a process can be determined from an exergy balance or directly from its definition  $X_{\text{destroyed}} = T_0 S_{\text{gen}}$ ,

$$X_{\text{destroyed}} = T_0 S_{\text{gen}} = (283 \text{ K})(1.51 \text{ kJ/K}) = \mathbf{427 \text{ kJ}}$$

(c) The work potential (the maximum amount of work that can be produced) during a process is simply the reversible work output. Noting that the actual work for this process is zero, it becomes

$$X_{\text{destroyed}} = W_{\text{rev,out}} - W_{\text{act,out}} \rightarrow W_{\text{rev,out}} = X_{\text{destroyed}} = \mathbf{427 \text{ kJ}}$$

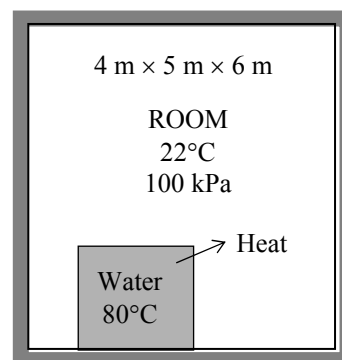



**8-121** An insulated cylinder is divided into two parts. One side of the cylinder contains  $N_2$  gas and the other side contains He gas at different states. The final equilibrium temperature in the cylinder and the wasted work potential are to be determined for the cases of piston being fixed and moving freely.

**Assumptions** **1** Both  $N_2$  and He are ideal gases with constant specific heats. **2** The energy stored in the container itself is negligible. **3** The cylinder is well-insulated and thus heat transfer is negligible.

**Properties** The gas constants and the constant volume specific heats are  $R = 0.2968 \text{ kPa}\cdot\text{m}^3/\text{kg}\cdot\text{K}$  is  $c_v = 0.743 \text{ kJ/kg}\cdot^\circ\text{C}$  for  $N_2$ , and  $R = 2.0769 \text{ kPa}\cdot\text{m}^3/\text{kg}\cdot\text{K}$  is  $c_v = 3.1156 \text{ kJ/kg}\cdot^\circ\text{C}$  for He (Tables A-1 and A-2)

**Analysis** The mass of each gas in the cylinder is

$$m_{N_2} = \left( \frac{P_1 V_1}{RT_1} \right)_{N_2} = \frac{(500 \text{ kPa})(1 \text{ m}^3)}{(0.2968 \text{ kPa}\cdot\text{m}^3/\text{kg}\cdot\text{K})(353 \text{ K})} = 4.77 \text{ kg}$$

$$m_{He} = \left( \frac{P_1 V_1}{RT_1} \right)_{He} = \frac{(500 \text{ kPa})(1 \text{ m}^3)}{(2.0769 \text{ kPa}\cdot\text{m}^3/\text{kg}\cdot\text{K})(298 \text{ K})} = 0.808 \text{ kg}$$

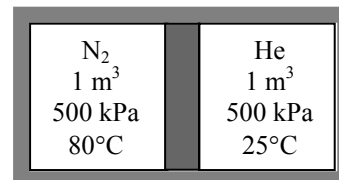

Taking the entire contents of the cylinder as our system, the 1st law relation can be written as

$$\underbrace{E_{in} - E_{out}}_{\substack{\text{Net energy transfer} \\ \text{by heat, work, and mass}}} = \underbrace{\Delta E_{system}}_{\substack{\text{Change in internal, kinetic,} \\ \text{potential, etc. energies}}}$$

$$0 = \Delta U = (\Delta U)_{N_2} + (\Delta U)_{He}$$

$$0 = [mc_v(T_2 - T_1)]_{N_2} + [mc_v(T_2 - T_1)]_{He}$$

Substituting,

$$(4.77 \text{ kg})(0.743 \text{ kJ/kg}\cdot^\circ\text{C})(T_f - 80)^\circ\text{C} + (0.808 \text{ kg})(3.1156 \text{ kJ/kg}\cdot^\circ\text{C})(T_f - 25)^\circ\text{C} = 0$$

It gives

$$T_f = 57.2^\circ\text{C}$$

where  $T_f$  is the final equilibrium temperature in the cylinder.

The answer would be the **same** if the piston were not free to move since it would effect only pressure, and not the specific heats.

(b) We take the entire cylinder as our system, which is a closed system. Noting that the cylinder is well-insulated and thus there is no heat transfer, the entropy balance for this closed system can be expressed as

$$\underbrace{S_{in} - S_{out}}_{\substack{\text{Net entropy transfer} \\ \text{by heat and mass}}} + \underbrace{S_{gen}}_{\substack{\text{Entropy} \\ \text{generation}}} = \underbrace{\Delta S_{system}}_{\substack{\text{Change} \\ \text{in entropy}}}$$

$$0 + S_{gen} = \Delta S_{N_2} + \Delta S_{He}$$

But first we determine the final pressure in the cylinder:

$$N_{total} = N_{N_2} + N_{He} = \left( \frac{m}{M} \right)_{N_2} + \left( \frac{m}{M} \right)_{He} = \frac{4.77 \text{ kg}}{28 \text{ kg/kmol}} + \frac{0.808 \text{ kg}}{4 \text{ kg/kmol}} = 0.372 \text{ kmol}$$

$$P_2 = \frac{N_{total} R_u T}{V_{total}} = \frac{(0.372 \text{ kmol})(8.314 \text{ kPa}\cdot\text{m}^3/\text{kmol}\cdot\text{K})(330.2 \text{ K})}{2 \text{ m}^3} = 510.6 \text{ kPa}$$

Then,

$$\begin{aligned}\Delta S_{N_2} &= m \left( c_p \ln \frac{T_2}{T_1} - R \ln \frac{P_2}{P_1} \right)_{N_2} \\ &= (4.77 \text{ kg}) \left[ (1.039 \text{ kJ/kg} \cdot \text{K}) \ln \frac{330.2 \text{ K}}{353 \text{ K}} - (0.2968 \text{ kJ/kg} \cdot \text{K}) \ln \frac{510.6 \text{ kPa}}{500 \text{ kPa}} \right] = -0.361 \text{ kJ/K}\end{aligned}$$

$$\begin{aligned}\Delta S_{He} &= m \left( c_p \ln \frac{T_2}{T_1} - R \ln \frac{P_2}{P_1} \right)_{He} \\ &= (0.808 \text{ kg}) \left[ (5.1926 \text{ kJ/kg} \cdot \text{K}) \ln \frac{330.2 \text{ K}}{298 \text{ K}} - (2.0769 \text{ kJ/kg} \cdot \text{K}) \ln \frac{510.6 \text{ kPa}}{500 \text{ kPa}} \right] = 0.395 \text{ kJ/K}\end{aligned}$$

$$S_{gen} = \Delta S_{N_2} + \Delta S_{He} = -0.361 + 0.395 = 0.034 \text{ kJ/K}$$

The wasted work potential is equivalent to the exergy destroyed during a process, and it can be determined from an exergy balance or directly from its definition  $X_{destroyed} = T_0 S_{gen}$ ,

$$X_{destroyed} = T_0 S_{gen} = (298 \text{ K})(0.034 \text{ kJ/K}) = \mathbf{10.1 \text{ kJ}}$$

If the piston were not free to move, we would still have  $T_2 = 330.2 \text{ K}$  but the volume of each gas would remain constant in this case:

$$\Delta S_{N_2} = m \left( c_v \ln \frac{T_2}{T_1} - R \ln \frac{v_2^{\phi^0}}{v_1^{\phi^0}} \right)_{N_2} = (4.77 \text{ kg})(0.743 \text{ kJ/kg} \cdot \text{K}) \ln \frac{330.2 \text{ K}}{353 \text{ K}} = -0.237 \text{ kJ/K}$$

$$\Delta S_{He} = m \left( c_v \ln \frac{T_2}{T_1} - R \ln \frac{v_2^{\phi^0}}{v_1^{\phi^0}} \right)_{He} = (0.808 \text{ kg})(3.1156 \text{ kJ/kg} \cdot \text{K}) \ln \frac{330.2 \text{ K}}{298 \text{ K}} = 0.258 \text{ kJ/K}$$

$$S_{gen} = \Delta S_{N_2} + \Delta S_{He} = -0.237 + 0.258 = 0.021 \text{ kJ/K}$$

and

$$X_{destroyed} = T_0 S_{gen} = (298 \text{ K})(0.021 \text{ kJ/K}) = \mathbf{6.26 \text{ kJ}}$$

**8-122** An insulated cylinder is divided into two parts. One side of the cylinder contains  $N_2$  gas and the other side contains He gas at different states. The final equilibrium temperature in the cylinder and the wasted work potential are to be determined for the cases of piston being fixed and moving freely.  $\checkmark$

**Assumptions 1** Both  $N_2$  and He are ideal gases with constant specific heats. **2** The energy stored in the container itself, except the piston, is negligible. **3** The cylinder is well-insulated and thus heat transfer is negligible. **4** Initially, the piston is at the average temperature of the two gases.

**Properties** The gas constants and the constant volume specific heats are  $R = 0.2968 \text{ kPa}\cdot\text{m}^3/\text{kg}\cdot\text{K}$  is  $c_v = 0.743 \text{ kJ/kg}\cdot^\circ\text{C}$  for  $N_2$ , and  $R = 2.0769 \text{ kPa}\cdot\text{m}^3/\text{kg}\cdot\text{K}$  is  $c_v = 3.1156 \text{ kJ/kg}\cdot^\circ\text{C}$  for He (Tables A-1 and A-2). The specific heat of copper piston is  $c = 0.386 \text{ kJ/kg}\cdot^\circ\text{C}$  (Table A-3).

**Analysis** The mass of each gas in the cylinder is

$$m_{N_2} = \left( \frac{P_1 V_1}{RT_1} \right)_{N_2} = \frac{(500 \text{ kPa})(1 \text{ m}^3)}{(0.2968 \text{ kPa}\cdot\text{m}^3/\text{kg}\cdot\text{K})(353 \text{ K})} = 4.77 \text{ kg}$$

$$m_{He} = \left( \frac{P_1 V_1}{RT_1} \right)_{He} = \frac{(500 \text{ kPa})(1 \text{ m}^3)}{(2.0769 \text{ kPa}\cdot\text{m}^3/\text{kg}\cdot\text{K})(353 \text{ K})} = 0.808 \text{ kg}$$

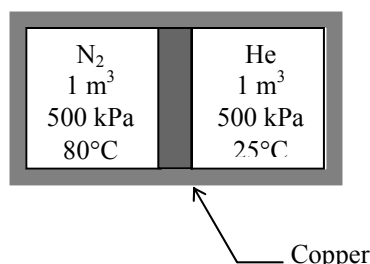

Taking the entire contents of the cylinder as our system, the 1st law relation can be written as

$$\underbrace{E_{in} - E_{out}}_{\substack{\text{Net energy transfer} \\ \text{by heat, work, and mass}}} = \underbrace{\Delta E_{system}}_{\substack{\text{Change in internal, kinetic,} \\ \text{potential, etc. energies}}}$$

$$0 = \Delta U = (\Delta U)_{N_2} + (\Delta U)_{He} + (\Delta U)_{Cu}$$

$$0 = [mc_v(T_2 - T_1)]_{N_2} + [mc_v(T_2 - T_1)]_{He} + [mc(T_2 - T_1)]_{Cu}$$

where

$$T_{1,Cu} = (80 + 25) / 2 = 52.5^\circ\text{C}$$

Substituting,

$$(4.77 \text{ kg})(0.743 \text{ kJ/kg}\cdot^\circ\text{C})(T_f - 80)^\circ\text{C} + (0.808 \text{ kg})(3.1156 \text{ kJ/kg}\cdot^\circ\text{C})(T_f - 25)^\circ\text{C} \\ + (5.0 \text{ kg})(0.386 \text{ kJ/kg}\cdot^\circ\text{C})(T_f - 52.5)^\circ\text{C} = 0$$

It gives

$$T_f = \mathbf{56.0^\circ\text{C}}$$

where  $T_f$  is the final equilibrium temperature in the cylinder.

The answer would be the **same** if the piston were not free to move since it would effect only pressure, and not the specific heats.

(b) We take the entire cylinder as our system, which is a closed system. Noting that the cylinder is well-insulated and thus there is no heat transfer, the entropy balance for this closed system can be expressed as

$$\underbrace{S_{in} - S_{out}}_{\substack{\text{Net entropy transfer} \\ \text{by heat and mass}}} + \underbrace{S_{gen}}_{\substack{\text{Entropy} \\ \text{generation}}} = \underbrace{\Delta S_{system}}_{\substack{\text{Change} \\ \text{in entropy}}}$$

$$0 + S_{gen} = \Delta S_{N_2} + \Delta S_{He} + \Delta S_{piston}$$

But first we determine the final pressure in the cylinder:

$$N_{\text{total}} = N_{\text{N}_2} + N_{\text{He}} = \left(\frac{m}{M}\right)_{\text{N}_2} + \left(\frac{m}{M}\right)_{\text{He}} = \frac{4.77 \text{ kg}}{28 \text{ kg/kmol}} + \frac{0.808 \text{ kg}}{4 \text{ kg/kmol}} = 0.372 \text{ kmol}$$

$$P_2 = \frac{N_{\text{total}} R_u T}{V_{\text{total}}} = \frac{(0.372 \text{ kmol})(8.314 \text{ kPa} \cdot \text{m}^3/\text{kmol} \cdot \text{K})(329 \text{ K})}{2 \text{ m}^3} = 508.8 \text{ kPa}$$

Then,

$$\Delta S_{\text{N}_2} = m \left( c_p \ln \frac{T_2}{T_1} - R \ln \frac{P_2}{P_1} \right)_{\text{N}_2}$$

$$= (4.77 \text{ kg}) \left[ (1.039 \text{ kJ/kg} \cdot \text{K}) \ln \frac{329 \text{ K}}{353 \text{ K}} - (0.2968 \text{ kJ/kg} \cdot \text{K}) \ln \frac{508.8 \text{ kPa}}{500 \text{ kPa}} \right] = -0.374 \text{ kJ/K}$$

$$\Delta S_{\text{He}} = m \left( c_p \ln \frac{T_2}{T_1} - R \ln \frac{P_2}{P_1} \right)_{\text{He}}$$

$$= (0.808 \text{ kg}) \left[ (5.1926 \text{ kJ/kg} \cdot \text{K}) \ln \frac{329 \text{ K}}{353 \text{ K}} - (2.0769 \text{ kJ/kg} \cdot \text{K}) \ln \frac{508.8 \text{ kPa}}{500 \text{ kPa}} \right] = 0.386 \text{ kJ/K}$$

$$\Delta S_{\text{piston}} = \left( mc \ln \frac{T_2}{T_1} \right)_{\text{piston}} = (5 \text{ kg})(0.386 \text{ kJ/kg} \cdot \text{K}) \ln \frac{329 \text{ K}}{325.5 \text{ K}} = 0.021 \text{ kJ/K}$$

$$S_{\text{gen}} = \Delta S_{\text{N}_2} + \Delta S_{\text{He}} + \Delta S_{\text{piston}} = -0.374 + 0.386 + 0.021 = 0.0334 \text{ kJ/K}$$

The wasted work potential is equivalent to the exergy destroyed during a process, and it can be determined from an exergy balance or directly from its definition  $X_{\text{destroyed}} = T_0 S_{\text{gen}}$ ,

$$X_{\text{destroyed}} = T_0 S_{\text{gen}} = (298 \text{ K})(0.033 \text{ kJ/K}) = \mathbf{9.83 \text{ kJ}}$$

If the piston were not free to move, we would still have  $T_2 = 330.2 \text{ K}$  but the volume of each gas would remain constant in this case:

$$\Delta S_{\text{N}_2} = m \left( c_v \ln \frac{T_2}{T_1} - R \ln \frac{V_2}{V_1} \right)_{\text{N}_2}^{\phi^0} = (4.77 \text{ kg})(0.743 \text{ kJ/kg} \cdot \text{K}) \ln \frac{329 \text{ K}}{353 \text{ K}} = -0.250 \text{ kJ/K}$$

$$\Delta S_{\text{He}} = m \left( c_v \ln \frac{T_2}{T_1} - R \ln \frac{V_2}{V_1} \right)_{\text{He}}^{\phi^0} = (0.808 \text{ kg})(3.1156 \text{ kJ/kg} \cdot \text{K}) \ln \frac{329 \text{ K}}{353 \text{ K}} = 0.249 \text{ kJ/K}$$

$$S_{\text{gen}} = \Delta S_{\text{N}_2} + \Delta S_{\text{He}} + \Delta S_{\text{piston}} = -0.250 + 0.249 + 0.021 = \mathbf{0.020 \text{ kJ/K}}$$

and

$$X_{\text{destroyed}} = T_0 S_{\text{gen}} = (298 \text{ K})(0.020 \text{ kJ/K}) = \mathbf{6.0 \text{ kJ}}$$

**8-123E** Argon enters an adiabatic turbine at a specified state with a specified mass flow rate, and leaves at a specified pressure. The isentropic efficiency of turbine is to be determined.

**Assumptions 1** This is a steady-flow process since there is no change with time. **2** Kinetic and potential energy changes are negligible. **3** The device is adiabatic and thus heat transfer is negligible. **4** Argon is an ideal gas with constant specific heats.

**Properties** The specific heat ratio of argon is  $k = 1.667$ . The constant pressure specific heat of argon is  $c_p = 0.1253 \text{ Btu/lbm}\cdot\text{R}$  (Table A-2E).

**Analysis** There is only one inlet and one exit, and thus  $\dot{m}_1 = \dot{m}_2 = \dot{m}$ . We take the isentropic turbine as the system, which is a control volume since mass crosses the boundary. The energy balance for this steady-flow system can be expressed in the rate form as

$$\underbrace{\dot{E}_{\text{in}} - \dot{E}_{\text{out}}}_{\text{Rate of net energy transfer by heat, work, and mass}} = \underbrace{\Delta \dot{E}_{\text{system}}^{\text{no}}}_{\text{Rate of change in internal, kinetic, potential, etc. energies}} = 0$$

$$\dot{E}_{\text{in}} = \dot{E}_{\text{out}}$$

$$\dot{m}h_1 = \dot{W}_{s,\text{out}} + \dot{m}h_{2s} \quad (\text{since } \dot{Q} \cong \Delta ke \cong \Delta pe \cong 0)$$

$$\dot{W}_{s,\text{out}} = \dot{m}(h_1 - h_{2s})$$

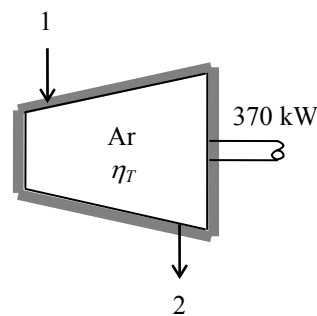

From the isentropic relations,

$$T_{2s} = T_1 \left( \frac{P_{2s}}{P_1} \right)^{(k-1)/k} = (1960 \text{ R}) \left( \frac{30 \text{ psia}}{200 \text{ psia}} \right)^{0.667/1.667} = 917.5 \text{ R}$$

Then the power output of the isentropic turbine becomes

$$\dot{W}_{s,\text{out}} = \dot{m}c_p(T_1 - T_{2s}) = (40 \text{ lbm/min})(0.1253 \text{ Btu/lbm}\cdot\text{R})(1960 - 917.5) \text{ R} \left( \frac{1 \text{ hp}}{42.41 \text{ Btu/min}} \right) = 123.2 \text{ hp}$$

Then the isentropic efficiency of the turbine is determined from

$$\eta_T = \frac{\dot{W}_{a,\text{out}}}{\dot{W}_{s,\text{out}}} = \frac{95 \text{ hp}}{123.2 \text{ hp}} = 0.771 = \mathbf{77.1\%}$$

(b) Using the steady-flow energy balance relation  $\dot{W}_{a,\text{out}} = \dot{m}c_p(T_1 - T_2)$  above, the actual turbine exit temperature is determined to be

$$T_2 = T_1 - \frac{\dot{W}_{a,\text{out}}}{\dot{m}c_p} = 1500 - \frac{95 \text{ hp}}{(40 \text{ lbm/min})(0.1253 \text{ Btu/lbm}\cdot\text{R})} \left( \frac{42.41 \text{ Btu/min}}{1 \text{ hp}} \right) = 696.1^\circ\text{F} = 1156.1 \text{ R}$$

The entropy generation during this process can be determined from an entropy balance on the turbine,

$$\underbrace{\dot{S}_{\text{in}} - \dot{S}_{\text{out}}}_{\text{Rate of net entropy transfer by heat and mass}} + \underbrace{\dot{S}_{\text{gen}}}_{\text{Rate of entropy generation}} = \underbrace{\Delta \dot{S}_{\text{system}}^{\text{no}}}_{\text{Rate of change of entropy}} = 0$$

$$\dot{m}s_1 - \dot{m}s_2 + \dot{S}_{\text{gen}} = 0$$

$$\dot{S}_{\text{gen}} = \dot{m}(s_2 - s_1)$$

where

$$\begin{aligned}
 s_2 - s_1 &= c_p \ln \frac{T_2}{T_1} - R \ln \frac{P_2}{P_1} \\
 &= (0.1253 \text{ Btu/lbm} \cdot \text{R}) \ln \frac{1156.1 \text{ R}}{1960 \text{ R}} - (0.04971 \text{ Btu/lbm} \cdot \text{R}) \ln \frac{30 \text{ psia}}{200 \text{ psia}} \\
 &= 0.02816 \text{ Btu/lbm} \cdot \text{R}
 \end{aligned}$$

The exergy destroyed during a process can be determined from an exergy balance or directly from its definition  $\dot{X}_{\text{destroyed}} = T_0 \dot{S}_{\text{gen}}$ ,

$$\begin{aligned}
 \dot{X}_{\text{destroyed}} &= T_0 \dot{S}_{\text{gen}} = \dot{m} T_0 (s_2 - s_1) \\
 &= (40 \text{ lbm/min})(537 \text{ R})(0.02816 \text{ Btu/lbm} \cdot \text{R}) \left( \frac{1 \text{ hp}}{42.41 \text{ Btu/min}} \right) \\
 &= 14.3 \text{ hp}
 \end{aligned}$$

Then the reversible power and second-law efficiency become

$$\dot{W}_{\text{rev,out}} = \dot{W}_{a,\text{out}} + \dot{X}_{\text{destroyed}} = 95 + 14.3 = 109.3 \text{ hp}$$

and

$$\eta_{\text{II}} = \frac{\dot{W}}{\dot{W}_{\text{rev}}} = \frac{95 \text{ hp}}{109.3 \text{ hp}} = \mathbf{86.9\%}$$

**8-124** The feedwater of a steam power plant is preheated using steam extracted from the turbine. The ratio of the mass flow rates of the extracted steam and the feedwater are to be determined.

**Assumptions 1** This is a steady-flow process since there is no change with time. **2** Kinetic and potential energy changes are negligible. **3** Heat loss from the device to the surroundings is negligible and thus heat transfer from the hot fluid is equal to the heat transfer to the cold fluid.

**Properties** The properties of steam and feedwater are (Tables A-4 through A-6)

$$\left. \begin{array}{l} P_1 = 1 \text{ MPa} \\ T_1 = 200^\circ\text{C} \end{array} \right\} \begin{array}{l} h_1 = 2828.3 \text{ kJ/kg} \\ s_1 = 6.6956 \text{ kJ/kg}\cdot\text{K} \end{array}$$

$$\left. \begin{array}{l} P_2 = 1 \text{ MPa} \\ \text{sat. liquid} \end{array} \right\} \begin{array}{l} h_2 = h_{f@1 \text{ MPa}} = 762.51 \text{ kJ/kg} \\ s_2 = s_{f@1 \text{ MPa}} = 2.1381 \text{ kJ/kg}\cdot\text{K} \\ T_2 = 179.88^\circ\text{C} \end{array}$$

$$\left. \begin{array}{l} P_3 = 2.5 \text{ MPa} \\ T_3 = 50^\circ\text{C} \end{array} \right\} \begin{array}{l} h_3 \cong h_{f@50^\circ\text{C}} = 209.34 \text{ kJ/kg} \\ s_3 \cong s_{f@50^\circ\text{C}} = 0.7038 \text{ kJ/kg}\cdot\text{K} \end{array}$$

$$\left. \begin{array}{l} P_4 = 2.5 \text{ MPa} \\ T_4 = T_2 - 10^\circ\text{C} \cong 170^\circ\text{C} \end{array} \right\} \begin{array}{l} h_4 \cong h_{f@170^\circ\text{C}} = 719.08 \text{ kJ/kg} \\ s_4 \cong s_{f@170^\circ\text{C}} = 2.0417 \text{ kJ/kg}\cdot\text{K} \end{array}$$

**Analysis (a)** We take the heat exchanger as the system, which is a control volume. The mass and energy balances for this steady-flow system can be expressed in the rate form as follows:

**Mass balance** (for each fluid stream):

$$\dot{m}_{\text{in}} - \dot{m}_{\text{out}} = \Delta \dot{m}_{\text{system}} \stackrel{\approx 0 \text{ (steady)}}{=} 0 \rightarrow \dot{m}_{\text{in}} = \dot{m}_{\text{out}} \rightarrow \dot{m}_1 = \dot{m}_2 = \dot{m}_s \quad \text{and} \quad \dot{m}_3 = \dot{m}_4 = \dot{m}_{fw}$$

**Energy balance** (for the heat exchanger):

$$\underbrace{\dot{E}_{\text{in}} - \dot{E}_{\text{out}}}_{\text{Rate of net energy transfer by heat, work, and mass}} = \underbrace{\Delta \dot{E}_{\text{system}} \stackrel{\approx 0 \text{ (steady)}}{=}}_{\text{Rate of change in internal, kinetic, potential, etc. energies}} = 0 \rightarrow \dot{E}_{\text{in}} = \dot{E}_{\text{out}}$$

$$\dot{m}_1 h_1 + \dot{m}_3 h_3 = \dot{m}_2 h_2 + \dot{m}_4 h_4 \quad (\text{since } \dot{Q} = \dot{W} = \Delta \dot{ke} \cong \Delta \dot{pe} \cong 0)$$

Combining the two,  $\dot{m}_s (h_2 - h_1) = \dot{m}_{fw} (h_3 - h_4)$

Dividing by  $\dot{m}_{fw}$  and substituting,

$$\frac{\dot{m}_s}{\dot{m}_{fw}} = \frac{h_3 - h_4}{h_2 - h_1} = \frac{(209.34 - 719.08) \text{ kJ/kg}}{(762.51 - 2828.3) \text{ kJ/kg}} = \mathbf{0.247}$$

**(b)** The entropy generation during this process per unit mass of feedwater can be determined from an entropy balance on the feedwater heater expressed in the rate form as

$$\underbrace{\dot{S}_{\text{in}} - \dot{S}_{\text{out}}}_{\text{Rate of net entropy transfer by heat and mass}} + \underbrace{\dot{S}_{\text{gen}}}_{\text{Rate of entropy generation}} = \underbrace{\Delta \dot{S}_{\text{system}} \stackrel{\approx 0}{=}}_{\text{Rate of change of entropy}} = 0$$

$$\dot{m}_1 s_1 - \dot{m}_2 s_2 + \dot{m}_3 s_3 - \dot{m}_4 s_4 + \dot{S}_{\text{gen}} = 0$$

$$\dot{m}_s (s_1 - s_2) + \dot{m}_{fw} (s_3 - s_4) + \dot{S}_{\text{gen}} = 0$$

$$\frac{\dot{S}_{\text{gen}}}{\dot{m}_{fw}} = \frac{\dot{m}_s}{\dot{m}_{fw}} (s_2 - s_1) + (s_4 - s_3) = (0.247)(2.1381 - 6.6956) + (2.0417 - 0.7038) = 0.213 \text{ kJ/K}\cdot\text{kg fw}$$

Noting that this process involves no actual work, the reversible work and exergy destruction become equivalent since  $X_{\text{destroyed}} = W_{\text{rev,out}} - W_{\text{act,out}} \rightarrow W_{\text{rev,out}} = X_{\text{destroyed}}$ . The exergy destroyed during a process can be determined from an exergy balance or directly from its definition  $X_{\text{destroyed}} = T_0 S_{\text{gen}}$ ,

$$X_{\text{destroyed}} = T_0 S_{\text{gen}} = (298 \text{ K})(0.213 \text{ kJ/K}\cdot\text{kgfw}) = \mathbf{63.5 \text{ kJ/kgfeedwater}}$$

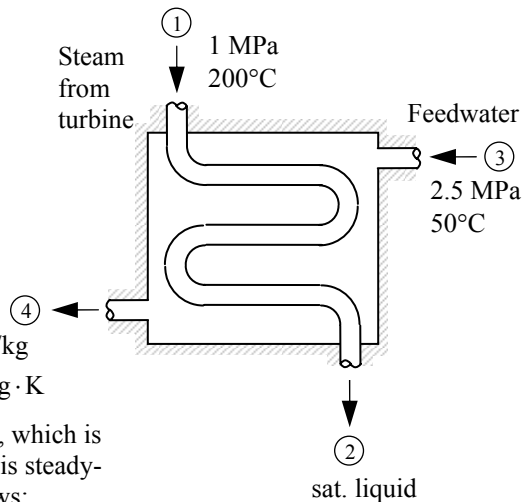

**8-125 EES** Problem 8-124 is reconsidered. The effect of the state of the steam at the inlet of the feedwater heater on the ratio of mass flow rates and the reversible power is to be investigated.

*Analysis* Using EES, the problem is solved as follows:

"Input Data"

"Steam (let st=steam data):"

Fluid\$='Steam\_IAPWS'

T\_st[1]=200 [C]

{P\_st[1]=1000 [kPa]}

P\_st[2] = P\_st[1]

x\_st[2]=0 "saturated liquid, quality = 0%"

T\_st[2]=temperature(steam, P=P\_st[2], x=x\_st[2])

"Feedwater (let fw=feedwater data):"

T\_fw[1]=50 [C]

P\_fw[1]=2500 [kPa]

P\_fw[2]=P\_fw[1] "assume no pressure drop for the feedwater"

T\_fw[2]=T\_st[2]-10

"Surroundings:"

T\_o = 25 [C]

P\_o = 100 [kPa] "Assumed value for the surroundings pressure"

"Conservation of mass:"

"There is one entrance, one exit for both the steam and feedwater."

"Steam: m\_dot\_st[1] = m\_dot\_st[2]"

"Feedwater: m\_dot\_fw[1] = m\_dot\_fw[2]"

"Let m\_ratio = m\_dot\_st/m\_dot\_fw"

"Conservation of Energy:"

"We write the conservation of energy for steady-flow control volume having two entrances and two exits with the above assumptions. Since neither of the flow rates is know or can be found, write the conservation of energy per unit mass of the feedwater."

E\_in - E\_out = DELTAE\_cv

DELTA E\_cv=0 "Steady-flow requirement"

E\_in = m\_ratio\*h\_st[1] + h\_fw[1]

h\_st[1]=enthalpy(Fluid\$, T=T\_st[1], P=P\_st[1])

h\_fw[1]=enthalpy(Fluid\$, T=T\_fw[1], P=P\_fw[1])

E\_out = m\_ratio\*h\_st[2] + h\_fw[2]

h\_fw[2]=enthalpy(Fluid\$, T=T\_fw[2], P=P\_fw[2])

h\_st[2]=enthalpy(Fluid\$, x=x\_st[2], P=P\_st[2])

"The reversible work is given by Eq. 7-47, where the heat transfer is zero (the feedwater heater is adiabatic) and the Exergy destroyed is set equal to zero"

W\_rev = m\_ratio\*(Psi\_st[1]-Psi\_st[2]) +(Psi\_fw[1]-Psi\_fw[2])

Psi\_st[1]=h\_st[1]-h\_st\_o -(T\_o + 273)\*(s\_st[1]-s\_st\_o)

s\_st[1]=entropy(Fluid\$, T=T\_st[1], P=P\_st[1])

h\_st\_o=enthalpy(Fluid\$, T=T\_o, P=P\_o)

s\_st\_o=entropy(Fluid\$, T=T\_o, P=P\_o)

Psi\_st[2]=h\_st[2]-h\_st\_o -(T\_o + 273)\*(s\_st[2]-s\_st\_o)

s\_st[2]=entropy(Fluid\$, x=x\_st[2], P=P\_st[2])

Psi\_fw[1]=h\_fw[1]-h\_fw\_o -(T\_o + 273)\*(s\_fw[1]-s\_fw\_o)

h\_fw\_o=enthalpy(Fluid\$, T=T\_o, P=P\_o)

s\_fw[1]=entropy(Fluid\$, T=T\_fw[1], P=P\_fw[1])

s\_fw\_o=entropy(Fluid\$, T=T\_o, P=P\_o)



$$\text{Psi\_fw}[2]=h\_fw[2]-h\_fw\_o-(T\_o+273)*(s\_fw[2]-s\_fw\_o)$$

$$s\_fw[2]=\text{entropy}(\text{Fluid}\$,T=T\_fw[2],P=P\_fw[2])$$

$m_{\text{ratio}}$ [kg/kg]	$W_{\text{rev}}$ [kJ/kg]	$P_{\text{st},1}$ [kPa]
0.06745	12.9	100
0.1067	23.38	200
0.1341	31.24	300
0.1559	37.7	400
0.1746	43.26	500
0.1912	48.19	600
0.2064	52.64	700
0.2204	56.72	800
0.2335	60.5	900
0.246	64.03	1000

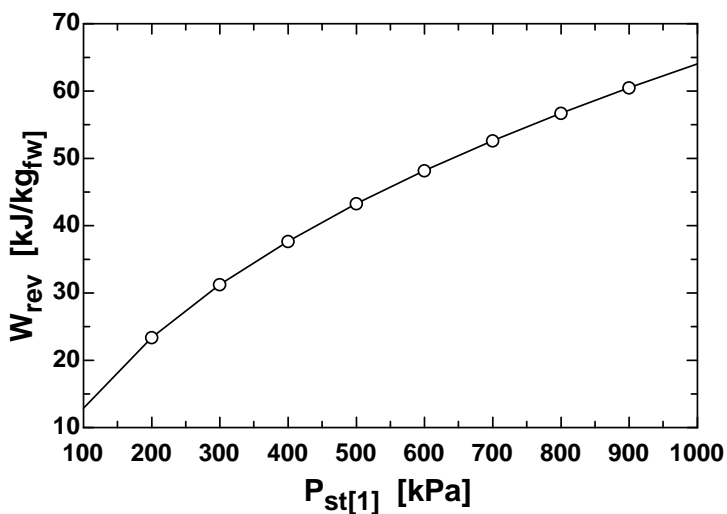
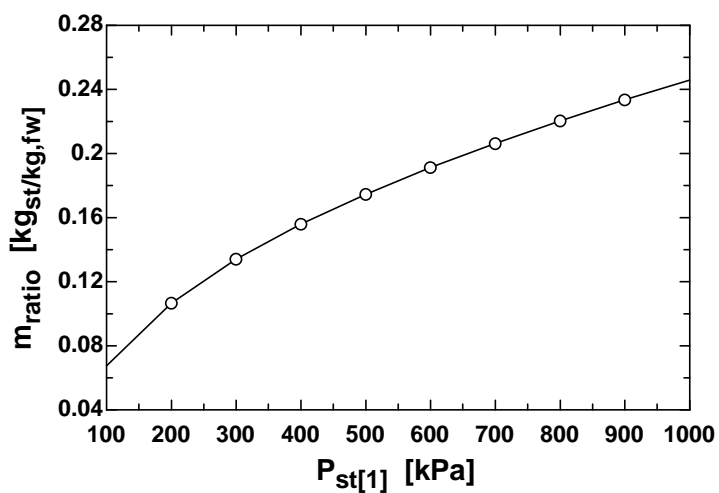

**8-126** A 1-ton (1000 kg) of water is to be cooled in a tank by pouring ice into it. The final equilibrium temperature in the tank and the exergy destruction are to be determined.

**Assumptions** **1** Thermal properties of the ice and water are constant. **2** Heat transfer to the water tank is negligible. **3** There is no stirring by hand or a mechanical device (it will add energy).

**Properties** The specific heat of water at room temperature is  $c = 4.18 \text{ kJ/kg}\cdot\text{C}$ , and the specific heat of ice at about  $0^\circ\text{C}$  is  $c = 2.11 \text{ kJ/kg}\cdot\text{C}$  (Table A-3). The melting temperature and the heat of fusion of ice at 1 atm are  $0^\circ\text{C}$  and  $333.7 \text{ kJ/kg}$ .

**Analysis** (a) We take the ice and the water as the system, and disregard any heat transfer between the system and the surroundings. Then the energy balance for this process can be written as

$$\underbrace{E_{\text{in}} - E_{\text{out}}}_{\substack{\text{Net energy transfer} \\ \text{by heat, work, and mass}}} = \underbrace{\Delta E_{\text{system}}}_{\substack{\text{Change in internal, kinetic,} \\ \text{potential, etc. energies}}}$$

$$0 = \Delta U$$

$$0 = \Delta U_{\text{ice}} + \Delta U_{\text{water}}$$

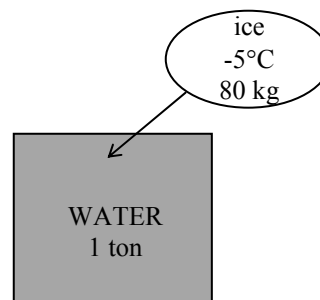

$$[mc(0^\circ\text{C} - T_1)_{\text{solid}} + mh_{if} + mc(T_2 - 0^\circ\text{C})_{\text{liquid}}]_{\text{ice}} + [mc(T_2 - T_1)]_{\text{water}} = 0$$

Substituting,

$$(80 \text{ kg}) \{ (2.11 \text{ kJ/kg}\cdot\text{C}) [0 - (-5)]^\circ\text{C} + 333.7 \text{ kJ/kg} + (4.18 \text{ kJ/kg}\cdot\text{C})(T_2 - 0^\circ\text{C}) \} \\ + (1000 \text{ kg})(4.18 \text{ kJ/kg}\cdot\text{C})(T_2 - 20^\circ\text{C}) = 0$$

It gives  $T_2 = 12.42^\circ\text{C}$

which is the final equilibrium temperature in the tank.

(b) We take the ice and the water as our system, which is a closed system. Considering that the tank is well-insulated and thus there is no heat transfer, the entropy balance for this closed system can be expressed as

$$\underbrace{S_{\text{in}} - S_{\text{out}}}_{\substack{\text{Net entropy transfer} \\ \text{by heat and mass}}} + \underbrace{S_{\text{gen}}}_{\substack{\text{Entropy} \\ \text{generation}}} = \underbrace{\Delta S_{\text{system}}}_{\substack{\text{Change} \\ \text{in entropy}}} \\ 0 + S_{\text{gen}} = \Delta S_{\text{ice}} + \Delta S_{\text{water}}$$

where

$$\Delta S_{\text{water}} = \left( mc \ln \frac{T_2}{T_1} \right)_{\text{water}} = (1000 \text{ kg})(4.18 \text{ kJ/kg}\cdot\text{K}) \ln \frac{285.42 \text{ K}}{293 \text{ K}} = -109.590 \text{ kJ/K} \\ \Delta S_{\text{ice}} = \left( \Delta S_{\text{solid}} + \Delta S_{\text{melting}} + \Delta S_{\text{liquid}} \right)_{\text{ice}} \\ = \left( \left( mc \ln \frac{T_{\text{melting}}}{T_1} \right)_{\text{solid}} + \frac{mh_{if}}{T_{\text{melting}}} + \left( mc \ln \frac{T_2}{T_1} \right)_{\text{liquid}} \right)_{\text{ice}} \\ = (80 \text{ kg}) \left( (2.11 \text{ kJ/kg}\cdot\text{K}) \ln \frac{273 \text{ K}}{268 \text{ K}} + \frac{333.7 \text{ kJ/kg}}{273 \text{ K}} + (4.18 \text{ kJ/kg}\cdot\text{K}) \ln \frac{285.42 \text{ K}}{273 \text{ K}} \right) \\ = 115.783 \text{ kJ/K}$$

Then,  $S_{\text{gen}} = \Delta S_{\text{water}} + \Delta S_{\text{ice}} = -109.590 + 115.783 = 6.193 \text{ kJ/K}$

The exergy destroyed during a process can be determined from an exergy balance or directly from its definition  $X_{\text{destroyed}} = T_0 S_{\text{gen}}$ ,

$$X_{\text{destroyed}} = T_0 S_{\text{gen}} = (293 \text{ K})(6.193 \text{ kJ/K}) = \mathbf{1815 \text{ kJ}}$$

**8-127** An evacuated bottle is surrounded by atmospheric air. A valve is opened, and air is allowed to fill the bottle. The amount of heat transfer through the wall of the bottle when thermal and mechanical equilibrium is established and the amount of exergy destroyed are to be determined.

**Assumptions 1** This is an unsteady process since the conditions within the device are changing during the process, but it can be analyzed as a uniform-flow process since the state of fluid at the inlet remains constant. **2** Air is an ideal gas. **3** Kinetic and potential energies are negligible. **4** There are no work interactions involved. **5** The direction of heat transfer is to the air in the bottle (will be verified).

**Properties** The gas constant of air is  $0.287 \text{ kPa}\cdot\text{m}^3/\text{kg}\cdot\text{K}$  (Table A-1).

**Analysis** We take the bottle as the system, which is a control volume since mass crosses the boundary. Noting that the microscopic energies of flowing and nonflowing fluids are represented by enthalpy  $h$  and internal energy  $u$ , respectively, the mass and energy balances can be expressed as

$$\text{Mass balance: } m_{\text{in}} - m_{\text{out}} = \Delta m_{\text{system}} \rightarrow m_i = m_2 \quad (\text{since } m_{\text{out}} = m_{\text{initial}} = 0)$$

**Energy balance:**

$$\underbrace{E_{\text{in}} - E_{\text{out}}}_{\substack{\text{Net energy transfer} \\ \text{by heat, work, and mass}}} = \underbrace{\Delta E_{\text{system}}}_{\substack{\text{Change in internal, kinetic,} \\ \text{potential, etc. energies}}}$$

$$Q_{\text{in}} + m_i h_i = m_2 u_2 \quad (\text{since } W \cong E_{\text{out}} = E_{\text{initial}} = \text{ke} \cong \text{pe} \cong 0)$$

**Combining the two balances:**

$$Q_{\text{in}} = m_2 (u_2 - h_i)$$

where

$$m_2 = \frac{P_2 V}{RT_2} = \frac{(100 \text{ kPa})(0.012 \text{ m}^3)}{(0.287 \text{ kPa}\cdot\text{m}^3/\text{kg}\cdot\text{K})(290 \text{ K})} = 0.0144 \text{ kg}$$

$$T_i = T_2 = 290 \text{ K} \xrightarrow{\text{Table A-17}} \begin{aligned} h_i &= 290.16 \text{ kJ/kg} \\ u_2 &= 206.91 \text{ kJ/kg} \end{aligned}$$

Substituting,

$$Q_{\text{in}} = (0.0144 \text{ kg})(206.91 - 290.16) \text{ kJ/kg} = -1.2 \text{ kJ} \rightarrow Q_{\text{out}} = \mathbf{1.2 \text{ kJ}}$$

Note that the negative sign for heat transfer indicates that the assumed direction is wrong. Therefore, we reversed the direction.

The entropy generated during this process is determined by applying the entropy balance on an *extended system* that includes the bottle and its immediate surroundings so that the boundary temperature of the extended system is the temperature of the surroundings at all times. The entropy balance for it can be expressed as

$$\underbrace{S_{\text{in}} - S_{\text{out}}}_{\substack{\text{Net entropy transfer} \\ \text{by heat and mass}}} + \underbrace{S_{\text{gen}}}_{\substack{\text{Entropy} \\ \text{generation}}} = \underbrace{\Delta S_{\text{system}}}_{\substack{\text{Change} \\ \text{in entropy}}}$$

$$m_i s_i - \frac{Q_{\text{out}}}{T_{\text{b,in}}} + S_{\text{gen}} = \Delta S_{\text{tank}} = m_2 s_2 - m_1 s_1 \stackrel{\phi=0}{=} m_2 s_2$$

Therefore, the total entropy generated during this process is

$$S_{\text{gen}} = -m_i s_i + m_2 s_2 + \frac{Q_{\text{out}}}{T_{\text{b,out}}} = m_2 (s_2 - s_i) \stackrel{\phi=0}{=} + \frac{Q_{\text{out}}}{T_{\text{b,out}}} = \frac{Q_{\text{out}}}{T_{\text{surr}}} = \frac{1.2 \text{ kJ}}{290 \text{ K}} = 0.00415 \text{ kJ/K}$$

The exergy destroyed during a process can be determined from an exergy balance or directly from its definition  $X_{\text{destroyed}} = T_0 S_{\text{gen}}$ ,

$$X_{\text{destroyed}} = T_0 S_{\text{gen}} = (290 \text{ K})(0.00415 \text{ kJ/K}) = \mathbf{1.2 \text{ kJ}}$$

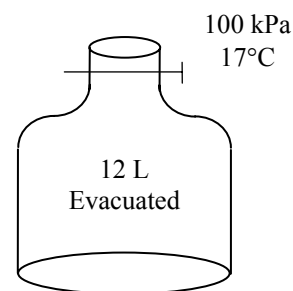

**8-128** A heat engine operates between two tanks filled with air at different temperatures. The maximum work that can be produced and the final temperatures of the tanks are to be determined.

**Assumptions** Air is an ideal gas with constant specific heats at room temperature.

**Properties** The gas constant of air is  $0.287 \text{ kPa}\cdot\text{m}^3/\text{kg}\cdot\text{K}$  (Table A-1). The constant volume specific heat of air at room temperature is  $c_v = 0.718 \text{ kJ/kg}\cdot\text{K}$  (Table A-2).

**Analysis** For maximum power production, the entropy generation must be zero. We take the two tanks (the heat source and heat sink) and the heat engine as the system. Noting that the system involves no heat and mass transfer and that the entropy change for cyclic devices is zero, the entropy balance can be expressed as

$$\underbrace{S_{\text{in}} - S_{\text{out}}}_{\substack{\text{Net entropy transfer} \\ \text{by heat and mass}}} + \underbrace{S_{\text{gen}}}_{\substack{\text{Entropy} \\ \text{generation}}} \stackrel{\approx 0}{=} \underbrace{\Delta S_{\text{system}}}_{\substack{\text{Change} \\ \text{in entropy}}}$$

$$0 + S_{\text{gen}} \stackrel{\approx 0}{=} \Delta S_{\text{tank,source}} + \Delta S_{\text{tank,sink}} + \Delta S_{\text{heat engine}} \stackrel{\approx 0}{=}$$

$$\Delta S_{\text{tank,source}} + \Delta S_{\text{tank,sink}} = 0$$

$$\left( mc_v \ln \frac{T_2}{T_1} + mR \ln \frac{v_2}{v_1} \right)_{\text{source}} + \left( mc_v \ln \frac{T_2}{T_1} + mR \ln \frac{v_2}{v_1} \right)_{\text{sink}} \stackrel{\approx 0}{=} 0$$

$$\ln \frac{T_2}{T_{1A}} \frac{T_2}{T_{1B}} = 0 \longrightarrow T_2^2 = T_{1A} T_{1B}$$

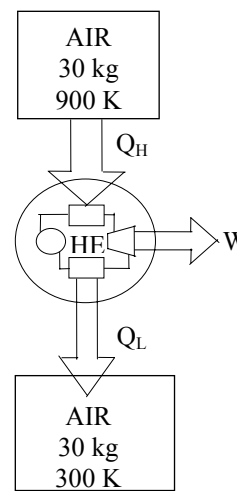

where  $T_{1A}$  and  $T_{1B}$  are the initial temperatures of the source and the sink, respectively, and  $T_2$  is the common final temperature. Therefore, the final temperature of the tanks for maximum power production is

$$T_2 = \sqrt{T_{1A} T_{1B}} = \sqrt{(900 \text{ K})(300 \text{ K})} = \mathbf{519.6 \text{ K}}$$

The energy balance  $E_{\text{in}} - E_{\text{out}} = \Delta E_{\text{system}}$  for the source and sink can be expressed as follows:

*Source:*

$$-Q_{\text{source,out}} = \Delta U = mc_v(T_2 - T_{1A}) \rightarrow Q_{\text{source,out}} = mc_v(T_{1A} - T_2)$$

$$Q_{\text{source,out}} = mc_v(T_{1A} - T_2) = (30 \text{ kg})(0.718 \text{ kJ/kg}\cdot\text{K})(900 - 519.6)\text{K} = 8193 \text{ kJ}$$

*Sink:*

$$Q_{\text{sink,in}} = mc_v(T_2 - T_{1B}) = (30 \text{ kg})(0.718 \text{ kJ/kg}\cdot\text{K})(519.6 - 300)\text{K} = 4731 \text{ kJ}$$

Then the work produced in this case becomes

$$W_{\text{max,out}} = Q_H - Q_L = Q_{\text{source,out}} - Q_{\text{sink,in}} = 8193 - 4731 = \mathbf{3463 \text{ kJ}}$$

Therefore, a maximum of 3463 kJ of work can be produced during this process.

**8-129** A heat engine operates between two constant-pressure cylinders filled with air at different temperatures. The maximum work that can be produced and the final temperatures of the cylinders are to be determined.

**Assumptions** Air is an ideal gas with constant specific heats at room temperature.

**Properties** The gas constant of air is  $0.287 \text{ kPa}\cdot\text{m}^3/\text{kg}\cdot\text{K}$  (Table A-1). The constant pressure specific heat of air at room temperature is  $c_p = 1.005 \text{ kJ/kg}\cdot\text{K}$  (Table A-2).

**Analysis** For maximum power production, the entropy generation must be zero. We take the two cylinders (the heat source and heat sink) and the heat engine as the system. Noting that the system involves no heat and mass transfer and that the entropy change for cyclic devices is zero, the entropy balance can be expressed as

$$\underbrace{S_{\text{in}} - S_{\text{out}}}_{\text{Net entropy transfer by heat and mass}} + \underbrace{S_{\text{gen}}}_{\text{Entropy generation}} \stackrel{\approx 0}{=} \underbrace{\Delta S_{\text{system}}}_{\text{Change in entropy}}$$

$$0 + S_{\text{gen}} \stackrel{\approx 0}{=} \Delta S_{\text{cylinder,source}} + \Delta S_{\text{cylinder,sink}} + \Delta S_{\text{heat engine}} \stackrel{\approx 0}{=}$$

$$\Delta S_{\text{cylinder,source}} + \Delta S_{\text{cylinder,sink}} = 0$$

$$\left( mc_p \ln \frac{T_2}{T_1} - mR \ln \frac{P_2}{P_1} \right)_{\text{source}} + 0 + \left( mc_p \ln \frac{T_2}{T_1} - mR \ln \frac{P_2}{P_1} \right)_{\text{sink}} = 0$$

$$\ln \frac{T_2}{T_{1A}} \frac{T_2}{T_{1B}} = 0 \longrightarrow T_2^2 = T_{1A} T_{1B}$$

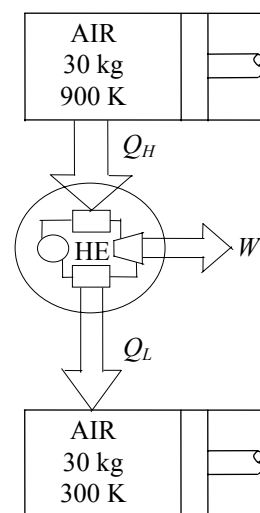

where  $T_{1A}$  and  $T_{1B}$  are the initial temperatures of the source and the sink, respectively, and  $T_2$  is the common final temperature. Therefore, the final temperature of the tanks for maximum power production is

$$T_2 = \sqrt{T_{1A} T_{1B}} = \sqrt{(900 \text{ K})(300 \text{ K})} = \mathbf{519.6 \text{ K}}$$

The energy balance  $E_{\text{in}} - E_{\text{out}} = \Delta E_{\text{system}}$  for the source and sink can be expressed as follows:

*Source:*

$$-Q_{\text{source,out}} + W_{b,\text{in}} = \Delta U \rightarrow Q_{\text{source,out}} = \Delta H = mc_p (T_{1A} - T_2)$$

$$Q_{\text{source,out}} = mc_p (T_{1A} - T_2) = (30 \text{ kg})(1.005 \text{ kJ/kg}\cdot\text{K})(900 - 519.6) \text{ K} = 11,469 \text{ kJ}$$

*Sink:*

$$Q_{\text{sink,in}} - W_{b,\text{out}} = \Delta U \rightarrow Q_{\text{sink,in}} = \Delta H = mc_p (T_2 - T_{1A})$$

$$Q_{\text{sink,in}} = mc_p (T_2 - T_{1B}) = (30 \text{ kg})(1.005 \text{ kJ/kg}\cdot\text{K})(519.6 - 300) \text{ K} = 6621 \text{ kJ}$$

Then the work produced becomes

$$W_{\text{max,out}} = Q_H - Q_L = Q_{\text{source,out}} - Q_{\text{sink,in}} = 11,469 - 6621 = \mathbf{4847 \text{ kJ}}$$

Therefore, a maximum of 4847 kJ of work can be produced during this process

**8-130** A heat engine operates between a nitrogen tank and an argon cylinder at different temperatures. The maximum work that can be produced and the final temperatures are to be determined.

**Assumptions** Nitrogen and argon are ideal gases with constant specific heats at room temperature.

**Properties** The constant volume specific heat of nitrogen at room temperature is  $c_v = 0.743$  kJ/kg·K. The constant pressure specific heat of argon at room temperature is  $c_p = 0.5203$  kJ/kg·K (Table A-2).

**Analysis** For maximum power production, the entropy generation must be zero. We take the tank, the cylinder (the heat source and the heat sink) and the heat engine as the system. Noting that the system involves no heat and mass transfer and that the entropy change for cyclic devices is zero, the entropy balance can be expressed as

$$\underbrace{S_{\text{in}} - S_{\text{out}}}_{\text{Net entropy transfer by heat and mass}} + \underbrace{S_{\text{gen}}}_{\text{Entropy generation}} \stackrel{\approx 0}{=} \underbrace{\Delta S_{\text{system}}}_{\text{Change in entropy}}$$

$$0 + S_{\text{gen}} \stackrel{\approx 0}{=} \Delta S_{\text{tank,source}} + \Delta S_{\text{cylinder,sink}} + \Delta S_{\text{heat engine}} \stackrel{\approx 0}{=}$$

$$(\Delta S)_{\text{source}} + (\Delta S)_{\text{sink}} = 0$$

$$\left( mc_v \ln \frac{T_2}{T_1} - mR \ln \frac{v_2}{v_1} \right)_{\text{source}} + 0 + \left( mc_p \ln \frac{T_2}{T_1} - mR \ln \frac{P_2}{P_1} \right)_{\text{sink}} = 0$$

Substituting,

$$(20 \text{ kg})(0.743 \text{ kJ/kg} \cdot \text{K}) \ln \frac{T_2}{1000 \text{ K}} + (10 \text{ kg})(0.5203 \text{ kJ/kg} \cdot \text{K}) \ln \frac{T_2}{300 \text{ K}} = 0$$

Solving for  $T_2$  yields

$$T_2 = \mathbf{731.8 \text{ K}}$$

where  $T_2$  is the common final temperature of the tanks for maximum power production.

The energy balance  $E_{\text{in}} - E_{\text{out}} = \Delta E_{\text{system}}$  for the source and sink can be expressed as follows:

*Source:*

$$-Q_{\text{source,out}} = \Delta U = mc_v(T_2 - T_{1A}) \rightarrow Q_{\text{source,out}} = mc_v(T_{1A} - T_2)$$

$$Q_{\text{source,out}} = mc_v(T_{1A} - T_2) = (20 \text{ kg})(0.743 \text{ kJ/kg} \cdot \text{K})(1000 - 731.8)\text{K} = 3985 \text{ kJ}$$

*Sink:*

$$Q_{\text{sink,in}} - W_{\text{b,out}} = \Delta U \rightarrow Q_{\text{sink,in}} = \Delta H = mc_p(T_2 - T_{1A})$$

$$Q_{\text{sink,in}} = mc_p(T_2 - T_{1A}) = (10 \text{ kg})(0.5203 \text{ kJ/kg} \cdot \text{K})(731.8 - 300)\text{K} = 2247 \text{ kJ}$$

Then the work produced becomes

$$W_{\text{max,out}} = Q_H - Q_L = Q_{\text{source,out}} - Q_{\text{sink,in}} = 3985 - 2247 = \mathbf{1739 \text{ kJ}}$$

Therefore, a maximum of 1739 kJ of work can be produced during this process

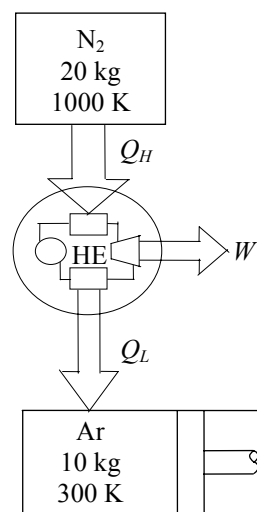

**8-131** A rigid tank containing nitrogen is considered. Heat is now transferred to the nitrogen from a reservoir and nitrogen is allowed to escape until the mass of nitrogen becomes one-half of its initial mass. The change in the nitrogen's work potential is to be determined.

**Assumptions 1** This is an unsteady process since the conditions within the device are changing during the process. **2** Kinetic and potential energies are negligible. **3** There are no work interactions involved. **4** Nitrogen is an ideal gas with constant specific heats.

**Properties** The properties of nitrogen at room temperature are  $c_p = 1.039$  kJ/kg·K,  $c_v = 0.743$  kJ/kg·K, and  $R = 0.2968$  kJ/kg·K (Table A-2a).

**Analysis** The initial and final masses in the tank are

$$m_1 = \frac{P\mathcal{V}}{RT_1} = \frac{(1000 \text{ kPa})(0.100 \text{ m}^3)}{(0.2968 \text{ kPa} \cdot \text{m}^3/\text{kg} \cdot \text{K})(293 \text{ K})} = 1.150 \text{ kg}$$

$$m_2 = m_e = \frac{m_1}{2} = \frac{1.150 \text{ kg}}{2} = 0.575 \text{ kg}$$

The final temperature in the tank is

$$T_2 = \frac{P\mathcal{V}}{m_2 R} = \frac{(1000 \text{ kPa})(0.100 \text{ m}^3)}{(0.575 \text{ kg})(0.2968 \text{ kPa} \cdot \text{m}^3/\text{kg} \cdot \text{K})} = 586 \text{ K}$$

We take the tank as the system, which is a control volume since mass crosses the boundary. Noting that the microscopic energies of flowing and nonflowing fluids are represented by enthalpy  $h$  and internal energy  $u$ , respectively, the mass and energy balances for this uniform-flow system can be expressed as

*Mass balance:*

$$m_{\text{in}} - m_{\text{out}} = \Delta m_{\text{system}} \rightarrow m_e = m_2$$

*Energy balance:*

$$\underbrace{E_{\text{in}} - E_{\text{out}}}_{\substack{\text{Net energy transfer} \\ \text{by heat, work, and mass}}} = \underbrace{\Delta E_{\text{system}}}_{\substack{\text{Change in internal, kinetic,} \\ \text{potential, etc. energies}}}$$

$$Q_{\text{in}} - m_e h_e = m_2 u_2 - m_1 u_1$$

$$Q_{\text{out}} = m_e h_e + m_2 u_2 - m_1 u_1$$

Using the average of the initial and final temperatures for the exiting nitrogen,  $T_e = 0.5(T_1 + T_2) = 0.5((293 + 586) = 439.5$  K this energy balance equation becomes

$$\begin{aligned} Q_{\text{out}} &= m_e h_e + m_2 u_2 - m_1 u_1 \\ &= m_e c_p T_e + m_2 c_v T_2 - m_1 c_v T_1 \\ &= (0.575)(1.039)(439.5) + (0.575)(0.743)(586) - (1.150)(0.743)(293) \\ &= 262.6 \text{ kJ} \end{aligned}$$

The work potential associated with this process is equal to the exergy destroyed during the process. The exergy destruction during a process can be determined from an exergy balance or directly from its definition  $X_{\text{destroyed}} = T_0 S_{\text{gen}}$ . The entropy generation  $S_{\text{gen}}$  in this case is determined from an entropy balance on the system:

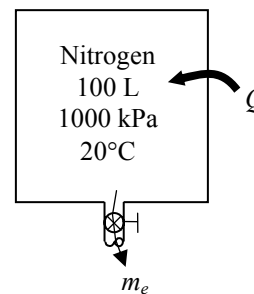

$$\underbrace{S_{\text{in}} - S_{\text{out}}}_{\substack{\text{Net entropy transfer} \\ \text{by heat and mass}}} + \underbrace{S_{\text{gen}}}_{\substack{\text{Entropy} \\ \text{generation}}} = \underbrace{\Delta S_{\text{system}}}_{\substack{\text{Change} \\ \text{in entropy}}}$$

$$\frac{Q_{\text{in}}}{T_R} - m_e s_e + S_{\text{gen}} = \Delta S_{\text{tank}} = m_2 s_2 - m_1 s_1$$

$$S_{\text{gen}} = m_2 s_2 - m_1 s_1 + m_e s_e - \frac{Q_{\text{in}}}{T_R}$$

Noting that pressures are same, rearranging and substituting gives

$$S_{\text{gen}} = m_2 s_2 - m_1 s_1 + m_e s_e - \frac{Q_{\text{in}}}{T_R}$$

$$= m_2 c_p \ln T_2 - m_1 c_p \ln T_1 + m_e c_p \ln T_e - \frac{Q_{\text{in}}}{T_R}$$

$$= (0.575)(1.039) \ln(586) - (1.150)(1.039) \ln(293) + (0.575)(1.039) \ln(439.5) - \frac{262.6}{673}$$

$$= 0.2661 \text{ kJ/K}$$

Then,

$$W_{\text{rev}} = X_{\text{destroyed}} = T_0 S_{\text{gen}} = (293 \text{ K})(0.2661 \text{ kJ/K}) = \mathbf{78.0 \text{ kJ}}$$

#### **Alternative More Accurate Solution**

This problem may also be solved by considering the variation of gas temperature at the outlet of the tank. The mass and energy balances are

$$\dot{m}_e = -\frac{dm}{dt}$$

$$\dot{Q} = \frac{d(mu)}{dt} - h \frac{dm}{dt} = \frac{c_v d(mT)}{dt} - c_p T \frac{dm}{dt}$$

Combining these expressions and replacing  $T$  in the last term gives

$$\dot{Q} = c_v \frac{d(mT)}{dt} - \frac{c_p P \mathcal{V}}{Rm} \frac{dm}{dt}$$

Integrating this over the time required to release one-half the mass produces

$$Q = c_v (m_2 T_2 - m_1 T_1) - \frac{c_p P \mathcal{V}}{R} \ln \frac{m_2}{m_1}$$

The reduced combined first and second law becomes

$$\dot{W}_{\text{rev}} = \dot{Q} \left( 1 - \frac{T_0}{T_R} \right) - \frac{d(U - T_0 S)}{dt} + (h - T_0 s) \frac{dm}{dt}$$

when the mass balance is substituted and the entropy generation is set to zero (for maximum work production). Expanding the system time derivative gives



$$\begin{aligned}
 \dot{W}_{\text{rev}} &= \dot{Q} \left( 1 - \frac{T_0}{T_R} \right) - \frac{d(mu - T_0 ms)}{dt} + (h - T_0 s) \frac{dm}{dt} \\
 &= \dot{Q} \left( 1 - \frac{T_0}{T_R} \right) - \frac{d(mu)}{dt} + T_0 m \frac{ds}{dt} + T_0 s \frac{dm}{dt} + (h - T_0 s) \frac{dm}{dt} \\
 &= \dot{Q} \left( 1 - \frac{T_0}{T_R} \right) - \frac{d(mu)}{dt} + h \frac{dm}{dt} + m \frac{T_0}{T} \frac{dh}{dt}
 \end{aligned}$$

Substituting  $\dot{Q}$  from the first law,

$$\begin{aligned}
 \dot{W}_{\text{rev}} &= \left[ \frac{d(mu)}{dt} - h \frac{dm}{dt} \right] \left( 1 - \frac{T_0}{T_R} \right) - \left[ \frac{d(mu)}{dt} - h \frac{dm}{dt} \right] + m \frac{T_0}{T} \frac{dh}{dt} \\
 &= -\frac{T_0}{T_R} \left[ \frac{d(mu)}{dt} - h \frac{dm}{dt} - m \frac{dh}{dt} \right] \\
 &= -\frac{T_0}{T_R} \left[ c_v \frac{d(mT)}{dt} - c_p T \frac{dm}{dt} - m c_p \frac{dT}{dt} \right]
 \end{aligned}$$

At any time,

$$T = \frac{P\mathcal{V}}{mR}$$

which further reduces this result to

$$\dot{W}_{\text{rev}} = \frac{T_0}{T_R} c_p \frac{P\mathcal{V}}{mR} \frac{dm}{dt} + T_0 m \left( \frac{c_p}{T} \frac{dT}{dt} - \frac{R}{P} \frac{dP}{dt} \right)$$

When this integrated over the time to complete the process, the result is

$$\begin{aligned}
 W_{\text{rev}} &= \frac{T_0}{T_R} \frac{c_p P\mathcal{V}}{R} \ln \frac{m_2}{m_1} + T_0 \frac{c_p P\mathcal{V}}{R} \left( \frac{1}{T_1} - \frac{1}{T_2} \right) \\
 &= \frac{293}{673} \frac{(1.039)(1000)(0.100)}{0.2968} \ln \frac{1}{2} + (293) \frac{(1.039)(1000)(0.100)}{0.2968} \left( \frac{1}{293} - \frac{1}{586} \right) \\
 &= \mathbf{69.4 \text{ kJ}}
 \end{aligned}$$

**8-132** A rigid tank containing nitrogen is considered. Nitrogen is allowed to escape until the mass of nitrogen becomes one-half of its initial mass. The change in the nitrogen's work potential is to be determined.

**Assumptions 1** This is an unsteady process since the conditions within the device are changing during the process. **2** Kinetic and potential energies are negligible. **3** There are no work interactions involved. **4** Nitrogen is an ideal gas with constant specific heats.

**Properties** The properties of nitrogen at room temperature are  $c_p = 1.039$  kJ/kg·K,  $c_v = 0.743$  kJ/kg·K,  $k = 1.4$ , and  $R = 0.2968$  kJ/kg·K (Table A-2a).

**Analysis** The initial and final masses in the tank are

$$m_1 = \frac{P\mathcal{V}}{RT_1} = \frac{(1000 \text{ kPa})(0.100 \text{ m}^3)}{(0.2968 \text{ kPa} \cdot \text{m}^3/\text{kg} \cdot \text{K})(293 \text{ K})} = 1.150 \text{ kg}$$

$$m_2 = m_e = \frac{m_1}{2} = \frac{1.150 \text{ kg}}{2} = 0.575 \text{ kg}$$

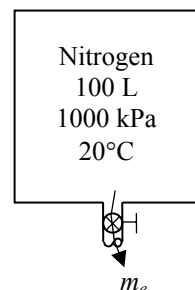

We take the tank as the system, which is a control volume since mass crosses the boundary. Noting that the microscopic energies of flowing and nonflowing fluids are represented by enthalpy  $h$  and internal energy  $u$ , respectively, the mass and energy balances for this uniform-flow system can be expressed as

*Mass balance:*

$$m_{\text{in}} - m_{\text{out}} = \Delta m_{\text{system}} \rightarrow m_e = m_2$$

*Energy balance:*

$$\underbrace{E_{\text{in}} - E_{\text{out}}}_{\text{Net energy transfer by heat, work, and mass}} = \underbrace{\Delta E_{\text{system}}}_{\text{Change in internal, kinetic, potential, etc. energies}}$$

$$-m_e h_e = m_2 u_2 - m_1 u_1$$

Using the average of the initial and final temperatures for the exiting nitrogen, this energy balance equation becomes

$$\begin{aligned} -m_e h_e &= m_2 u_2 - m_1 u_1 \\ -m_e c_p T_e &= m_2 c_v T_2 - m_1 c_v T_1 \\ -(0.575)(1.039)(0.5)(293 + T_2) &= (0.575)(0.743)T_2 - (1.150)(0.743)(293) \end{aligned}$$

Solving for the final temperature, we get

$$T_2 = 224.3 \text{ K}$$

The final pressure in the tank is

$$P_2 = \frac{m_2 R T_2}{\mathcal{V}} = \frac{(0.575 \text{ kg})(0.2968 \text{ kPa} \cdot \text{m}^3/\text{kg} \cdot \text{K})(224.3 \text{ K})}{0.100 \text{ m}^3} = 382.8 \text{ kPa}$$

The average temperature and pressure for the exiting nitrogen is

$$T_e = 0.5(T_1 + T_2) = 0.5(293 + 224.3) = 258.7 \text{ K}$$

$$P_e = 0.5(T_1 + T_2) = 0.5(1000 + 382.8) = 691.4 \text{ kPa}$$

The work potential associated with this process is equal to the exergy destroyed during the process. The exergy destruction during a process can be determined from an exergy balance or directly from its

definition  $X_{\text{destroyed}} = T_0 S_{\text{gen}}$ . The entropy generation  $S_{\text{gen}}$  in this case is determined from an entropy balance on the system:

$$\underbrace{S_{\text{in}} - S_{\text{out}}}_{\substack{\text{Net entropy transfer} \\ \text{by heat and mass}}} + \underbrace{S_{\text{gen}}}_{\substack{\text{Entropy} \\ \text{generation}}} = \underbrace{\Delta S_{\text{system}}}_{\substack{\text{Change} \\ \text{in entropy}}}$$

$$-m_e s_e + S_{\text{gen}} = \Delta S_{\text{tank}} = m_2 s_2 - m_1 s_1$$

$$S_{\text{gen}} = m_2 s_2 - m_1 s_1 + m_e s_e$$

Rearranging and substituting gives

$$\begin{aligned} S_{\text{gen}} &= m_2 s_2 - m_1 s_1 + m_e s_e \\ &= m_2 (c_p \ln T_2 - R \ln P_2) - m_1 (c_p \ln T_1 - R \ln P_1) + m_e (c_p \ln T_e - R \ln P_e) \\ &= (0.575)[1.039 \ln(224.3) - (0.2968) \ln(382.8)] - (1.15)[1.039 \ln(293) - (0.2968) \ln(1000)] \\ &\quad + (0.575)[1.039 \ln(258.7) - (0.2968) \ln(691.4)] \\ &= 2.2188 - 4.4292 + 2.2032 = -0.007152 \text{ kJ/K} \end{aligned}$$

Then,

$$W_{\text{rev}} = X_{\text{destroyed}} = T_0 S_{\text{gen}} = (293 \text{ K})(-0.007152 \text{ kJ/K}) = \mathbf{-2.10 \text{ kJ}}$$

The entropy generation cannot be negative for a thermodynamically possible process. This result is probably due to using average temperature and pressure values for the exiting gas and using constant specific heats for nitrogen. This sensitivity occurs because the entropy generation is very small in this process.

### *Alternative More Accurate Solution*

This problem may also be solved by considering the variation of gas temperature and pressure at the outlet of the tank. The mass balance in this case is

$$\dot{m}_e = -\frac{dm}{dt}$$

which when combined with the reduced first law gives

$$\frac{d(mu)}{dt} = h \frac{dm}{dt}$$

Using the specific heats and the ideal gas equation of state reduces this to

$$c_v \frac{V}{R} \frac{dP}{dt} = c_p T \frac{dm}{dt}$$

which upon rearrangement and an additional use of ideal gas equation of state becomes

$$\frac{1}{P} \frac{dP}{dt} = \frac{c_p}{c_v} \frac{1}{m} \frac{dm}{dt}$$

When this is integrated, the result is

$$P_2 = P_1 \left( \frac{m_2}{m_1} \right)^k = 1000 \left( \frac{1}{2} \right)^{1.4} = 378.9 \text{ kPa}$$

The final temperature is then

$$T_2 = \frac{P_2 V}{m_2 R} = \frac{(378.9 \text{ kPa})(0.100 \text{ m}^3)}{(0.575 \text{ kg})(0.2968 \text{ kPa} \cdot \text{m}^3/\text{kg} \cdot \text{K})} = 222.0 \text{ K}$$

The process is then one of

$$\frac{m^k}{P} = \text{const} \quad \text{or} \quad \frac{m^{k-1}}{T} = \text{const}$$

The reduced combined first and second law becomes

$$\dot{W}_{\text{rev}} = -\frac{d(U - T_0 S)}{dt} + (h - T_0 s) \frac{dm}{dt}$$

when the mass balance is substituted and the entropy generation is set to zero (for maximum work production). Replacing the enthalpy term with the first law result and canceling the common  $dU/dt$  term reduces this to

$$\dot{W}_{\text{rev}} = T_0 \frac{d(ms)}{dt} - T_0 s \frac{dm}{dt}$$

Expanding the first derivative and canceling the common terms further reduces this to

$$\dot{W}_{\text{rev}} = T_0 m \frac{ds}{dt}$$

Letting  $a = P_1 / m_1^k$  and  $b = T_1 / m_1^{k-1}$ , the pressure and temperature of the nitrogen in the system are related to the mass by

$$P = am^k \quad \text{and} \quad T = bm^{k-1}$$

according to the first law. Then,

$$dP = akm^{k-1} dm \quad \text{and} \quad dT = b(k-1)m^{k-2} dm$$

The entropy change relation then becomes

$$ds = c_p \frac{dT}{T} - R \frac{dP}{P} = [(k-1)c_p - Rk] \frac{dm}{m}$$

Now, multiplying the combined first and second laws by  $dt$  and integrating the result gives

$$\begin{aligned} W_{\text{rev}} &= T_0 \int_1^2 m ds = T_0 \int_1^2 m ds [(k-1)c_p - Rk] \frac{dm}{m} \\ &= T_0 [(k-1)c_p - Rk] (m_2 - m_1) \\ &= (293) [(1.4-1)(1.039) - (0.2968)(1.4)] (0.575 - 1.15) \\ &= \mathbf{-0.0135 \text{ kJ}} \end{aligned}$$

Once again the entropy generation is negative, which cannot be the case for a thermodynamically possible process. This is probably due to using constant specific heats for nitrogen. This sensitivity occurs because the entropy generation is very small in this process.

**8-133** A system consisting of a compressor, a storage tank, and a turbine as shown in the figure is considered. The change in the exergy of the air in the tank and the work required to compress the air as the tank was being filled are to be determined.

**Assumptions** 1 Changes in the kinetic and potential energies are negligible. 4 Air is an ideal gas with constant specific heats.

**Properties** The properties of air at room temperature are  $R = 0.287 \text{ kPa}\cdot\text{m}^3/\text{kg}\cdot\text{K}$ ,  $c_p = 1.005 \text{ kJ/kg}\cdot\text{K}$ ,  $c_v = 0.718 \text{ kJ/kg}\cdot\text{K}$ ,  $k = 1.4$  (Table A-2a).

**Analysis** The initial mass of air in the tank is

$$m_{\text{initial}} = \frac{P_{\text{initial}} \mathcal{V}}{RT_{\text{initial}}} = \frac{(100 \text{ kPa})(5 \times 10^5 \text{ m}^3)}{(0.287 \text{ kPa}\cdot\text{m}^3/\text{kg}\cdot\text{K})(293 \text{ K})} = 0.5946 \times 10^6 \text{ kg}$$

and the final mass in the tank is

$$m_{\text{final}} = \frac{P_{\text{final}} \mathcal{V}}{RT_{\text{final}}} = \frac{(600 \text{ kPa})(5 \times 10^5 \text{ m}^3)}{(0.287 \text{ kPa}\cdot\text{m}^3/\text{kg}\cdot\text{K})(293 \text{ K})} = 3.568 \times 10^6 \text{ kg}$$

Since the compressor operates as an isentropic device,

$$T_2 = T_1 \left( \frac{P_2}{P_1} \right)^{(k-1)/k}$$

The conservation of mass applied to the tank gives

$$\frac{dm}{dt} = \dot{m}_{\text{in}}$$

while the first law gives

$$\dot{Q} = \frac{d(mu)}{dt} - h \frac{dm}{dt}$$

Employing the ideal gas equation of state and using constant specific heats, expands this result to

$$\dot{Q} = \frac{\mathcal{V}c_v}{R} \frac{dP}{dt} - c_p T_2 \frac{\mathcal{V}}{RT} \frac{dP}{dt}$$

Using the temperature relation across the compressor and multiplying by  $dt$  puts this result in the form

$$\dot{Q} dt = \frac{\mathcal{V}c_v}{R} dP - c_p T_1 \left( \frac{P}{P_1} \right)^{(k-1)/k} \frac{\mathcal{V}}{RT} dP$$

When this integrated, it yields ( $i$  and  $f$  stand for initial and final states)

$$\begin{aligned} Q &= \frac{\mathcal{V}c_v}{R} (P_f - P_i) - \frac{k}{2k-1} \frac{c_p \mathcal{V}}{R} \left[ P_f \left( \frac{P_f}{P_i} \right)^{(k-1)/k} - P_i \right] \\ &= \frac{(5 \times 10^5)(0.718)}{0.287} (600 - 100) - \frac{1.4}{2(1.4) - 1} \frac{(1.005)(5 \times 10^5)}{0.287} \left[ 600 \left( \frac{600}{100} \right)^{0.4/1.4} - 100 \right] \\ &= -6.017 \times 10^8 \text{ kJ} \end{aligned}$$

The negative result show that heat is transferred from the tank. Applying the first law to the tank and compressor gives

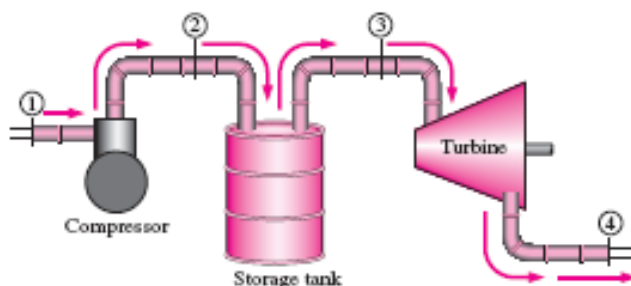

$$(\dot{Q} - \dot{W}_{\text{out}})dt = d(mu) - h_1 dm$$

which integrates to

$$Q - W_{\text{out}} = (m_f u_f - m_i u_i) - h_1 (m_f - m_i)$$

Upon rearrangement,

$$\begin{aligned} W_{\text{out}} &= Q + (c_p - c_v)T(m_f - m_i) \\ &= -6.017 \times 10^8 + (1.005 - 0.718)(293)[(3.568 - 0.5946) \times 10^6] \\ &= \mathbf{-3.516 \times 10^8 \text{ kJ}} \end{aligned}$$

The negative sign shows that work is done on the compressor. When the combined first and second laws is reduced to fit the compressor and tank system and the mass balance incorporated, the result is

$$\dot{W}_{\text{rev}} = \dot{Q} \left( 1 - \frac{T_0}{T_R} \right) - \frac{d(U - T_0 S)}{dt} + (h - T_0 s) \frac{dm}{dt}$$

which when integrated over the process becomes

$$\begin{aligned} W_{\text{rev}} &= Q \left( 1 - \frac{T_0}{T_R} \right) + m_i [(u_i - h_1) - T_0 (s_i - s_1)] - m_f [(u_f - h_1) - T_0 (s_f - s_1)] \\ &= -6.017 \times 10^8 \left( 1 - \frac{293}{293} \right) + 0.5946 \times 10^6 [(0.718 - 1.005)293] \\ &\quad - 3.568 \times 10^6 [(0.718 - 1.005)293] \left[ (0.718 - 1.005)293 + 293(0.287) \ln \frac{600}{100} \right] \\ &= \mathbf{-2.876 \times 10^8 \text{ kJ}} \end{aligned}$$

This is the exergy change of the air stored in the tank.

**8-134** The air stored in the tank of the system shown in the figure is released through the isentropic turbine. The work produced and the change in the exergy of the air in the tank are to be determined.

**Assumptions 1** Changes in the kinetic and potential energies are negligible. **4** Air is an ideal gas with constant specific heats.

**Properties** The properties of air at room temperature are  $R = 0.287 \text{ kPa}\cdot\text{m}^3/\text{kg}\cdot\text{K}$ ,  $c_p = 1.005 \text{ kJ}/\text{kg}\cdot\text{K}$ ,  $c_v = 0.718 \text{ kJ}/\text{kg}\cdot\text{K}$ ,  $k = 1.4$  (Table A-2a).

**Analysis** The initial mass of air in the tank is

$$m_{\text{initial}} = \frac{P_{\text{initial}}\mathcal{V}}{RT_{\text{initial}}} = \frac{(600 \text{ kPa})(5 \times 10^5 \text{ m}^3)}{(0.287 \text{ kPa}\cdot\text{m}^3/\text{kg}\cdot\text{K})(293 \text{ K})} = 3.568 \times 10^6 \text{ kg}$$

and the final mass in the tank is

$$m_{\text{final}} = \frac{P_{\text{final}}\mathcal{V}}{RT_{\text{final}}} = \frac{(100 \text{ kPa})(5 \times 10^5 \text{ m}^3)}{(0.287 \text{ kPa}\cdot\text{m}^3/\text{kg}\cdot\text{K})(293 \text{ K})} = 0.5946 \times 10^6 \text{ kg}$$

The conservation of mass is

$$\frac{dm}{dt} = \dot{m}_{\text{in}}$$

while the first law gives

$$\dot{Q} = \frac{d(mu)}{dt} - h \frac{dm}{dt}$$

Employing the ideal gas equation of state and using constant specific heats, expands this result to

$$\begin{aligned} \dot{Q} &= \frac{\mathcal{V}c_v}{R} \frac{dP}{dt} - c_p T \frac{\mathcal{V}}{RT} \frac{dP}{dt} \\ &= \frac{c_v - c_p}{R} \mathcal{V} \frac{dP}{dt} \\ &= -\mathcal{V} \frac{dP}{dt} \end{aligned}$$

When this is integrated over the process, the result is ( $i$  and  $f$  stand for initial and final states)

$$Q = -\mathcal{V}(P_f - P_i) = -5 \times 10^5 (100 - 600) = 2.5 \times 10^8 \text{ kJ}$$

Applying the first law to the tank and compressor gives

$$(\dot{Q} - \dot{W}_{\text{out}})dt = d(mu) - hdm$$

which integrates to

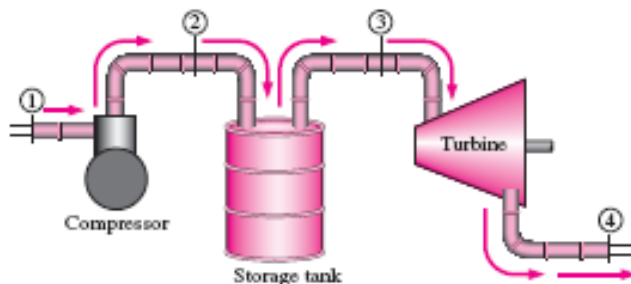

$$\begin{aligned}
Q - W_{\text{out}} &= (m_f u_f - m_i u_i) + h(m_i - m_f) \\
-W_{\text{out}} &= -Q + m_f u_f - m_i u_i + h(m_i - m_f) \\
W_{\text{out}} &= Q - m_f u_f + m_i u_i - h(m_i - m_f) \\
&= Q - m_f c_v T + m_i c_p T - c_p T(m_i - m_f) \\
&= 2.5 \times 10^8 - (0.5946 \times 10^6)(0.718)(293) + (3.568 \times 10^6)(1.005)(293) \\
&\quad - (1.005)(293)(3.568 \times 10^6 - 0.5946 \times 10^6) \\
&= \mathbf{3.00 \times 10^8 \text{ kJ}}
\end{aligned}$$

This is the work output from the turbine. When the combined first and second laws is reduced to fit the turbine and tank system and the mass balance incorporated, the result is

$$\begin{aligned}
\dot{W}_{\text{rev}} &= \dot{Q} \left( 1 - \frac{T_0}{T_R} \right) - \frac{d(U - T_0 S)}{dt} + (h - T_0 s) \frac{dm}{dt} \\
&= \dot{Q} \left( 1 - \frac{T_0}{T_R} \right) - (u - T_0 s) \frac{dm}{dt} - m \frac{d(u - T_0 s)}{dt} + (h - T_0 s) \frac{dm}{dt} \\
&= \dot{Q} \left( 1 - \frac{T_0}{T_R} \right) + (c_p - c_v) T \frac{dm}{dt} + m T_0 \frac{ds}{dt} \\
&= \dot{Q} \left( 1 - \frac{T_0}{T_R} \right) + (c_p - c_v) T \frac{dm}{dt} - \mathcal{V} \frac{T_0}{T} (P_f - P_i)
\end{aligned}$$

where the last step uses entropy change equation. When this is integrated over the process it becomes

$$\begin{aligned}
W_{\text{rev}} &= Q \left( 1 - \frac{T_0}{T_R} \right) + (c_p - c_v) T (m_f - m_i) - \mathcal{V} \frac{T_0}{T} (P_f - P_i) \\
&= 3.00 \times 10^8 \left( 1 - \frac{293}{293} \right) + (1.005 - 0.718)(293)(0.5946 - 3.568) \times 10^6 - 5 \times 10^5 \frac{293}{293} (100 - 600) \\
&= 0 - 2.500 \times 10^8 - 2.5 \times 10^8 \\
&= \mathbf{-5.00 \times 10^8 \text{ kJ}}
\end{aligned}$$

This is the exergy change of the air in the storage tank.



**8-135** A heat engine operates between a tank and a cylinder filled with air at different temperatures. The maximum work that can be produced and the final temperatures are to be determined.

**Assumptions** Air is an ideal gas with constant specific heats at room temperature.

**Properties** The specific heats of air are  $c_v = 0.718 \text{ kJ/kg}\cdot\text{K}$  and  $c_p = 1.005 \text{ kJ/kg}\cdot\text{K}$  (Table A-2).

**Analysis** For maximum power production, the entropy generation must be zero. We take the tank, the cylinder (the heat source and the heat sink) and the heat engine as the system. Noting that the system involves no heat and mass transfer and that the entropy change for cyclic devices is zero, the entropy balance can be expressed as

$$\underbrace{S_{\text{in}} - S_{\text{out}}}_{\text{Net entropy transfer by heat and mass}} + \underbrace{S_{\text{gen}}}_{\text{Entropy generation}} \stackrel{\approx 0}{=} \underbrace{\Delta S_{\text{system}}}_{\text{Change in entropy}}$$

$$0 + S_{\text{gen}} \stackrel{\approx 0}{=} \Delta S_{\text{tank,source}} + \Delta S_{\text{cylinder,sink}} + \Delta S_{\text{heat engine}} \stackrel{\approx 0}{=} 0$$

$$(\Delta S)_{\text{source}} + (\Delta S)_{\text{sink}} = 0$$

$$\left( mc_v \ln \frac{T_2}{T_{1A}} - mR \ln \frac{V_2}{V_1} \right)_{\text{source}} + 0 + \left( mc_p \ln \frac{T_2}{T_1} - mR \ln \frac{P_2}{P_1} \right)_{\text{sink}} = 0$$

$$\ln \frac{T_2}{T_{1A}} + \frac{c_p}{c_v} \ln \frac{T_2}{T_{1B}} = 0 \longrightarrow \frac{T_2}{T_{1A}} \left( \frac{T_2}{T_{1B}} \right)^k = 1 \longrightarrow T_2 = (T_{1A} T_{1B}^k)^{1/(k+1)}$$

where  $T_{1A}$  and  $T_{1B}$  are the initial temperatures of the source and the sink, respectively, and  $T_2$  is the common final temperature. Therefore, the final temperature of the tanks for maximum power production is

$$T_2 = \left( (800 \text{ K})(290 \text{ K})^{1.4} \right)^{\frac{1}{2.4}} = \mathbf{442.6 \text{ K}}$$

**Source:**

$$-Q_{\text{source,out}} = \Delta U = mc_v(T_2 - T_{1A}) \rightarrow Q_{\text{source,out}} = mc_v(T_{1A} - T_2)$$

$$Q_{\text{source,out}} = mc_v(T_{1A} - T_2) = (20 \text{ kg})(0.718 \text{ kJ/kg}\cdot\text{K})(800 - 442.6)\text{K} = 5132 \text{ kJ}$$

**Sink:**

$$Q_{\text{sink,in}} - W_{\text{b,out}} = \Delta U \rightarrow Q_{\text{sink,in}} = \Delta H = mc_p(T_2 - T_{1A})$$

$$Q_{\text{sink,in}} = mc_p(T_2 - T_{1A}) = (20 \text{ kg})(1.005 \text{ kJ/kg}\cdot\text{K})(442.6 - 290)\text{K} = 3068 \text{ kJ}$$

Then the work produced becomes

$$W_{\text{max,out}} = Q_H - Q_L = Q_{\text{source,out}} - Q_{\text{sink,in}} = 5132 - 3068 = \mathbf{2064 \text{ kJ}}$$

Therefore, a maximum of 2064 kJ of work can be produced during this process.

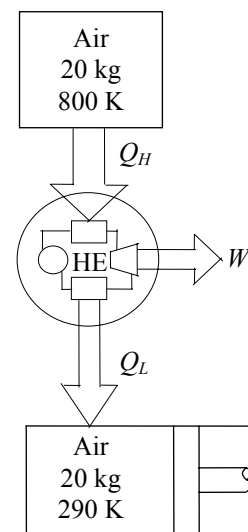

**8-136** Using an incompressible substance as an example, it is to be demonstrated if closed system and flow exergies can be negative.

**Analysis** The availability of a closed system cannot be negative. However, the flow availability can be negative at low pressures. A closed system has zero availability at dead state, and positive availability at any other state since we can always produce work when there is a pressure or temperature differential.

To see that the flow availability can be negative, consider an incompressible substance. The flow availability can be written as

$$\begin{aligned}\psi &= h - h_0 + T_0(s - s_0) \\ &= (u - u_0) + v(P - P_0) + T_0(s - s_0) \\ &= \xi + v(P - P_0)\end{aligned}$$

The closed system availability  $\xi$  is always positive or zero, and the flow availability can be negative when  $P \ll P_0$ .

**8-137** A relation for the second-law efficiency of a heat engine operating between a heat source and a heat sink at specified temperatures is to be obtained.

**Analysis** The second-law efficiency is defined as the ratio of the availability recovered to availability supplied during a process. The work  $W$  produced is the availability recovered. The decrease in the availability of the heat supplied  $Q_H$  is the availability supplied or invested.

Therefore,

$$\eta_{II} = \frac{W}{\left(1 - \frac{T_0}{T_H}\right)Q_H - \left(1 - \frac{T_0}{T_L}\right)(Q_H - W)}$$

Note that the first term in the denominator is the availability of heat supplied to the heat engine whereas the second term is the availability of the heat rejected by the heat engine. The difference between the two is the availability consumed during the process.

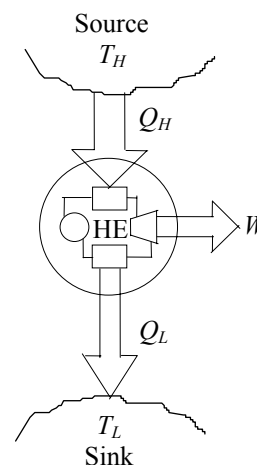

**8-138E** Large brass plates are heated in an oven at a rate of 300/min. The rate of heat transfer to the plates in the oven and the rate of exergy destruction associated with this heat transfer process are to be determined.

**Assumptions** 1 The thermal properties of the plates are constant. 2 The changes in kinetic and potential energies are negligible. 3 The environment temperature is 75°F.

**Properties** The density and specific heat of the brass are given to be  $\rho = 532.5 \text{ lbm/ft}^3$  and  $c_p = 0.091 \text{ Btu/lbm}\cdot^\circ\text{F}$ .

**Analysis** We take the plate to be the system. The energy balance for this closed system can be expressed as

$$\underbrace{E_{\text{in}} - E_{\text{out}}}_{\substack{\text{Net energy transfer} \\ \text{by heat, work, and mass}}} = \underbrace{\Delta E_{\text{system}}}_{\substack{\text{Change in internal, kinetic,} \\ \text{potential, etc. energies}}}$$

$$Q_{\text{in}} = \Delta U_{\text{plate}} = m(u_2 - u_1) = mc(T_2 - T_1)$$

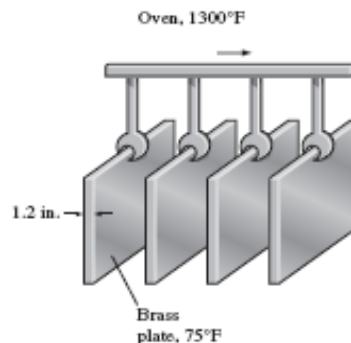

The mass of each plate and the amount of heat transfer to each plate is

$$m = \rho V = \rho LA = (532.5 \text{ lbm/ft}^3)[(1.2/12 \text{ ft})(2 \text{ ft})(2 \text{ ft})] = 213 \text{ lbm}$$

$$Q_{\text{in}} = mc(T_2 - T_1) = (213 \text{ lbm/plate})(0.091 \text{ Btu/lbm}\cdot^\circ\text{F})(1000 - 75)^\circ\text{F} = 17,930 \text{ Btu/plate}$$

Then the total rate of heat transfer to the plates becomes

$$\dot{Q}_{\text{total}} = \dot{n}_{\text{plate}} Q_{\text{in, per plate}} = (300 \text{ plates/min}) \times (17,930 \text{ Btu/plate}) = \mathbf{5,379,000 \text{ Btu/min} = 89,650 \text{ Btu/s}}$$

We again take a single plate as the system. The entropy generated during this process can be determined by applying an entropy balance on an *extended system* that includes the plate and its immediate surroundings so that the boundary temperature of the extended system is at 1300°F at all times:

$$\underbrace{S_{\text{in}} - S_{\text{out}}}_{\substack{\text{Net entropy transfer} \\ \text{by heat and mass}}} + \underbrace{S_{\text{gen}}}_{\substack{\text{Entropy} \\ \text{generation}}} = \underbrace{\Delta S_{\text{system}}}_{\substack{\text{Change} \\ \text{in entropy}}}$$

$$\frac{Q_{\text{in}}}{T_b} + S_{\text{gen}} = \Delta S_{\text{system}} \rightarrow S_{\text{gen}} = -\frac{Q_{\text{in}}}{T_b} + \Delta S_{\text{system}}$$

where

$$\Delta S_{\text{system}} = m(s_2 - s_1) = mc_{\text{avg}} \ln \frac{T_2}{T_1} = (213 \text{ lbm})(0.091 \text{ Btu/lbm}\cdot\text{R}) \ln \frac{(1000 + 460) \text{ R}}{(75 + 460) \text{ R}} = 19.46 \text{ Btu/R}$$

Substituting,

$$S_{\text{gen}} = -\frac{Q_{\text{in}}}{T_b} + \Delta S_{\text{system}} = -\frac{17,930 \text{ Btu}}{1300 + 460 \text{ R}} + 19.46 \text{ Btu/R} = 9.272 \text{ Btu/R (per plate)}$$

Then the rate of entropy generation becomes

$$\dot{S}_{\text{gen}} = S_{\text{gen}} \dot{n}_{\text{plate}} = (9.272 \text{ Btu/R} \cdot \text{plate})(300 \text{ plates/min}) = 2781 \text{ Btu/min}\cdot\text{R} = 46.35 \text{ Btu/s}\cdot\text{R}$$

The exergy destroyed during a process can be determined from an exergy balance or directly from its definition  $X_{\text{destroyed}} = T_0 S_{\text{gen}}$ ,

$$\dot{X}_{\text{destroyed}} = T_0 \dot{S}_{\text{gen}} = (535 \text{ R})(46.35 \text{ Btu/s}\cdot\text{R}) = \mathbf{24,797 \text{ Btu/s}}$$

**8-139** Long cylindrical steel rods are heat-treated in an oven. The rate of heat transfer to the rods in the oven and the rate of exergy destruction associated with this heat transfer process are to be determined.

**Assumptions 1** The thermal properties of the rods are constant. **2** The changes in kinetic and potential energies are negligible. **3** The environment temperature is 30°C.

**Properties** The density and specific heat of the steel rods are given to be  $\rho = 7833 \text{ kg/m}^3$  and  $c_p = 0.465 \text{ kJ/kg}\cdot^\circ\text{C}$ .

**Analysis** Noting that the rods enter the oven at a velocity of 3 m/min and exit at the same velocity, we can say that a 3-m long section of the rod is heated in the oven in 1 min. Then the mass of the rod heated in 1 minute is

$$m = \rho V = \rho LA = \rho L(\pi D^2 / 4) = (7833 \text{ kg/m}^3)(3 \text{ m})[\pi(0.1 \text{ m})^2 / 4] = 184.6 \text{ kg}$$

We take the 3-m section of the rod in the oven as the system. The energy balance for this closed system can be expressed as

$$\underbrace{E_{\text{in}} - E_{\text{out}}}_{\substack{\text{Net energy transfer} \\ \text{by heat, work, and mass}}} = \underbrace{\Delta E_{\text{system}}}_{\substack{\text{Change in internal, kinetic,} \\ \text{potential, etc. energies}}}$$

$$Q_{\text{in}} = \Delta U_{\text{rod}} = m(u_2 - u_1) = mc(T_2 - T_1)$$

Substituting,

$$Q_{\text{in}} = mc(T_2 - T_1) = (184.6 \text{ kg})(0.465 \text{ kJ/kg}\cdot^\circ\text{C})(700 - 30)^\circ\text{C} = 57,512 \text{ kJ}$$

Noting that this much heat is transferred in 1 min, the rate of heat transfer to the rod becomes

$$\dot{Q}_{\text{in}} = Q_{\text{in}} / \Delta t = (57,512 \text{ kJ}) / (1 \text{ min}) = 57,512 \text{ kJ/min} = \mathbf{958.5 \text{ kW}}$$

We again take the 3-m long section of the rod as the system. The entropy generated during this process can be determined by applying an entropy balance on an *extended system* that includes the rod and its immediate surroundings so that the boundary temperature of the extended system is at 900°C at all times:

$$\underbrace{S_{\text{in}} - S_{\text{out}}}_{\substack{\text{Net entropy transfer} \\ \text{by heat and mass}}} + \underbrace{S_{\text{gen}}}_{\substack{\text{Entropy} \\ \text{generation}}} = \underbrace{\Delta S_{\text{system}}}_{\substack{\text{Change} \\ \text{in entropy}}}$$

$$\frac{Q_{\text{in}}}{T_b} + S_{\text{gen}} = \Delta S_{\text{system}} \rightarrow S_{\text{gen}} = -\frac{Q_{\text{in}}}{T_b} + \Delta S_{\text{system}}$$

where

$$\Delta S_{\text{system}} = m(s_2 - s_1) = mc_{\text{avg}} \ln \frac{T_2}{T_1} = (184.6 \text{ kg})(0.465 \text{ kJ/kg}\cdot\text{K}) \ln \frac{700 + 273}{30 + 273} = 100.1 \text{ kJ/K}$$

Substituting,

$$S_{\text{gen}} = -\frac{Q_{\text{in}}}{T_b} + \Delta S_{\text{system}} = -\frac{57,512 \text{ kJ}}{(900 + 273) \text{ R}} + 100.1 \text{ kJ/K} = 51.1 \text{ kJ/K}$$

Noting that this much entropy is generated in 1 min, the rate of entropy generation becomes

$$\dot{S}_{\text{gen}} = \frac{S_{\text{gen}}}{\Delta t} = \frac{51.1 \text{ kJ/K}}{1 \text{ min}} = 51.1 \text{ kJ/min}\cdot\text{K} = 0.852 \text{ kW/K}$$

The exergy destroyed during a process can be determined from an exergy balance or directly from its definition  $X_{\text{destroyed}} = T_0 S_{\text{gen}}$ ,

$$\dot{X}_{\text{destroyed}} = T_0 \dot{S}_{\text{gen}} = (298 \text{ K})(0.852 \text{ kW/K}) = \mathbf{254 \text{ kW}}$$

**8-140** Steam is condensed by cooling water in the condenser of a power plant. The rate of condensation of steam and the rate of exergy destruction are to be determined.

**Assumptions** **1** Steady operating conditions exist. **2** The heat exchanger is well-insulated so that heat loss to the surroundings is negligible and thus heat transfer from the hot fluid is equal to the heat transfer to the cold fluid. **3** Changes in the kinetic and potential energies of fluid streams are negligible. **4** Fluid properties are constant.

**Properties** The enthalpy and entropy of vaporization of water at 60°C are  $h_{fg} = 2357.7$  kJ/kg and  $s_{fg} = 7.0769$  kJ/kg.K (Table A-4). The specific heat of water at room temperature is  $c_p = 4.18$  kJ/kg.°C (Table A-3).

**Analysis** (a) We take the cold water tubes as the system, which is a control volume. The energy balance for this steady-flow system can be expressed in the rate form as

$$\underbrace{\dot{E}_{in} - \dot{E}_{out}}_{\text{Rate of net energy transfer by heat, work, and mass}} = \underbrace{\dot{\Delta E}_{system}}_{\text{Rate of change in internal, kinetic, potential, etc. energies}} \stackrel{\approx 0 \text{ (steady)}}{=} 0$$

$$\dot{E}_{in} = \dot{E}_{out}$$

$$\dot{Q}_{in} + \dot{m}h_1 = \dot{m}h_2 \quad (\text{since } \Delta ke \cong \Delta pe \cong 0)$$

$$\dot{Q}_{in} = \dot{m}C_p(T_2 - T_1)$$

Then the heat transfer rate to the cooling water in the condenser becomes

$$\begin{aligned} \dot{Q} &= [\dot{m}C_p(T_{out} - T_{in})]_{\text{cooling water}} \\ &= (140 \text{ kg/s})(4.18 \text{ kJ/kg}\cdot\text{°C})(25\text{°C} - 15\text{°C}) = 5852 \text{ kJ/s} \end{aligned}$$

The rate of condensation of steam is determined to be

$$\dot{Q} = (\dot{m}h_{fg})_{\text{steam}} \longrightarrow \dot{m}_{\text{steam}} = \frac{\dot{Q}}{h_{fg}} = \frac{5852 \text{ kJ/s}}{2357.7 \text{ kJ/kg}} = \mathbf{2.482 \text{ kg/s}}$$

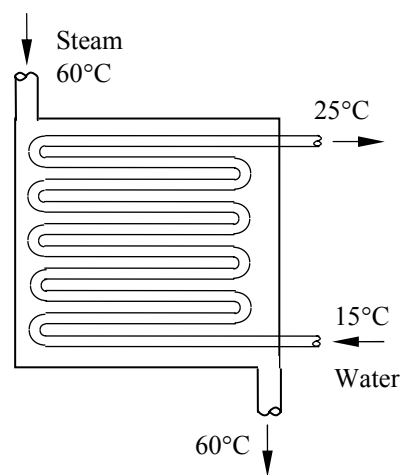

(b) The rate of entropy generation within the condenser during this process can be determined by applying the rate form of the entropy balance on the entire condenser. Noting that the condenser is well-insulated and thus heat transfer is negligible, the entropy balance for this steady-flow system can be expressed as

$$\underbrace{\dot{S}_{in} - \dot{S}_{out}}_{\text{Rate of net entropy transfer by heat and mass}} + \underbrace{\dot{S}_{gen}}_{\text{Rate of entropy generation}} = \underbrace{\dot{\Delta S}_{system}}_{\text{Rate of change of entropy}} \stackrel{\approx 0 \text{ (steady)}}{=}$$

$$\dot{m}_1s_1 + \dot{m}_3s_3 - \dot{m}_2s_2 - \dot{m}_4s_4 + \dot{S}_{gen} = 0 \quad (\text{since } \dot{Q} = 0)$$

$$\dot{m}_{\text{water}}s_1 + \dot{m}_{\text{steam}}s_3 - \dot{m}_{\text{water}}s_2 - \dot{m}_{\text{steam}}s_4 + \dot{S}_{gen} = 0$$

$$\dot{S}_{gen} = \dot{m}_{\text{water}}(s_2 - s_1) + \dot{m}_{\text{steam}}(s_4 - s_3)$$

Noting that water is an incompressible substance and steam changes from saturated vapor to saturated liquid, the rate of entropy generation is determined to be

$$\begin{aligned} \dot{S}_{gen} &= \dot{m}_{\text{water}}c_p \ln \frac{T_2}{T_1} + \dot{m}_{\text{steam}}(s_f - s_g) = \dot{m}_{\text{water}}c_p \ln \frac{T_2}{T_1} - \dot{m}_{\text{steam}}s_{fg} \\ &= (140 \text{ kg/s})(4.18 \text{ kJ/kg}\cdot\text{K}) \ln \frac{25 + 273}{15 + 273} - (2.482 \text{ kg/s})(7.0769 \text{ kJ/kg}\cdot\text{K}) = 2.409 \text{ kW/K} \end{aligned}$$

Then the exergy destroyed can be determined directly from its definition  $X_{\text{destroyed}} = T_0\dot{S}_{gen}$  to be

$$\dot{X}_{\text{destroyed}} = T_0\dot{S}_{gen} = (288 \text{ K})(2.409 \text{ kW/K}) = \mathbf{694 \text{ kW}}$$

**8-141** Water is heated in a heat exchanger by geothermal water. The rate of heat transfer to the water and the rate of exergy destruction within the heat exchanger are to be determined.

**Assumptions** **1** Steady operating conditions exist. **2** The heat exchanger is well-insulated so that heat loss to the surroundings is negligible and thus heat transfer from the hot fluid is equal to the heat transfer to the cold fluid. **3** Changes in the kinetic and potential energies of fluid streams are negligible. **4** Fluid properties are constant. **5** The environment temperature is 25°C.

**Properties** The specific heats of water and geothermal fluid are given to be 4.18 and 4.31 kJ/kg·°C, respectively.

**Analysis (a)** We take the cold water tubes as the system, which is a control volume. The energy balance for this steady-flow system can be expressed in the rate form as

$$\underbrace{\dot{E}_{\text{in}} - \dot{E}_{\text{out}}}_{\text{Rate of net energy transfer by heat, work, and mass}} = \underbrace{\Delta \dot{E}_{\text{system}}}_{\text{Rate of change in internal, kinetic, potential, etc. energies}} \stackrel{\approx 0 \text{ (steady)}}{=} 0$$

$$\dot{E}_{\text{in}} = \dot{E}_{\text{out}}$$

$$\dot{Q}_{\text{in}} + \dot{m}h_1 = \dot{m}h_2 \quad (\text{since } \Delta ke \cong \Delta pe \cong 0)$$

$$\dot{Q}_{\text{in}} = \dot{m}c_p(T_2 - T_1)$$

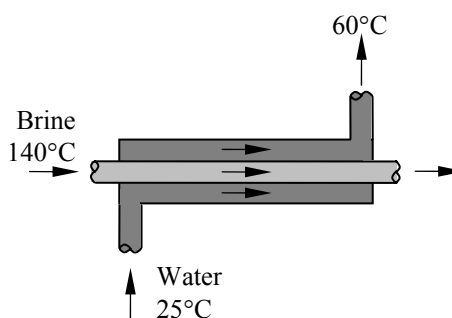

Then the rate of heat transfer to the cold water in the heat exchanger becomes

$$\dot{Q}_{\text{in,water}} = [\dot{m}c_p(T_{\text{out}} - T_{\text{in}})]_{\text{water}} = (0.4 \text{ kg/s})(4.18 \text{ kJ/kg}\cdot\text{°C})(60\text{°C} - 25\text{°C}) = \mathbf{58.52 \text{ kW}}$$

Noting that heat transfer to the cold water is equal to the heat loss from the geothermal water, the outlet temperature of the geothermal water is determined from

$$\dot{Q}_{\text{out}} = [\dot{m}c_p(T_{\text{in}} - T_{\text{out}})]_{\text{geo}} \longrightarrow T_{\text{out}} = T_{\text{in}} - \frac{\dot{Q}_{\text{out}}}{\dot{m}c_p} = 140\text{°C} - \frac{58.52 \text{ kW}}{(0.3 \text{ kg/s})(4.31 \text{ kJ/kg}\cdot\text{°C})} = 94.7\text{°C}$$

(b) The rate of entropy generation within the heat exchanger is determined by applying the rate form of the entropy balance on the entire heat exchanger:

$$\underbrace{\dot{S}_{\text{in}} - \dot{S}_{\text{out}}}_{\text{Rate of net entropy transfer by heat and mass}} + \underbrace{\dot{S}_{\text{gen}}}_{\text{Rate of entropy generation}} = \underbrace{\Delta \dot{S}_{\text{system}}}_{\text{Rate of change of entropy}} \stackrel{\approx 0 \text{ (steady)}}{=} 0$$

$$\dot{m}_1 s_1 + \dot{m}_3 s_3 - \dot{m}_2 s_2 - \dot{m}_4 s_4 + \dot{S}_{\text{gen}} = 0 \quad (\text{since } \dot{Q} = 0)$$

$$\dot{m}_{\text{water}} s_1 + \dot{m}_{\text{geo}} s_3 - \dot{m}_{\text{water}} s_2 - \dot{m}_{\text{geo}} s_4 + \dot{S}_{\text{gen}} = 0$$

$$\dot{S}_{\text{gen}} = \dot{m}_{\text{water}}(s_2 - s_1) + \dot{m}_{\text{geo}}(s_4 - s_3)$$

Noting that both fresh and geothermal water are incompressible substances, the rate of entropy generation is determined to be

$$\dot{S}_{\text{gen}} = \dot{m}_{\text{water}} c_p \ln \frac{T_2}{T_1} + \dot{m}_{\text{geo}} c_p \ln \frac{T_4}{T_3}$$

$$= (0.4 \text{ kg/s})(4.18 \text{ kJ/kg}\cdot\text{K}) \ln \frac{60 + 273}{25 + 273} + (0.3 \text{ kg/s})(4.31 \text{ kJ/kg}\cdot\text{K}) \ln \frac{94.7 + 273}{140 + 273} = 0.0356 \text{ kW/K}$$

The exergy destroyed during a process can be determined from an exergy balance or directly from its definition  $\dot{X}_{\text{destroyed}} = T_0 \dot{S}_{\text{gen}}$ ,

$$\dot{X}_{\text{destroyed}} = T_0 \dot{S}_{\text{gen}} = (298 \text{ K})(0.0356 \text{ kW/K}) = \mathbf{10.61 \text{ kW}}$$

**8-142** A regenerator is considered to save heat during the cooling of milk in a dairy plant. The amounts of fuel and money such a generator will save per year and the rate of exergy destruction within the regenerator are to be determined.

**Assumptions 1** Steady operating conditions exist. **2** The properties of the milk are constant. **5** The environment temperature is 18°C.

**Properties** The average density and specific heat of milk can be taken to be  $\rho_{\text{milk}} \cong \rho_{\text{water}} = 1 \text{ kg/L}$  and  $c_{p,\text{milk}} = 3.79 \text{ kJ/kg}\cdot^\circ\text{C}$  (Table A-3).

**Analysis** The mass flow rate of the milk is

$$\dot{m}_{\text{milk}} = \rho \dot{V}_{\text{milk}} = (1 \text{ kg/L})(12 \text{ L/s}) = 12 \text{ kg/s} = 43,200 \text{ kg/h}$$

Taking the pasteurizing section as the system, the energy balance for this steady-flow system can be expressed in the rate form as

$$\underbrace{\dot{E}_{\text{in}} - \dot{E}_{\text{out}}}_{\text{Rate of net energy transfer by heat, work, and mass}} = \underbrace{\Delta \dot{E}_{\text{system}}^{\neq 0} (\text{steady})}_{\text{Rate of change in internal, kinetic, potential, etc. energies}} = 0 \rightarrow \dot{E}_{\text{in}} = \dot{E}_{\text{out}}$$

$$\dot{Q}_{\text{in}} + \dot{m}h_1 = \dot{m}h_2 \quad (\text{since } \Delta ke \cong \Delta pe \cong 0)$$

$$\dot{Q}_{\text{in}} = \dot{m}_{\text{milk}} c_p (T_2 - T_1)$$

Therefore, to heat the milk from 4 to 72°C as being done currently, heat must be transferred to the milk at a rate of

$$\dot{Q}_{\text{current}} = [\dot{m}c_p (T_{\text{pasteurization}} - T_{\text{refrigeration}})]_{\text{milk}} = (12 \text{ kg/s})(3.79 \text{ kJ/kg}\cdot^\circ\text{C})(72 - 4)^\circ\text{C} = 3093 \text{ kJ/s}$$

The proposed regenerator has an effectiveness of  $\varepsilon = 0.82$ , and thus it will save 82 percent of this energy. Therefore,

$$\dot{Q}_{\text{saved}} = \varepsilon \dot{Q}_{\text{current}} = (0.82)(3093 \text{ kJ/s}) = 2536 \text{ kJ/s}$$

Noting that the boiler has an efficiency of  $\eta_{\text{boiler}} = 0.82$ , the energy savings above correspond to fuel savings of

$$\text{Fuel Saved} = \frac{\dot{Q}_{\text{saved}}}{\eta_{\text{boiler}}} = \frac{(2536 \text{ kJ/s})}{(0.82)} \frac{(1 \text{ therm})}{(105,500 \text{ kJ})} = 0.02931 \text{ therm/s}$$

Noting that 1 year = 365×24=8760 h and unit cost of natural gas is \$1.04/therm, the annual fuel and money savings will be

$$\text{Fuel Saved} = (0.02931 \text{ therms/s})(8760 \times 3600 \text{ s}) = \mathbf{924,450 \text{ therms/yr}}$$

$$\text{Money saved} = (\text{Fuel saved})(\text{Unit cost of fuel}) = (924,450 \text{ therm/yr})(\$1.04/\text{therm}) = \mathbf{\$961,430/\text{yr}}$$

The rate of entropy generation during this process is determined by applying the rate form of the entropy balance on an *extended system* that includes the regenerator and the immediate surroundings so that the boundary temperature is the surroundings temperature, which we take to be the cold water temperature of 18°C.:

$$\underbrace{\dot{S}_{\text{in}} - \dot{S}_{\text{out}}}_{\text{Rate of net entropy transfer by heat and mass}} + \underbrace{\dot{S}_{\text{gen}}}_{\text{Rate of entropy generation}} = \underbrace{\Delta \dot{S}_{\text{system}}^{\neq 0} (\text{steady})}_{\text{Rate of change of entropy}} \rightarrow \dot{S}_{\text{gen}} = \dot{S}_{\text{out}} - \dot{S}_{\text{in}}$$

Disregarding entropy transfer associated with fuel flow, the only significant difference between the two cases is the reduction in the entropy transfer to water due to the reduction in heat transfer to water, and is determined to be

$$\dot{S}_{\text{gen, reduction}} = \dot{S}_{\text{out, reduction}} = \frac{\dot{Q}_{\text{out, reduction}}}{T_{\text{surr}}} = \frac{\dot{Q}_{\text{saved}}}{T_{\text{surr}}} = \frac{2536 \text{ kJ/s}}{18 + 273} = 8.715 \text{ kW/K}$$

$$S_{\text{gen, reduction}} = \dot{S}_{\text{gen, reduction}} \Delta t = (8.715 \text{ kJ/s}\cdot\text{K})(8760 \times 3600 \text{ s/year}) = 2.75 \times 10^8 \text{ kJ/K (per year)}$$

The exergy destroyed during a process can be determined from an exergy balance or directly from its definition  $X_{\text{destroyed}} = T_0 S_{\text{gen}}$ ,

$$X_{\text{destroyed, reduction}} = T_0 S_{\text{gen, reduction}} = (291 \text{ K})(2.75 \times 10^8 \text{ kJ/K}) = \mathbf{8.00 \times 10^{10} \text{ kJ (per year)}}$$

**8-143** Exhaust gases are expanded in a turbine, which is not well-insulated. The actual and reversible power outputs, the exergy destroyed, and the second-law efficiency are to be determined.

**Assumptions** 1 Steady operating conditions exist. 2 Potential energy change is negligible. 3 Air is an ideal gas with constant specific heats.

**Properties** The gas constant of air is  $R = 0.287 \text{ kJ/kg}\cdot\text{K}$  and the specific heat of air at the average temperature of  $(750+630)/2 = 690^\circ\text{C}$  is  $c_p = 1.134 \text{ kJ/kg}\cdot^\circ\text{C}$  (Table A-2).

**Analysis** (a) The enthalpy and entropy changes of air across the turbine are

$$\Delta h = c_p (T_1 - T_2) = (1.134 \text{ kJ/kg}\cdot^\circ\text{C})(750 - 630)^\circ\text{C} = 136.08 \text{ kJ/kg}$$

$$\begin{aligned} \Delta s &= c_p \ln \frac{T_1}{T_2} - R \ln \frac{P_1}{P_2} \\ &= (1.134 \text{ kJ/kg}\cdot\text{K}) \ln \frac{(750 + 273) \text{ K}}{(630 + 273) \text{ K}} - (0.287 \text{ kJ/kg}\cdot\text{K}) \ln \frac{1200 \text{ kPa}}{500 \text{ kPa}} \\ &= -0.005354 \text{ kJ/kg}\cdot\text{K} \end{aligned}$$

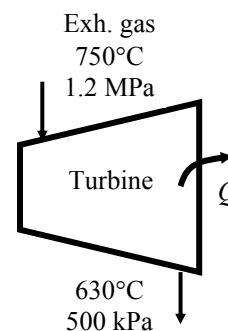

The actual and reversible power outputs from the turbine are

$$\dot{W}_a = \dot{m}\Delta h - \dot{Q}_{\text{out}} = (3.4 \text{ kg/s})(136.08 \text{ kJ/kg}) - 30 \text{ kW} = \mathbf{432.7 \text{ kW}}$$

$$\dot{W}_{\text{rev}} = \dot{m}(\Delta h - T_0 \Delta s) = (3.4 \text{ kg/s})(136.08 \text{ kJ/kg}) - (25 + 273 \text{ K})(-0.005354 \text{ kJ/kg}\cdot\text{K}) = \mathbf{516.9 \text{ kW}}$$

(b) The exergy destroyed in the turbine is

$$\dot{X}_{\text{dest}} = \dot{W}_{\text{rev}} - \dot{W}_a = 516.9 - 432.7 = \mathbf{84.2 \text{ kW}}$$

(c) The second-law efficiency is

$$\eta_{\text{II}} = \frac{\dot{W}_a}{\dot{W}_{\text{rev}}} = \frac{432.7 \text{ kW}}{516.9 \text{ kW}} = \mathbf{0.837}$$



**8-144** Refrigerant-134a is compressed in an adiabatic compressor, whose second-law efficiency is given. The actual work input, the isentropic efficiency, and the exergy destruction are to be determined.

**Assumptions 1** Steady operating conditions exist. **2** Kinetic and potential energy changes are negligible.

**Analysis (a)** The properties of the refrigerant at the inlet of the compressor are (Tables A-11 through A-13)

$$\begin{aligned} T_{\text{sat}@160 \text{ kPa}} &= -15.60^\circ\text{C} \\ P_1 = 160 \text{ kPa} & \quad \left. \begin{array}{l} h_1 = 243.60 \text{ kJ/kg} \\ s_1 = 0.95153 \text{ kJ/kg}\cdot\text{K} \end{array} \right\} \end{aligned}$$

The enthalpy at the exit for if the process was isentropic is

$$\begin{aligned} P_2 = 1 \text{ MPa} & \\ s_2 = s_1 = 0.95153 \text{ kJ/kg}\cdot\text{K} & \quad \left. \right\} h_{2s} = 282.41 \text{ kJ/kg} \end{aligned}$$

The expressions for actual and reversible works are

$$w_a = h_2 - h_1 = (h_2 - 243.60) \text{ kJ/kg}$$

$$w_{\text{rev}} = h_2 - h_1 - T_0(s_2 - s_1) = (h_2 - 243.60) \text{ kJ/kg} - (25 + 273 \text{ K})(s_2 - 0.95153) \text{ kJ/kg}\cdot\text{K}$$

Substituting these into the expression for the second-law efficiency

$$\eta_{\text{II}} = \frac{w_{\text{rev}}}{w_a} \longrightarrow 0.80 = \frac{h_2 - 243.60 - (298)(s_2 - 0.95153)}{h_2 - 243.60}$$

The exit pressure is given (1 MPa). We need one more property to fix the exit state. By a trial-error approach or using EES, we obtain the exit temperature to be  $60^\circ\text{C}$ . The corresponding enthalpy and entropy values satisfying this equation are

$$h_2 = 293.36 \text{ kJ/kg}$$

$$s_2 = 0.98492 \text{ kJ/kg}\cdot\text{K}$$

Then,

$$w_a = h_2 - h_1 = 293.36 - 243.60 = \mathbf{49.76 \text{ kJ/kg}}$$

$$w_{\text{rev}} = h_2 - h_1 - T_0(s_2 - s_1) = (293.36 - 243.60) \text{ kJ/kg} - (25 + 273 \text{ K})(0.98492 - 0.9515) \text{ kJ/kg}\cdot\text{K} = 39.81 \text{ kJ/kg}$$

(b) The isentropic efficiency is determined from its definition

$$\eta_s = \frac{h_{2s} - h_1}{h_2 - h_1} = \frac{(282.41 - 243.60) \text{ kJ/kg}}{(293.36 - 243.60) \text{ kJ/kg}} = \mathbf{0.780}$$

(b) The exergy destroyed in the compressor is

$$x_{\text{dest}} = w_a - w_{\text{rev}} = 49.76 - 39.81 = \mathbf{9.95 \text{ kJ/kg}}$$

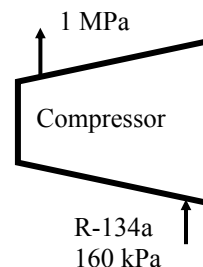

**8-145** The isentropic efficiency of a water pump is specified. The actual power output, the rate of frictional heating, the exergy destruction, and the second-law efficiency are to be determined.

**Assumptions** 1 Steady operating conditions exist. 2 Kinetic and potential energy changes are negligible.

**Analysis** (a) Using saturated liquid properties at the given temperature for the inlet state (Table A-4)

$$T_1 = 30^\circ\text{C} \left\{ \begin{array}{l} h_1 = 125.82 \text{ kJ/kg} \\ s_1 = 0.4367 \text{ kJ/kg}\cdot\text{K} \\ x_1 = 0 \end{array} \right. \left. \vphantom{T_1} \right\} \nu_1 = 0.001004 \text{ m}^3/\text{kg}$$

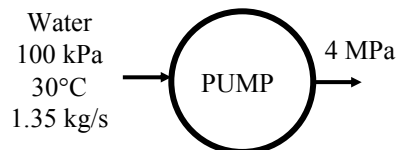

The power input if the process was isentropic is

$$\dot{W}_s = \dot{m} \nu_1 (P_2 - P_1) = (1.35 \text{ kg/s})(0.001004 \text{ m}^3/\text{kg})(4000 - 100) \text{ kPa} = 5.288 \text{ kW}$$

Given the isentropic efficiency, the actual power may be determined to be

$$\dot{W}_a = \frac{\dot{W}_s}{\eta_s} = \frac{5.288 \text{ kW}}{0.70} = \mathbf{7.554 \text{ kW}}$$

(b) The difference between the actual and isentropic works is the frictional heating in the pump

$$\dot{Q}_{\text{frictional}} = \dot{W}_a - \dot{W}_s = 7.554 - 5.288 = \mathbf{2.266 \text{ kW}}$$

(c) The enthalpy at the exit of the pump for the actual process can be determined from

$$\dot{W}_a = \dot{m}(h_2 - h_1) \longrightarrow 7.554 \text{ kW} = (1.35 \text{ kg/s})(h_2 - 125.82) \text{ kJ/kg} \longrightarrow h_2 = 131.42 \text{ kJ/kg}$$

The entropy at the exit is

$$\left. \begin{array}{l} P_2 = 4 \text{ MPa} \\ h_2 = 131.42 \text{ kJ/kg} \end{array} \right\} s_2 = 0.4423 \text{ kJ/kg}\cdot\text{K}$$

The reversible power and the exergy destruction are

$$\begin{aligned} \dot{W}_{\text{rev}} &= \dot{m}[h_2 - h_1 - T_0(s_2 - s_1)] \\ &= (1.35 \text{ kg/s})[(131.42 - 125.82) \text{ kJ/kg} - (20 + 273 \text{ K})(0.4423 - 0.4367) \text{ kJ/kg}\cdot\text{K}] = 5.362 \text{ kW} \end{aligned}$$

$$\dot{X}_{\text{dest}} = \dot{W}_a - \dot{W}_{\text{rev}} = 7.554 - 5.362 = \mathbf{2.193 \text{ kW}}$$

(d) The second-law efficiency is

$$\eta_{\text{II}} = \frac{\dot{W}_{\text{rev}}}{\dot{W}_a} = \frac{5.362 \text{ kW}}{7.554 \text{ kW}} = \mathbf{0.710}$$

**8-146** Argon gas is expanded adiabatically in an expansion valve. The exergy of argon at the inlet, the exergy destruction, and the second-law efficiency are to be determined.

**Assumptions** 1 Steady operating conditions exist. 2 Kinetic and potential energy changes are zero. 3 Argon is an ideal gas with constant specific heats.

**Properties** The properties of argon gas are  $R = 0.2081 \text{ kJ/kg}\cdot\text{K}$ ,  $c_p = 0.5203 \text{ kJ/kg}\cdot^\circ\text{C}$  (Table A-2).

**Analysis** (a) The exergy of the argon at the inlet is

$$\begin{aligned} x_1 &= h_1 - h_0 - T_0(s_1 - s_0) \\ &= c_p(T_1 - T_0) - T_0 \left[ c_p \ln \frac{T_1}{T_0} - R \ln \frac{P_1}{P_0} \right] \\ &= (0.5203 \text{ kJ/kg}\cdot\text{K})(100 - 25)^\circ\text{C} - (298 \text{ K}) \left[ (0.5203 \text{ kJ/kg}\cdot\text{K}) \ln \frac{373 \text{ K}}{298 \text{ K}} - (0.2081 \text{ kJ/kg}\cdot\text{K}) \ln \frac{3500 \text{ kPa}}{100 \text{ kPa}} \right] \\ &= \mathbf{224.7 \text{ kJ/kg}} \end{aligned}$$

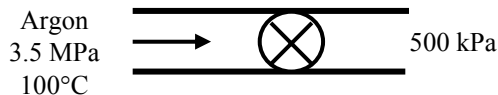

(b) Noting that the temperature remains constant in a throttling process, the exergy destruction is determined from

$$\begin{aligned} x_{\text{dest}} &= T_0 s_{\text{gen}} \\ &= T_0(s_2 - s_1) \\ &= T_0 \left( -R \ln \frac{P_1}{P_0} \right) = (298 \text{ K}) \left[ - (0.2081 \text{ kJ/kg}\cdot\text{K}) \ln \left( \frac{500 \text{ kPa}}{3500 \text{ kPa}} \right) \right] \\ &= \mathbf{120.7 \text{ kJ/kg}} \end{aligned}$$

(c) The second-law efficiency is

$$\eta_{\text{II}} = \frac{x_1 - x_{\text{dest}}}{x_1} = \frac{(224.7 - 120.7) \text{ kJ/kg}}{224.7 \text{ kJ/kg}} = \mathbf{0.463}$$

**8-147** Heat is lost from the air flowing in a diffuser. The exit temperature, the rate of exergy destruction, and the second law efficiency are to be determined.

**Assumptions** 1 Steady operating conditions exist. 2 Potential energy change is negligible. 3 Nitrogen is an ideal gas with variable specific heats.

**Properties** The gas constant of nitrogen is  $R = 0.2968 \text{ kJ/kg}\cdot\text{K}$ .

**Analysis** (a) For this problem, we use the properties from EES software. Remember that for an ideal gas, enthalpy is a function of temperature only whereas entropy is functions of both temperature and pressure. At the inlet of the diffuser and at the dead state, we have

$$\left. \begin{array}{l} T_1 = 15^\circ\text{C} = 423 \text{ K} \\ P_1 = 100 \text{ kPa} \end{array} \right\} \begin{array}{l} h_1 = 130.08 \text{ kJ/kg} \\ s_1 = 7.2006 \text{ kJ/kg}\cdot\text{K} \end{array}$$

$$\left. \begin{array}{l} T_1 = 300 \text{ K} \\ P_1 = 100 \text{ kPa} \end{array} \right\} \begin{array}{l} h_0 = 1.93 \text{ kJ/kg} \\ s_0 = 6.8426 \text{ kJ/kg}\cdot\text{K} \end{array}$$

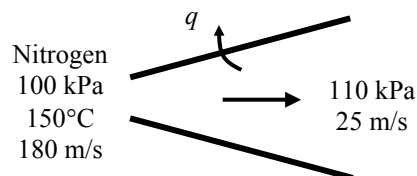

An energy balance on the diffuser gives

$$h_1 + \frac{V_1^2}{2} = h_2 + \frac{V_2^2}{2} + q_{\text{out}}$$

$$130.08 \text{ kJ/kg} + \frac{(180 \text{ m/s})^2}{2} \left( \frac{1 \text{ kJ/kg}}{1000 \text{ m}^2/\text{s}^2} \right) = h_2 + \frac{(25 \text{ m/s})^2}{2} \left( \frac{1 \text{ kJ/kg}}{1000 \text{ m}^2/\text{s}^2} \right) + 4.5 \text{ kJ/kg}$$

$$\longrightarrow h_2 = 141.47 \text{ kJ/kg}$$

The corresponding properties at the exit of the diffuser are

$$\left. \begin{array}{l} h_2 = 141.47 \text{ kJ/kg} \\ P_2 = 110 \text{ kPa} \end{array} \right\} \begin{array}{l} T_2 = \mathbf{160.9^\circ\text{C}} = 433.9 \text{ K} \\ s_2 = 7.1989 \text{ kJ/kg}\cdot\text{K} \end{array}$$

(b) The mass flow rate of the nitrogen is determined to be

$$\dot{m} = \rho_2 A_2 V_2 = \frac{P_2}{RT_2} A_2 V_2 = \frac{110 \text{ kPa}}{(0.2968 \text{ kJ/kg}\cdot\text{K})(433.9 \text{ K})} (0.06 \text{ m}^2)(25 \text{ m/s}) = 1.281 \text{ kg/s}$$

The exergy destruction in the nozzle is the exergy difference between the inlet and exit of the diffuser

$$\dot{X}_{\text{dest}} = \dot{m} \left[ h_1 - h_2 + \frac{V_1^2 - V_2^2}{2} - T_0 (s_1 - s_2) \right]$$

$$= (1.281 \text{ kg/s}) \left[ (130.08 - 141.47) \text{ kJ/kg} + \frac{(180 \text{ m/s})^2 - (25 \text{ m/s})^2}{2} \left( \frac{1 \text{ kJ/kg}}{1000 \text{ m}^2/\text{s}^2} \right) - (300 \text{ K})(7.2006 - 7.1989) \text{ kJ/kg}\cdot\text{K} \right] = \mathbf{5.11 \text{ kW}}$$

(c) The second-law efficiency for this device may be defined as the exergy output divided by the exergy input:

$$\dot{X}_1 = \dot{m} \left[ h_1 - h_0 + \frac{V_1^2}{2} - T_0 (s_1 - s_0) \right]$$

$$= (1.281 \text{ kg/s}) \left[ (130.08 - 1.93) \text{ kJ/kg} + \frac{(180 \text{ m/s})^2}{2} \left( \frac{1 \text{ kJ/kg}}{1000 \text{ m}^2/\text{s}^2} \right) - (300 \text{ K})(7.2006 - 6.8426) \text{ kJ/kg}\cdot\text{K} \right]$$

$$= 47.35 \text{ kW}$$

$$\eta_{\text{II}} = \frac{\dot{X}_2}{\dot{X}_1} = 1 - \frac{\dot{X}_{\text{dest}}}{\dot{X}_1} = 1 - \frac{5.11 \text{ kW}}{47.35 \text{ kW}} = \mathbf{0.892}$$

## Fundamentals of Engineering (FE) Exam Problems

**8-148** Heat is lost through a plane wall steadily at a rate of 800 W. If the inner and outer surface temperatures of the wall are 20°C and 5°C, respectively, and the environment temperature is 0°C, the rate of exergy destruction within the wall is

- (a) 40 W                      (b) 17,500 W                      (c) 765 W                      (d) 32,800 W                      (e) 0 W

*Answer* (a) 40 W

**Solution** Solved by EES Software. Solutions can be verified by copying-and-pasting the following lines on a blank EES screen. (Similar problems and their solutions can be obtained easily by modifying numerical values).

Q=800 "W"

T1=20 "C"

T2=5 "C"

To=0 "C"

"Entropy balance  $S_{in} - S_{out} + S_{gen} = DS_{system}$  for the wall for steady operation gives"

$Q/(T1+273) - Q/(T2+273) + S_{gen} = 0$  "W/K"

$X_{dest} = (To+273) * S_{gen}$  "W"

"Some Wrong Solutions with Common Mistakes:"

$Q/T1 - Q/T2 + S_{gen} = 0$ ;  $W1\_Xdest = (To+273) * S_{gen}$  "Using C instead of K in Sgen"

$S_{gen} = Q / ((T1+T2)/2)$ ;  $W2\_Xdest = (To+273) * S_{gen}$  "Using average temperature in C for Sgen"

$S_{gen} = Q / ((T1+T2)/2 + 273)$ ;  $W3\_Xdest = (To+273) * S_{gen}$  "Using average temperature in K"

$W4\_Xdest = To * S_{gen}$  "Using C for To"

**8-149** Liquid water enters an adiabatic piping system at 15°C at a rate of 5 kg/s. It is observed that the water temperature rises by 0.5°C in the pipe due to friction. If the environment temperature is also 15°C, the rate of exergy destruction in the pipe is

- (a) 8.36 kW      (b) 10.4 kW      (c) 197 kW      (d) 265 kW      (e) 2410 kW

*Answer* (b) 10.4 kW

**Solution** Solved by EES Software. Solutions can be verified by copying-and-pasting the following lines on a blank EES screen. (Similar problems and their solutions can be obtained easily by modifying numerical values).

```
Cp=4.18 "kJ/kg.K"
m=5 "kg/s"
T1=15 "C"
T2=15.5 "C"
To=15 "C"
S_gen=m*Cp*ln((T2+273)/(T1+273)) "kW/K"
X_dest=(To+273)*S_gen "kW"
```

"Some Wrong Solutions with Common Mistakes:"

```
W1_Xdest=(To+273)*m*Cp*ln(T2/T1) "Using deg. C in Sgen"
W2_Xdest=To*m*Cp*ln(T2/T1) "Using deg. C in Sgen and To"
W3_Xdest=(To+273)*Cp*ln(T2/T1) "Not using mass flow rate with deg. C"
W4_Xdest=(To+273)*Cp*ln((T2+273)/(T1+273)) "Not using mass flow rate with K"
```

**8-150** A heat engine receives heat from a source at 1500 K at a rate of 600 kJ/s and rejects the waste heat to a sink at 300 K. If the power output of the engine is 400 kW, the second-law efficiency of this heat engine is

- (a) 42%      (b) 53%      (c) 83%      (d) 67%      (e) 80%

*Answer* (c) 83%

**Solution** Solved by EES Software. Solutions can be verified by copying-and-pasting the following lines on a blank EES screen. (Similar problems and their solutions can be obtained easily by modifying numerical values).

```
Qin=600 "kJ/s"
W=400 "kW"
TL=300 "K"
TH=1500 "K"
Eta_rev=1-TL/TH
Eta_th=W/Qin
Eta_II=Eta_th/Eta_rev
```

"Some Wrong Solutions with Common Mistakes:"

```
W1_Eta_II=Eta_th1/Eta_rev; Eta_th1=1-W/Qin "Using wrong relation for thermal efficiency"
W2_Eta_II=Eta_th "Taking second-law efficiency to be thermal efficiency"
W3_Eta_II=Eta_rev "Taking second-law efficiency to be reversible efficiency"
W4_Eta_II=Eta_th*Eta_rev "Multiplying thermal and reversible efficiencies instead of dividing"
```

**8-151** A water reservoir contains 100 tons of water at an average elevation of 60 m. The maximum amount of electric power that can be generated from this water is

- (a) 8 kWh            (b) 16 kWh            (c) 1630 kWh            (d) 16,300 kWh            (e) 58,800 kWh

*Answer* (b) 16 kWh

**Solution** Solved by EES Software. Solutions can be verified by copying-and-pasting the following lines on a blank EES screen. (Similar problems and their solutions can be obtained easily by modifying numerical values).

```
m=100000 "kg"
h=60 "m"
g=9.81 "m/s^2"
"Maximum power is simply the potential energy change,"
W_max=m*g*h/1000 "kJ"
W_max_kWh=W_max/3600 "kWh"
```

"Some Wrong Solutions with Common Mistakes:"

```
W1_Wmax =m*g*h/3600 "Not using the conversion factor 1000"
W2_Wmax =m*g*h/1000 "Obtaining the result in kJ instead of kWh"
W3_Wmax =m*g*h*3.6/1000 "Using wrong conversion factor"
W4_Wmax =m*h/3600"Not using g and the factor 1000 in calculations"
```

**8-152** A house is maintained at 25°C in winter by electric resistance heaters. If the outdoor temperature is 2°C, the second-law efficiency of the resistance heaters is

- (a) 0%            (b) 7.7%            (c) 8.7%            (d) 13%            (e) 100%

*Answer* (b) 7.7%

**Solution** Solved by EES Software. Solutions can be verified by copying-and-pasting the following lines on a blank EES screen. (Similar problems and their solutions can be obtained easily by modifying numerical values).

```
TL=2+273 "K"
TH=25+273 "K"
To=TL
COP_rev=TH/(TH-TL)
COP=1
Eta_II=COP/COP_rev
```

"Some Wrong Solutions with Common Mistakes:"

```
W1_Eta_II=COP/COP_rev1; COP_rev1=TL/(TH-TL) "Using wrong relation for COP_rev"
W2_Eta_II=1-(TL-273)/(TH-273) "Taking second-law efficiency to be reversible thermal efficiency with C for temp"
W3_Eta_II=COP_rev "Taking second-law efficiency to be reversible COP"
W4_Eta_II=COP_rev2/COP; COP_rev2=(TL-273)/(TH-TL) "Using C in COP_rev relation instead of K, and reversing"
```

**8-153** A 10-kg solid whose specific heat is 2.8 kJ/kg.°C is at a uniform temperature of -10°C. For an environment temperature of 25°C, the exergy content of this solid is

- (a) Less than zero      (b) 0 kJ      (c) 22.3 kJ      (d) 62.5 kJ      (e) 980 kJ

*Answer* (d) 62.5 kJ

**Solution** Solved by EES Software. Solutions can be verified by copying-and-pasting the following lines on a blank EES screen. (Similar problems and their solutions can be obtained easily by modifying numerical values).

```
m=10 "kg"
Cp=2.8 "kJ/kg.K"
T1=-10+273 "K"
To=25+273 "K"
"Exergy content of a fixed mass is x1=u1-u0-To*(s1-s0)+Po*(v1-v0)"
ex=m*(Cp*(T1-To)-To*Cp*ln(T1/To))
```

"Some Wrong Solutions with Common Mistakes:"

```
W1_ex=m*Cp*(To-T1) "Taking the energy content as the exergy content"
W2_ex=m*(Cp*(T1-To)+To*Cp*ln(T1/To)) "Using + for the second term instead of -"
W3_ex=Cp*(T1-To)-To*Cp*ln(T1/To) "Using exergy content per unit mass"
W4_ex=0 "Taking the exergy content to be zero"
```

**8-154** Keeping the limitations imposed by the second-law of thermodynamics in mind, choose the wrong statement below:

- (a) A heat engine cannot have a thermal efficiency of 100%.  
 (b) For all reversible processes, the second-law efficiency is 100%.  
 (c) The second-law efficiency of a heat engine cannot be greater than its thermal efficiency.  
 (d) The second-law efficiency of a process is 100% if no entropy is generated during that process.  
 (e) The coefficient of performance of a refrigerator can be greater than 1.

*Answer* (c) The second-law efficiency of a heat engine cannot be greater than its thermal efficiency.



**8-155** A furnace can supply heat steadily at a 1600 K at a rate of 800 kJ/s. The maximum amount of power that can be produced by using the heat supplied by this furnace in an environment at 300 K is

- (a) 150 kW      (b) 210 kW      (c) 325 kW      (d) 650 kW      (e) 984 kW

*Answer* (d) 650 kW

**Solution** Solved by EES Software. Solutions can be verified by copying-and-pasting the following lines on a blank EES screen. (Similar problems and their solutions can be obtained easily by modifying numerical values).

```
Q_in=800 "kJ/s"
TL=300 "K"
TH=1600 "K"
W_max=Q_in*(1-TL/TH) "kW"
```

"Some Wrong Solutions with Common Mistakes:"

```
W1_Wmax=W_max/2 "Taking half of Wmax"
W2_Wmax=Q_in/(1-TL/TH) "Dividing by efficiency instead of multiplying by it"
W3_Wmax =Q_in*TL/TH "Using wrong relation"
W4_Wmax=Q_in "Assuming entire heat input is converted to work"
```

**8-156** Air is throttled from 50°C and 800 kPa to a pressure of 200 kPa at a rate of 0.5 kg/s in an environment at 25°C. The change in kinetic energy is negligible, and no heat transfer occurs during the process. The power potential wasted during this process is

- (a) 0      (b) 0.20 kW      (c) 47 kW      (d) 59 kW      (e) 119 kW

*Answer* (d) 59 kW

**Solution** Solved by EES Software. Solutions can be verified by copying-and-pasting the following lines on a blank EES screen. (Similar problems and their solutions can be obtained easily by modifying numerical values).

```
R=0.287 "kJ/kg.K"
Cp=1.005 "kJ/kg.K"
m=0.5 "kg/s"
T1=50+273 "K"
P1=800 "kPa"
To=25 "C"
P2=200 "kPa"
"Temperature of an ideal gas remains constant during throttling since h=const and h=h(T)"
T2=T1
ds=Cp*ln(T2/T1)-R*ln(P2/P1)
X_dest=(To+273)*m*ds "kW"
```

"Some Wrong Solutions with Common Mistakes:"

```
W1_dest=0 "Assuming no loss"
W2_dest=(To+273)*ds "Not using mass flow rate"
W3_dest=To*m*ds "Using C for To instead of K"
W4_dest=m*(P1-P2) "Using wrong relations"
```

**8-157** Steam enters a turbine steadily at 4 MPa and 400°C and exits at 0.2 MPa and 150°C in an environment at 25°C. The decrease in the exergy of the steam as it flows through the turbine is

- (a) 58 kJ/kg      (b) 445 kJ/kg      (c) 458 kJ/kg      (d) 518 kJ/kg      (e) 597 kJ/kg

*Answer* (e) 597 kJ/kg

**Solution** Solved by EES Software. Solutions can be verified by copying-and-pasting the following lines on a blank EES screen. (Similar problems and their solutions can be obtained easily by modifying numerical values).

```
P1=4000 "kPa"
T1=400 "C"
P2=200 "kPa"
T2=150 "C"
To=25 "C"
h1=ENTHALPY(Steam_IAPWS,T=T1,P=P1)
s1=ENTROPY(Steam_IAPWS,T=T1,P=P1)
h2=ENTHALPY(Steam_IAPWS,T=T2,P=P2)
s2=ENTROPY(Steam_IAPWS,T=T2,P=P2)
"Exergy change of s fluid stream is Dx=h2-h1-To(s2-s1)"
-Dx=h2-h1-(To+273)*(s2-s1)
```

"Some Wrong Solutions with Common Mistakes:"

```
-W1_Dx=0 "Assuming no exergy destruction"
-W2_Dx=h2-h1 "Using enthalpy change"
-W3_Dx=h2-h1-To*(s2-s1) "Using C for To instead of K"
-W4_Dx=(h2+(T2+273)*s2)-(h1+(T1+273)*s1) "Using wrong relations for exergy"
```

## 8- 158 ... 8- 162 Design and Essay Problems

