

Chapter Three

Section 3.1

1. Let $y = e^{rt}$, so that $y' = r e^{rt}$ and $y'' = r^2 e^{rt}$. Direct substitution into the differential equation yields $(r^2 + 2r - 3)e^{rt} = 0$. Canceling the exponential, the characteristic equation is $r^2 + 2r - 3 = 0$. The roots of the equation are $r = -3, 1$. Hence the general solution is $y = c_1 e^t + c_2 e^{-3t}$.
2. Let $y = e^{rt}$. Substitution of the assumed solution results in the characteristic equation $r^2 + 3r + 2 = 0$. The roots of the equation are $r = -2, -1$. Hence the general solution is $y = c_1 e^{-t} + c_2 e^{-2t}$.
4. Substitution of the assumed solution $y = e^{rt}$ results in the characteristic equation $2r^2 - 3r + 1 = 0$. The roots of the equation are $r = 1/2, 1$. Hence the general solution is $y = c_1 e^{t/2} + c_2 e^t$.
6. The characteristic equation is $4r^2 - 9 = 0$, with roots $r = \pm 3/2$. Therefore the general solution is $y = c_1 e^{-3t/2} + c_2 e^{3t/2}$.
8. The characteristic equation is $r^2 - 2r - 2 = 0$, with roots $r = 1 \pm \sqrt{3}$. Hence the general solution is $y = c_1 \exp(1 - \sqrt{3})t + c_2 \exp(1 + \sqrt{3})t$.
9. Substitution of the assumed solution $y = e^{rt}$ results in the characteristic equation $r^2 + r - 2 = 0$. The roots of the equation are $r = -2, 1$. Hence the general solution is $y = c_1 e^{-2t} + c_2 e^t$. Its derivative is $y' = -2c_1 e^{-2t} + c_2 e^t$. Based on the first condition, $y(0) = 1$, we require that $c_1 + c_2 = 1$. In order to satisfy $y'(0) = 1$, we find that $-2c_1 + c_2 = 1$. Solving for the constants, $c_1 = 0$ and $c_2 = 1$. Hence the specific solution is $y(t) = e^t$.
11. Substitution of the assumed solution $y = e^{rt}$ results in the characteristic equation $6r^2 - 5r + 1 = 0$. The roots of the equation are $r = 1/3, 1/2$. Hence the general solution is $y = c_1 e^{t/3} + c_2 e^{t/2}$. Its derivative is $y' = c_1 e^{t/3}/3 + c_2 e^{t/2}/2$. Based on the first condition, $y(0) = 1$, we require that $c_1 + c_2 = 4$. In order to satisfy the condition $y'(0) = 1$, we find that $c_1/3 + c_2/2 = 0$. Solving for the constants, $c_1 = 12$ and $c_2 = -8$. Hence the specific solution is $y(t) = 12 e^{t/3} - 8 e^{t/2}$.
12. The characteristic equation is $r^2 + 3r = 0$, with roots $r = -3, 0$. Therefore the general solution is $y = c_1 + c_2 e^{-3t}$, with derivative $y' = -3c_2 e^{-3t}$. In order to satisfy the initial conditions, we find that $c_1 + c_2 = -2$, and $-3c_2 = 3$. Hence the specific solution is $y(t) = -1 - e^{-3t}$.
13. The characteristic equation is $r^2 + 5r + 3 = 0$, with roots

$$r_{1,2} = -\frac{5}{2} \pm \frac{\sqrt{13}}{2}.$$

The general solution is $y = c_1 \exp\left(-5 - \sqrt{13}\right)t/2 + c_2 \exp\left(-5 + \sqrt{13}\right)t/2$, with derivative

$$y' = \frac{-5 - \sqrt{13}}{2} c_1 \exp\left(-5 - \sqrt{13}\right)t/2 + \frac{-5 + \sqrt{13}}{2} c_2 \exp\left(-5 + \sqrt{13}\right)t/2.$$

In order to satisfy the initial conditions, we require that $c_1 + c_2 = 1$, and $\frac{-5 - \sqrt{13}}{2} c_1 + \frac{-5 + \sqrt{13}}{2} c_2 = 0$. Solving for the coefficients, $c_1 = \left(1 - 5/\sqrt{13}\right)/2$ and $c_2 = \left(1 + 5/\sqrt{13}\right)/2$.

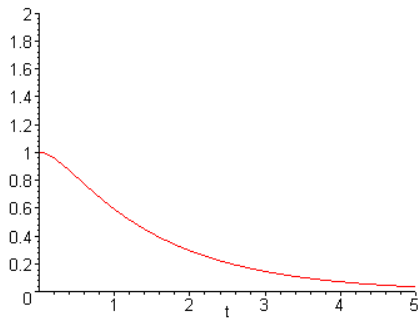

14. The characteristic equation is $2r^2 + r - 4 = 0$, with roots

$$r_{1,2} = -\frac{1}{4} \pm \frac{\sqrt{33}}{4}.$$

The general solution is $y = c_1 \exp\left(-1 - \sqrt{33}\right)t/4 + c_2 \exp\left(-1 + \sqrt{33}\right)t/4$, with derivative

$$y' = \frac{-1 - \sqrt{33}}{4} c_1 \exp\left(-1 - \sqrt{33}\right)t/4 + \frac{-1 + \sqrt{33}}{4} c_2 \exp\left(-1 + \sqrt{33}\right)t/4.$$

In order to satisfy the initial conditions, we require that $c_1 + c_2 = 0$, and $\frac{-1 - \sqrt{33}}{4} c_1 + \frac{-1 + \sqrt{33}}{4} c_2 = 1$. Solving for the coefficients, $c_1 = -2/\sqrt{33}$ and $c_2 = 2/\sqrt{33}$. The specific solution is

$$y(t) = -2 \left[\exp\left(-1 - \sqrt{33}\right)t/4 - \exp\left(-1 + \sqrt{33}\right)t/4 \right] / \sqrt{33}.$$

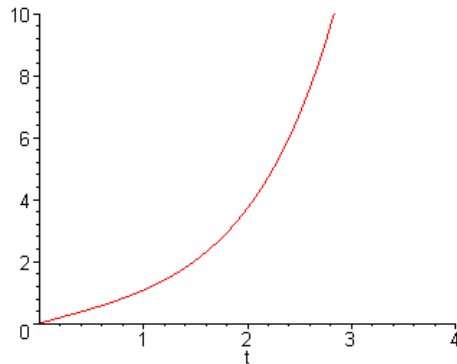

16. The characteristic equation is $4r^2 - 1 = 0$, with roots $r = \pm 1/2$. Therefore the general solution is $y = c_1 e^{-t/2} + c_2 e^{t/2}$. Since the initial conditions are specified at $t = -2$, is more convenient to write $y = d_1 e^{-(t+2)/2} + d_2 e^{(t+2)/2}$. The derivative is given by $y' = -[d_1 e^{-(t+2)/2}]/2 + [d_2 e^{(t+2)/2}]/2$. In order to satisfy the initial conditions, we find that $d_1 + d_2 = 1$, and $-d_1/2 + d_2/2 = -1$. Solving for the coefficients, $d_1 = 3/2$, and $d_2 = -1/2$. The specific solution is

$$\begin{aligned} y(t) &= \frac{3}{2} e^{-(t+2)/2} - \frac{1}{2} e^{(t+2)/2} \\ &= \frac{3}{2e} e^{-t/2} - \frac{e}{2} e^{t/2}. \end{aligned}$$

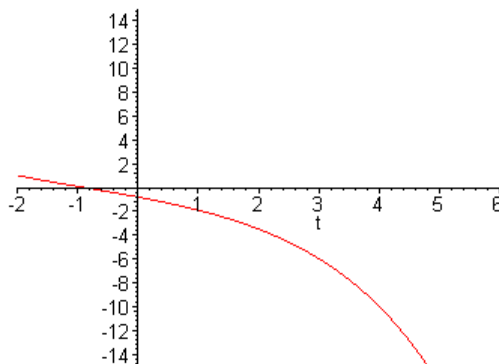

18. An algebraic equation with roots -2 and $-1/2$ is $2r^2 + 5r + 2 = 0$. This is the characteristic equation for the ODE $2y'' + 5y' + 2y = 0$.

20. The characteristic equation is $2r^2 - 3r + 1 = 0$, with roots $r = 1/2, 1$. Therefore the general solution is $y = c_1 e^{t/2} + c_2 e^t$, with derivative $y' = c_1 e^{t/2}/2 + c_2 e^t$. In order to satisfy the initial conditions, we require $c_1 + c_2 = 2$ and $c_1/2 + c_2 = 1/2$. Solving for the coefficients, $c_1 = 3$, and $c_2 = -1$. The specific solution is $y(t) = 3e^{t/2} - e^t$. To find the *stationary point*, set $y' = 3e^{t/2}/2 - e^t = 0$. There is a unique solution, with $t_1 = \ln(9/4)$. The maximum value is then $y(t_1) = 9/4$. To find

the x -intercept, solve the equation $3e^{t/2} - e^t = 0$. The solution is readily found to be $t_2 = \ln 9 \approx 2.1972$.

22. The characteristic equation is $4r^2 - 1 = 0$, with roots $r = \pm 1/2$. Hence the general solution is $y = c_1 e^{-t/2} + c_2 e^{t/2}$, with derivative $y' = -c_1 e^{-t/2}/2 + c_2 e^{t/2}/2$. Invoking the initial conditions, we require that $c_1 + c_2 = 2$ and $-c_1 + c_2 = \beta$. The specific solution is $y(t) = (1 - \beta)e^{-t/2} + (1 + \beta)e^{t/2}$. Based on the form of the solution, it is evident that as $t \rightarrow \infty$, $y(t) \rightarrow 0$ as long as $\beta = -1$.

23. The characteristic equation is $r^2 - (2\alpha - 1)r + \alpha(\alpha - 1) = 0$. Examining the coefficients, the roots are $r = \alpha, \alpha - 1$. Hence the general solution of the differential equation is $y(t) = c_1 e^{\alpha t} + c_2 e^{(\alpha-1)t}$. Assuming $\alpha \in \mathbb{R}$, all solutions will tend to zero as long as $\alpha < 0$. On the other hand, all solutions will become unbounded as long as $\alpha - 1 > 0$, that is, $\alpha > 1$.

25. $y(t) = 2e^{t/2}/5 + 3e^{-2t}/5$.

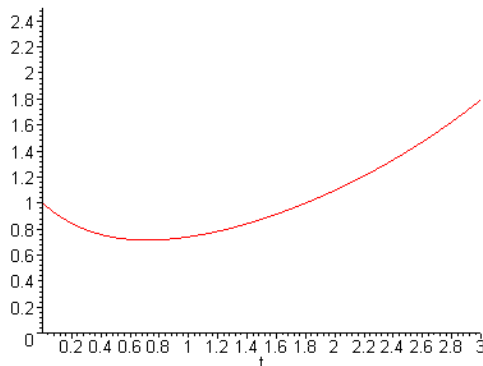

The minimum occurs at $(t_0, y_0) = (0.7167, 0.7155)$.

26(a). The characteristic roots are $r = -3, -2$. The solution of the initial value problem is $y(t) = (6 + \beta)e^{-2t} - (4 + \beta)e^{-3t}$.

(b). The maximum point has coordinates $t_0 = \ln \left[\frac{3(4+\beta)}{2(6+\beta)} \right]$, $y_0 = \frac{4(6+\beta)^3}{27(4+\beta)^2}$.

(c). $y_0 = \frac{4(6+\beta)^3}{27(4+\beta)^2} \geq 4$, as long as $\beta \geq 6 + 6\sqrt{3}$.

(d). $\lim_{\beta \rightarrow \infty} t_0 = \ln \frac{3}{2}$. $\lim_{\beta \rightarrow \infty} y_0 = \infty$.

29. Set $v = y'$ and $v' = y''$. Substitution into the ODE results in the first order equation $t v' + v = 1$. The equation is *linear*, and can be written as $(t v)' = 1$. Hence the general solution is $v = 1 + c_1/t$. Hence $y' = 1 + c_1/t$, and $y = t + c_1 \ln t + c_2$.

31. Setting $v = y'$ and $v' = y''$, the transformed equation is $2t^2 v' + v^3 = 2t v$. This

is a *Bernoulli* equation, with $n = 3$. Let $w = v^{-2}$. Substitution of the new dependent variable yields $-t^2 w' + 1 = 2t w$, or $t^2 w' + 2t w = 1$. Integrating, we find that $w = (t + c_1)/t^2$. Hence $v = \pm t/\sqrt{t + c_1}$, that is, $y' = \pm t/\sqrt{t + c_1}$. Integrating one more time results in $y(t) = \pm \frac{2}{3}(t - 2c_1)\sqrt{t + c_1} + c_2$. (Note that $v = 0$ is also a solution of the transformed equation).

32. Setting $v = y'$ and $v' = y''$, the transformed equation is $v' + v = e^{-t}$. This ODE is *linear*, with integrating factor $\mu(t) = e^t$. Hence $v = y' = (t + c_1)e^{-t}$. Integrating, we obtain $y(t) = -(t + c_1)e^{-t} + c_2$.

33. Set $v = y'$ and $v' = y''$. The resulting equation is $t^2 v' = v^2$. This equation is *separable*, with solution $v = y' = t/(1 + c_1 t)$. Integrating, the general solution is

$$y(t) = t/c_1 - c_1^{-2} \ln|1 + c_1 t| + c_2,$$

as long as $c_1 \neq 0$. For $c_1 = 0$, the solution is $y(t) = t^2/2 + c_2$. Note that $v = 0$ is also a solution of the transformed equation.

35. Let $y' = v$ and $y'' = v dv/dy$. Then $v dv/dy + y = 0$ is the transformed equation for $v = v(y)$. This equation is *separable*, with $v dv = -y dy$. The solution is given by $v^2 = -y^2 + c_1$. Substituting for v , we find that $y' = \pm \sqrt{c_1 - y^2}$. This equation is *also* separable, with solution $\arcsin(y/\sqrt{c_1}) = \pm t + c_2$, or $y(t) = d_1 \sin(t + d_2)$.

36. Let $y' = v$ and $y'' = v dv/dy$. It follows that $v dv/dy + yv^3 = 0$ is the differential equation for $v = v(y)$. This equation is *separable*, with $v^{-2} dv = -y dy$. The solution is given by $v = [y^2/2 + c_1]^{-1}$. Substituting for v , we find that $y' = [y^2/2 + c_1]^{-1}$. This equation is *also* separable, with $(y^2/2 + c_1) dy = dt$. The solution is defined *implicitly* by $y^3/6 + c_1 y + c_2 = t$.

38. Setting $y' = v$ and $y'' = v dv/dy$, the transformed equation is $y v dv/dy - v^3 = 0$. This equation is *separable*, with $v^{-2} dv = dy/y$. The solution is $v(y) = [c_1 - \ln|y|]^{-1}$. Substituting for v , we obtain a *separable* equation, $(c_1 - \ln|y|) dy = dx$. The solution is given *implicitly* by $c_2 y - y \ln|y| + c_3 = t$.

39. Let $y' = v$ and $y'' = v dv/dy$. It follows that $v dv/dy + v^2 = 2e^{-y}$ is the equation for $v = v(y)$. Inspection of the left hand side suggests a substitution $w = v^2$. The resulting equation is $dw/dy + 2w = 4e^{-y}$. This equation is *linear*, with integrating factor $\mu = e^{2y}$.

We obtain $d(e^{2y} w)/dy = 4e^y$, which upon integration yields $w(y) = 4e^{-y} + c_1 e^{-2y}$. Converting back to the original dependent variable, $y' = \pm e^{-y} \sqrt{4e^y + c_1}$. Separating variables, $e^y (4e^y + c_1)^{-1/2} dy = \pm dt$. Integration yields $\sqrt{4e^y + c_1} = \pm 2t + c_2$.

41. Setting $y' = v$ and $y'' = v dv/dy$, the transformed equation is $v dv/dy - 3y^2 = 0$.

This equation is *separable*, with $vdv = 3y^2dy$. The solution is $y' = v = \sqrt{2y^3 + c_1}$. The *positive* root is chosen based on the initial conditions. Furthermore, when $t = 0$, $y = 2$, and $y' = v = 4$. The initial conditions require that $c_1 = 0$. It follows that $y' = \sqrt{2y^3}$. Separating variables and integrating, $1/\sqrt{y} = -t/\sqrt{2} + c_2$. Hence the solution is $y(t) = 2/(1-t)^2$.

42. Setting $v = y'$ and $v' = y''$, the transformed equation is $(1+t^2)v' + 2tv = -3t^{-2}$. Rewrite the equation as $v' + 2tv/(1+t^2) = -3t^{-2}/(1+t^2)$. This equation is *linear*, with integrating factor $\mu = 1+t^2$. Hence we have

$$[(1+t^2)v]' = -3t^{-2}.$$

Integrating both sides, $v = 3t^{-1}/(1+t^2) + c_1/(1+t^2)$. Invoking the initial condition $v(1) = -1$, we require that $c_1 = -5$. Hence $y' = (3-5t)/(t+t^3)$. Integrating, we obtain $y(t) = \frac{3}{2}\ln[t^2/(1+t^2)] - 5\arctan(t) + c_2$. Based on the initial condition $y(1) = 2$, we find that $c_2 = \frac{3}{2}\ln 2 + \frac{5}{4}\pi + 2$.

Section 3.2

1.

$$W(e^{2t}, e^{-3t/2}) = \begin{vmatrix} e^{2t} & e^{-3t/2} \\ 2e^{2t} & -\frac{3}{2}e^{-3t/2} \end{vmatrix} = -\frac{7}{2}e^{t/2}.$$

3.

$$W(e^{-2t}, te^{-2t}) = \begin{vmatrix} e^{-2t} & te^{-2t} \\ -2e^{-2t} & (1-2t)e^{-2t} \end{vmatrix} = e^{-4t}.$$

5.

$$W(e^t \sin t, e^t \cos t) = \begin{vmatrix} e^t \sin t & e^t \cos t \\ e^t(\sin t + \cos t) & e^t(\cos t - \sin t) \end{vmatrix} = -e^{2t}.$$

6.

$$W(\cos^2 \theta, 1 + \cos 2\theta) = \begin{vmatrix} \cos^2 \theta & 1 + \cos 2\theta \\ -2 \sin \theta \cos \theta & -2 \sin 2\theta \end{vmatrix} = 0.$$

7. Write the equation as $y'' + (3/t)y' = 1$. $p(t) = 3/t$ is continuous for all $t > 0$. Since $t_0 > 0$, the IVP has a unique solution for all $t > 0$.

9. Write the equation as $y'' + \frac{3}{t-4}y' + \frac{4}{t(t-4)}y = \frac{2}{t(t-4)}$. The coefficients are not continuous at $t = 0$ and $t = 4$. Since $t_0 \in (0, 4)$, the largest interval is $0 < t < 4$.

10. The coefficient $3 \ln|t|$ is discontinuous at $t = 0$. Since $t_0 > 0$, the largest interval of existence is $0 < t < \infty$.

11. Write the equation as $y'' + \frac{x}{x-3}y' + \frac{\ln|x|}{x-3}y = 0$. The coefficients are discontinuous at $x = 0$ and $x = 3$. Since $x_0 \in (0, 3)$, the largest interval is $0 < x < 3$.

13. $y_1'' = 2$. We see that $t^2(2) - 2(t^2) = 0$. $y_2'' = 2t^{-3}$, with $t^2(y_2'') - 2(y_2) = 0$. Let $y_3 = c_1 t^2 + c_2 t^{-1}$, then $y_3'' = 2c_1 + 2c_2 t^{-3}$. It is evident that y_3 is also a solution.

16. No. Substituting $y = \sin(t^2)$ into the differential equation,

$$-4t^2 \sin(t^2) + 2 \cos(t^2) + 2t \cos(t^2)p(t) + \sin(t^2)q(t) = 0.$$

For the equation to be valid, we must have $p(t) = -1/t$, which is *not* continuous, or even defined, at $t = 0$.

17. $W(e^{2t}, g(t)) = e^{2t}g'(t) - 2e^{2t}g(t) = 3e^{4t}$. Dividing both sides by e^{2t} , we find that g must satisfy the ODE $g' - 2g = 3e^{2t}$. Hence $g(t) = 3te^{2t} + ce^{2t}$.

19. $W(f, g) = fg' - f'g$. Also, $W(u, v) = W(2f - g, f + 2g)$. Upon evaluation, $W(u, v) = 5fg' - 5f'g = 5W(f, g)$.

20. $W(f, g) = fg' - f'g = t \cos t - \sin t$, and $W(u, v) = -4fg' + 4f'g$. Hence $W(u, v) = -4t \cos t + 4 \sin t$.

22. The general solution is $y = c_1e^{-3t} + c_2e^{-t}$. $W(e^{-3t}, e^{-t}) = 2e^{-4t}$, and hence the exponentials form a *fundamental set* of solutions. On the other hand, the *fundamental solutions* must also satisfy the conditions $y_1(1) = 1, y_1'(1) = 0; y_2(1) = 0, y_2'(1) = 1$. For y_1 , the initial conditions require $c_1 + c_2 = e, -3c_1 - c_2 = 0$. The coefficients are $c_1 = -e^3/2, c_2 = 3e/2$. For the solution, y_2 , the initial conditions require $c_1 + c_2 = 0, -3c_1 - c_2 = e$. The coefficients are $c_1 = -e^3/2, c_2 = e/2$. Hence the fundamental solutions are $\{y_1 = -\frac{1}{2}e^{-3(t-1)} + \frac{3}{2}e^{-(t-1)}, y_2 = -\frac{1}{2}e^{-3(t-1)} + \frac{1}{2}e^{-(t-1)}\}$.

23. Yes. $y_1'' = -4 \cos 2t; y_2'' = -4 \sin 2t$. $W(\cos 2t, \sin 2t) = 2$.

24. Clearly, $y_1 = e^t$ is a solution. $y_2' = (1+t)e^t, y_2'' = (2+t)e^t$. Substitution into the ODE results in $(2+t)e^t - 2(1+t)e^t + te^t = 0$. Furthermore, $W(e^t, te^t) = e^{2t}$. Hence the solutions form a fundamental set of solutions.

26. Clearly, $y_1 = x$ is a solution. $y_2' = \cos x, y_2'' = -\sin x$. Substitution into the ODE results in $(1 - x \cot x)(-\sin x) - x(\cos x) + \sin x = 0$. $W(y_1, y_2) = x \cos x - \sin x$,

which is *nonzero* for $0 < x < \pi$. Hence $\{x, \sin x\}$ is a fundamental set of solutions.

28. $P = 1, Q = x, R = 1$. We have $P'' - Q' + R = 0$. The equation is *exact*. Note that $(y')' + (xy)' = 0$. Hence $y' + xy = c_1$. This equation is *linear*, with integrating factor $\mu = e^{x^2/2}$. Therefore the general solution is

$$y(x) = c_1 \exp(-x^2/2) \int_{x_0}^x \exp(u^2/2) du + c_2 \exp(-x^2/2).$$

29. $P = 1, Q = 3x^2, R = x$. Note that $P'' - Q' + R = -5x$, and therefore the differential equation is *not exact*.

31. $P = x^2, Q = x, R = -1$. We have $P'' - Q' + R = 0$. The equation is *exact*. Write the equation as $(x^2y')' - (xy)' = 0$. Integrating, we find that $x^2y' - xy = c$. Divide both sides of the ODE by x^2 . The resulting equation is *linear*, with integrating factor $\mu = 1/x$. Hence $(y/x)' = cx^{-3}$. The solution is $y(t) = c_1x^{-1} + c_2x$.

33. $P = x^2$, $Q = x$, $R = x^2 - \nu^2$. Hence the coefficients are $2P' - Q = 3x$ and $P'' - Q' + R = x^2 + 1 - \nu^2$. The *adjoint* of the original differential equation is given by $x^2\mu'' + 3x\mu' + (x^2 + 1 - \nu^2)\mu = 0$.

35. $P = 1$, $Q = 0$, $R = -x$. Hence the coefficients are given by $2P' - Q = 0$ and $P'' - Q' + R = -x$. Therefore the *adjoint* of the original equation is $\mu'' - x\mu = 0$.

Section 3.3

1. Suppose that $\alpha f(t) + \beta g(t) = 0$, that is, $\alpha(t^2 + 5t) + \beta(t^2 - 5t) = 0$ on some interval I . Then $(\alpha + \beta)t^2 + 5(\alpha - \beta)t = 0, \forall t \in I$. Since a quadratic has at most two roots, we must have $\alpha + \beta = 0$ and $\alpha - \beta = 0$. The only solution is $\alpha = \beta = 0$. Hence the two functions are linearly *independent*.

3. Suppose that $e^{\lambda t} \cos \mu t = A e^{\lambda t} \sin \mu t$, for some $A \neq 0$, on an interval I . Since the function $\sin \mu t \neq 0$ on some subinterval $I_0 \subset I$, we conclude that $\tan \mu t = A$ on I_0 . This is clearly a contradiction, hence the functions are linearly *independent*.

4. Obviously, $f(x) = e g(x)$ for all real numbers x . Hence the functions are linearly *dependent*.

5. Here $f(x) = 3g(x)$ for all real numbers. Hence the functions are linearly *dependent*.

8. Note that $f(x) = g(x)$ for $x \in [0, \infty)$, and $f(x) = -g(x)$ for $x \in (-\infty, 0]$. It follows that the functions are linearly *dependent* on \mathbb{R}^+ and \mathbb{R}^- . Nevertheless, they are linearly *independent* on any open interval containing zero.

9. Since $W(t) = t \sin^2 t$ has only *isolated* zeros, $W(t)$ cannot identically vanish on any open interval. Hence the functions are linearly *independent*.

10. Same argument as in Prob. 9.

11. By linearity of the differential operator, $c_1 y_1$ and $c_2 y_2$ are also solutions.

Calculating

the Wronskian, $W(c_1 y_1, c_2 y_2) = (c_1 y_1)(c_2 y_2)' - (c_1 y_1)'(c_2 y_2) = c_1 c_2 W(y_1, y_2)$.

Since $W(y_1, y_2)$ is not *identically zero*, neither is $W(c_1 y_1, c_2 y_2)$.

13. Direct calculation results in

$$\begin{aligned} W(a_1 y_1 + a_2 y_2, b_1 y_1 + b_2 y_2) &= a_1 b_2 W(y_1, y_2) - b_1 a_2 W(y_1, y_2) \\ &= (a_1 b_2 - a_2 b_1) W(y_1, y_2). \end{aligned}$$

Hence the combinations are also linearly independent as long as $a_1 b_2 - a_2 b_1 \neq 0$.

14. Let $\alpha(\mathbf{i} + \mathbf{j}) + \beta(\mathbf{i} - \mathbf{j}) = 0\mathbf{i} + 0\mathbf{j}$. Then $\alpha + \beta = 0$ and $\alpha - \beta = 0$. The only solution is $\alpha = \beta = 0$. Hence the given vectors are linearly independent. Furthermore, any vector $a_1 \mathbf{i} + a_2 \mathbf{j} = \left(\frac{a_1}{2} + \frac{a_2}{2}\right)(\mathbf{i} + \mathbf{j}) + \left(\frac{a_1}{2} - \frac{a_2}{2}\right)(\mathbf{i} - \mathbf{j})$.

16. Writing the equation in standard form, we find that $P(t) = \sin t / \cos t$. Hence the Wronskian is $W(t) = b \exp\left(-\int \frac{\sin t}{\cos t} dt\right) = b \exp(\ln|\cos t|) = b \cos t$, in which b is some constant.

17. After writing the equation in standard form, we have $P(x) = 1/x$. The Wronskian is $W(t) = c \exp\left(-\int \frac{1}{x} dx\right) = c \exp(-\ln|x|) = c/|x|$, in which c is some constant.

18. Writing the equation in standard form, we find that $P(x) = -2x/(1-x^2)$. The Wronskian is $W(t) = c \exp\left(-\int \frac{-2x}{1-x^2} dx\right) = c \exp(-\ln|1-x^2|) = c|1-x^2|^{-1}$, in which c is some constant.

19. Rewrite the equation as $p(t)y'' + p'(t)y' + q(t)y = 0$. After writing the equation in standard form, we have $P(t) = p'(t)/p(t)$. Hence the Wronskian is

$$W(t) = c \exp\left(-\int \frac{p'(t)}{p(t)} dt\right) = c \exp(-\ln p(t)) = c/p(t).$$

21. The Wronskian associated with the solutions of the differential equation is given by $W(t) = c \exp\left(-\int \frac{-2}{t^2} dt\right) = c \exp(-2/t)$. Since $W(2) = 3$, it follows that for the hypothesized set of solutions, $c = 3e$. Hence $W(4) = 3\sqrt{e}$.

22. For the given differential equation, the Wronskian satisfies the first order differential equation $W' + p(t)W = 0$. Given that W is *constant*, it is necessary that $p(t) \equiv 0$.

23. Direct calculation shows that

$$\begin{aligned} W(fg, fh) &= (fg)(fh)' - (fg)'(fh) \\ &= (fg)(f'h + fh') - (f'g + fg')(fh) \\ &= f^2 W(g, h). \end{aligned}$$

25. Since y_1 and y_2 are solutions, they are differentiable. The hypothesis can thus be restated as $y_1'(t_0) = y_2'(t_0) = 0$ at some point t_0 in the interval of definition. This implies that $W(y_1, y_2)(t_0) = 0$. But $W(y_1, y_2)(t_0) = c \exp\left(-\int p(t) dt\right)$, which *cannot* be equal to zero, unless $c = 0$. Hence $W(y_1, y_2) \equiv 0$, which is ruled out for a fundamental set of solutions.

Section 3.4

2. $\exp(2 - 3i) = e^2 e^{-3i} = e^2 (\cos 3 - i \sin 3)$.

3. $e^{i\pi} = \cos \pi + i \sin \pi = -1$.

4. $\exp(2 - \frac{\pi}{2}i) = e^2 (\cos \frac{\pi}{2} - i \sin \frac{\pi}{2}) = -e^2 i$.

6. $\pi^{-1+2i} = \exp[(-1 + 2i)\ln \pi] = \exp(-\ln \pi) \exp(2 \ln \pi i) = \frac{1}{\pi} \exp(2 \ln \pi i) = \frac{1}{\pi} [\cos(2 \ln \pi) + i \sin(2 \ln \pi)]$.

8. The characteristic equation is $r^2 - 2r + 6 = 0$, with roots $r = 1 \pm i\sqrt{5}$. Hence the general solution is $y = c_1 e^t \cos \sqrt{5}t + c_2 e^t \sin \sqrt{5}t$.

9. The characteristic equation is $r^2 + 2r - 8 = 0$, with roots $r = -4, 2$. The roots are *real* and different, hence the general solution is $y = c_1 e^{-4t} + c_2 e^{2t}$.

10. The characteristic equation is $r^2 + 2r + 2 = 0$, with roots $r = -1 \pm i$. Hence the general solution is $y = c_1 e^{-t} \cos t + c_2 e^{-t} \sin t$.

12. The characteristic equation is $4r^2 + 9 = 0$, with roots $r = \pm \frac{3}{2}i$. Hence the general solution is $y = c_1 \cos \frac{3}{2}t + c_2 \sin \frac{3}{2}t$.

13. The characteristic equation is $r^2 + 2r + 1.25 = 0$, with roots $r = -1 \pm \frac{1}{2}i$. Hence the general solution is $y = c_1 e^{-t} \cos \frac{1}{2}t + c_2 e^{-t} \sin \frac{1}{2}t$.

15. The characteristic equation is $r^2 + r + 1.25 = 0$, with roots $r = -\frac{1}{2} \pm i$. Hence the general solution is $y = c_1 e^{-t/2} \cos t + c_2 e^{-t/2} \sin t$.

16. The characteristic equation is $r^2 + 4r + 6.25 = 0$, with roots $r = -2 \pm \frac{3}{2}i$. Hence the general solution is $y = c_1 e^{-2t} \cos \frac{3}{2}t + c_2 e^{-2t} \sin \frac{3}{2}t$.

17. The characteristic equation is $r^2 + 4 = 0$, with roots $r = \pm 2i$. Hence the general solution is $y = c_1 \cos 2t + c_2 \sin 2t$. Its derivative is $y' = -2c_1 \sin 2t + 2c_2 \cos 2t$. Based on the first condition, $y(0) = 0$, we require that $c_1 = 0$. In order to satisfy the condition $y'(0) = 1$, we find that $2c_2 = 1$. The constants are $c_1 = 0$ and $c_2 = 1/2$. Hence the specific solution is $y(t) = \frac{1}{2} \sin 2t$.

19. The characteristic equation is $r^2 - 2r + 5 = 0$, with roots $r = 1 \pm 2i$. Hence the general solution is $y = c_1 e^t \cos 2t + c_2 e^t \sin 2t$. Based on the condition, $y(\pi/2) = 0$, we require that $c_1 = 0$. It follows that $y = c_2 e^t \sin 2t$, and so the first derivative is $y' = c_2 e^t \sin 2t + 2c_2 e^t \cos 2t$. In order to satisfy the condition $y'(\pi/2) = 2$, we find that $-2e^{\pi/2} c_2 = 2$. Hence we have $c_2 = -e^{-\pi/2}$. Therefore the specific solution is $y(t) = -e^{t-\pi/2} \sin 2t$.

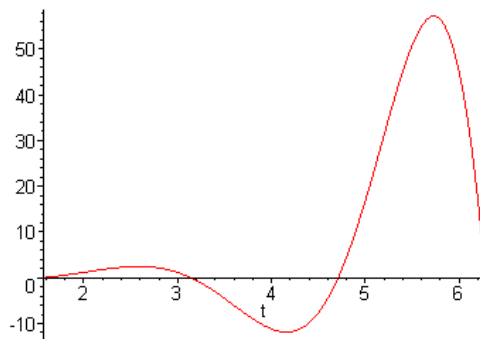

20. The characteristic equation is $r^2 + 1 = 0$, with roots $r = \pm i$. Hence the general solution is $y = c_1 \cos t + c_2 \sin t$. Its derivative is $y' = -c_1 \sin t + c_2 \cos t$. Based on the first condition, $y(\pi/3) = 2$, we require that $c_1 + \sqrt{3}c_2 = 4$. In order to satisfy the condition $y'(\pi/3) = -4$, we find that $-\sqrt{3}c_1 + c_2 = -8$. Solving these for the constants, $c_1 = 1 + 2\sqrt{3}$ and $c_2 = \sqrt{3} - 2$. Hence the specific solution is a steady oscillation, given by $y(t) = (1 + 2\sqrt{3})\cos t + (\sqrt{3} - 2)\sin t$.

21. From Prob. 15, the general solution is $y = c_1 e^{-t/2} \cos t + c_2 e^{-t/2} \sin t$. Invoking the first initial condition, $y(0) = 3$, which implies that $c_1 = 3$. Substituting, it follows that $y = 3e^{-t/2} \cos t + c_2 e^{-t/2} \sin t$, and so the first derivative is

$$y' = -\frac{3}{2}e^{-t/2} \cos t - 3e^{-t/2} \sin t + c_2 e^{-t/2} \cos t - \frac{c_2}{2}e^{-t/2} \sin t.$$

Invoking the initial condition, $y'(0) = 1$, we find that $-\frac{3}{2} + c_2 = 1$, and so $c_2 = \frac{5}{2}$. Hence the specific solution is $y(t) = 3e^{-t/2} \cos t + \frac{5}{2}e^{-t/2} \sin t$.

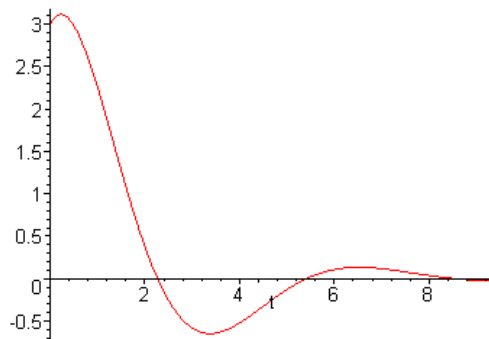

24(a). The characteristic equation is $5r^2 + 2r + 7 = 0$, with roots $r = -\frac{1}{5} \pm i\frac{\sqrt{34}}{5}$. The solution is $u = c_1 e^{-t/5} \cos \frac{\sqrt{34}}{5}t + c_2 e^{-t/5} \sin \frac{\sqrt{34}}{5}t$. Invoking the given initial conditions, we obtain the equations for the coefficients: $c_1 = 2$, $-2 + \sqrt{34}c_2 = 5$. That is, $c_1 = 2$, $c_2 = 7/\sqrt{34}$. Hence the specific solution is

$$u(t) = 2e^{-t/5} \cos \frac{\sqrt{34}}{5}t + \frac{7}{\sqrt{34}}e^{-t/5} \sin \frac{\sqrt{34}}{5}t.$$

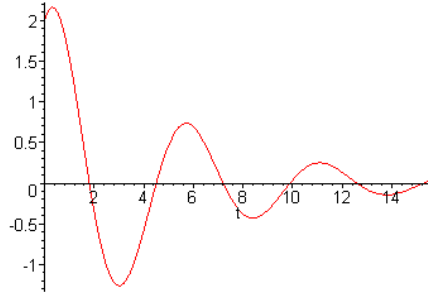

(b). Based on the graph of $u(t)$, T is in the interval $14 < t < 16$. A numerical solution on that interval yields $T \approx 14.5115$.

26(a). The characteristic equation is $r^2 + 2ar + (a^2 + 1) = 0$, with roots $r = -a \pm i$. Hence the general solution is $y(t) = c_1 e^{-at} \cos t + c_2 e^{-at} \sin t$. Based on the initial conditions, we find that $c_1 = 1$ and $c_2 = a$. Therefore the specific solution is given by

$$\begin{aligned} y(t) &= e^{-at} \cos t + a e^{-at} \sin t \\ &= \sqrt{1 + a^2} e^{-at} \cos(t - \phi), \end{aligned}$$

in which $\phi = \tan^{-1}(a)$.

(b). For estimation, note that $|y(t)| \leq \sqrt{1 + a^2} e^{-at}$. Now consider the inequality $\sqrt{1 + a^2} e^{-at} \leq 1/10$. The inequality holds for $t \geq \frac{1}{a} \ln [10\sqrt{1 + a^2}]$. Therefore $T \leq \frac{1}{a} \ln [10\sqrt{1 + a^2}]$. Setting $a = 1$, numerical analysis gives $T \approx 1.8763$.

(c). Similarly, $T_{1/4} \approx 7.4284$, $T_{1/2} \approx 4.3003$, $T_2 \approx 1.5116$, $T_3 \approx 1.1496$.

(d).

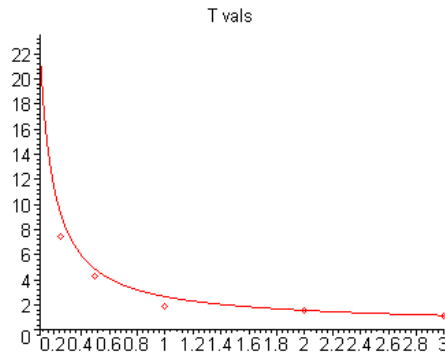

Note that the estimates T_a approach the graph of $\frac{1}{a} \ln \left[10\sqrt{1+a^2} \right]$ as a gets large.

27. Direct calculation gives the result. On the other hand, it was shown in Prob. 3.3.23 that $W(fg, fh) = f^2W(g, h)$. Hence

$$\begin{aligned} W(e^{\lambda t} \cos \mu t, e^{\lambda t} \sin \mu t) &= e^{2\lambda t} W(\cos \mu t, \sin \mu t) \\ &= e^{2\lambda t} [\cos \mu t (\sin \mu t)' - (\cos \mu t)' \sin \mu t] \\ &= \mu e^{2\lambda t}. \end{aligned}$$

28(a). Clearly, y_1 and y_2 are solutions. Also, $W(\cos t, \sin t) = \cos^2 t + \sin^2 t = 1$.

(b). $y' = i e^{it}$, $y'' = i^2 e^{it} = -e^{it}$. Evidently, y is a solution and so $y = c_1 y_1 + c_2 y_2$.

(c). Setting $t = 0$, $1 = c_1 \cos 0 + c_2 \sin 0$, and $c_1 = 1$. Differentiating, $i e^{it} = c_2 \cos t$. Setting $t = 0$, $i = c_2 \cos 0$ and hence $c_2 = i$. Therefore $e^{it} = \cos t + i \sin t$.

29. Euler's formula is $e^{it} = \cos t + i \sin t$. It follows that $e^{-it} = \cos t - i \sin t$. Adding these equations, $e^{it} + e^{-it} = 2 \cos t$. Subtracting the two equations results in $e^{it} - e^{-it} = 2i \sin t$.

30. Let $r_1 = \lambda_1 + i\mu_1$, and $r_2 = \lambda_2 + i\mu_2$. Then

$$\begin{aligned} \exp(r_1 + r_2)t &= \exp[(\lambda_1 + \lambda_2)t + i(\mu_1 + \mu_2)t] \\ &= e^{(\lambda_1 + \lambda_2)t} [\cos(\mu_1 + \mu_2)t + i \sin(\mu_1 + \mu_2)t] \\ &= e^{(\lambda_1 + \lambda_2)t} [(\cos \mu_1 t + i \sin \mu_1 t)(\cos \mu_2 t + i \sin \mu_2 t)] \\ &= e^{\lambda_1 t} (\cos \mu_1 t + i \sin \mu_1 t) \cdot e^{\lambda_2 t} (\cos \mu_2 t + i \sin \mu_2 t) \end{aligned}$$

Hence $e^{(r_1 + r_2)t} = e^{r_1 t} e^{r_2 t}$.

32. If $\phi(t) = u(t) + i v(t)$ is a solution, then

$$(u + iv)'' + p(t)(u + iv)' + q(t)(u + iv) = 0,$$

and $(u'' + iv'') + p(t)(u' + iv') + q(t)(u + iv) = 0$. After expanding the equation and separating the *real* and *imaginary* parts,

$$\begin{aligned} u'' + p(t)u' + q(t)u &= 0 \\ v'' + p(t)v' + q(t)v &= 0 \end{aligned}$$

Hence both $u(t)$ and $v(t)$ are solutions.

34(a). By the *chain rule*, $y(x)' = \frac{dy}{dx} x'$. In general, $\frac{dz}{dt} = \frac{dz}{dx} \frac{dx}{dt}$. Setting $z = \frac{dy}{dt}$, we have $\frac{d^2y}{dt^2} = \frac{dz}{dx} \frac{dx}{dt} = \frac{d}{dx} \left[\frac{dy}{dx} \frac{dx}{dt} \right] \frac{dx}{dt} = \left[\frac{d^2y}{dx^2} \frac{dx}{dt} \right] \frac{dx}{dt} + \frac{dy}{dx} \frac{d}{dx} \left[\frac{dx}{dt} \right] \frac{dx}{dt}$. However, $\frac{d}{dx} \left[\frac{dx}{dt} \right] \frac{dx}{dt} = \left[\frac{d^2x}{dt^2} \right] \frac{dt}{dx} \cdot \frac{dx}{dt} = \frac{d^2x}{dt^2}$. Hence $\frac{d^2y}{dt^2} = \frac{d^2y}{dx^2} \left[\frac{dx}{dt} \right]^2 + \frac{dy}{dx} \frac{d^2x}{dt^2}$.

(b). Substituting the results in Part(a) into the general ODE, $y'' + p(t)y' + q(t)y = 0$, we find that

$$\frac{d^2y}{dx^2} \left[\frac{dx}{dt} \right]^2 + \frac{dy}{dx} \frac{d^2x}{dt^2} + p(t) \frac{dy}{dx} \frac{dx}{dt} + q(t)y = 0.$$

Collecting the terms,

$$\left[\frac{dx}{dt} \right]^2 \frac{d^2y}{dx^2} + \left[\frac{d^2x}{dt^2} + p(t) \frac{dx}{dt} \right] \frac{dy}{dx} + q(t)y = 0.$$

(c). Assuming $\left[\frac{dx}{dt} \right]^2 = k q(t)$, and $q(t) > 0$, we find that $\frac{dx}{dt} = \sqrt{k q(t)}$, which can be integrated. That is, $x = \xi(t) = \int \sqrt{k q(t)} dt$.

(d). Let $k = 1$. It follows that $\frac{d^2x}{dt^2} + p(t) \frac{dx}{dt} = \frac{d\xi}{dt} + p(t)\xi(t) = \frac{q'}{2\sqrt{q}} + p\sqrt{q}$. Hence

$$\left[\frac{d^2x}{dt^2} + p(t) \frac{dx}{dt} \right] / \left[\frac{dx}{dt} \right]^2 = \frac{q'(t) + 2p(t)q(t)}{2[q(t)]^{3/2}}.$$

As long as $dx/dt \neq 0$, the differential equation can be expressed as

$$\frac{d^2y}{dx^2} + \left[\frac{q'(t) + 2p(t)q(t)}{2[q(t)]^{3/2}} \right] \frac{dy}{dx} + y = 0.$$

* For the case $q(t) < 0$, write $q(t) = -[-q(t)]$, and set $\left[\frac{dx}{dt} \right]^2 = -q(t)$.

36. $p(t) = 3t$ and $q(t) = t^2$. We have $x = \int t dt = t^2/2$. Furthermore,

$$\frac{q'(t) + 2p(t)q(t)}{2[q(t)]^{3/2}} = (1 + 3t^2)/t^2.$$

The ratio is *not* constant, and therefore the equation cannot be transformed.

37. $p(t) = t - 1/t$ and $q(t) = t^2$. We have $x = \int t dt = t^2/2$. Furthermore,

$$\frac{q'(t) + 2p(t)q(t)}{2[q(t)]^{3/2}} = 1.$$

The ratio is constant, and therefore the equation can be transformed. From Prob. 35, the transformed equation is

$$\frac{d^2y}{dx^2} + \frac{dy}{dx} + y = 0.$$

Based on the methods in this section, the characteristic equation is $r^2 + r + 1 = 0$, with roots $r = -\frac{1}{2} \pm i\frac{\sqrt{3}}{2}$. The general solution is

$$y(x) = c_1 e^{-x/2} \cos \sqrt{3}x/2 + c_2 e^{-x/2} \sin \sqrt{3}x/2.$$

Since $x = t^2/2$, the solution in the original variable t is

$$y(t) = e^{-t^2/4} \left[c_1 \cos \left(\sqrt{3} t^2/4 \right) + c_2 \sin \left(\sqrt{3} t^2/4 \right) \right].$$

40. $p(t) = 4/t$ and $q(t) = 2/t^2$. We have $x = \sqrt{2} \int t^{-1} dt = \sqrt{2} \ln t$. Furthermore,

$$\frac{q'(t) + 2p(t)q(t)}{2[q(t)]^{3/2}} = \frac{3}{\sqrt{2}}.$$

The ratio is constant, and therefore the equation can be transformed. In fact, we obtain

$$\frac{d^2y}{dx^2} + \frac{3}{\sqrt{2}} \frac{dy}{dx} + y = 0.$$

Based on the methods in this section, the characteristic equation is $\sqrt{2} r^2 + 3r + \sqrt{2} = 0$, with roots $r = -\sqrt{2}, -1/\sqrt{2}$. The general solution is

$$y(x) = c_1 e^{-\sqrt{2}x} + c_2 e^{-x/\sqrt{2}}.$$

Since $x = \sqrt{2} \ln t$, the solution in the original variable t is

$$\begin{aligned} y(t) &= c_1 e^{-2 \ln t} + c_2 e^{-\ln t} \\ &= c_1 t^{-2} + c_2 t^{-1}. \end{aligned}$$

41. $p(t) = 3/t$ and $q(t) = 1.25/t^2$. We have $x = \sqrt{1.25} \int t^{-1} dt = \sqrt{1.25} \ln t$.

Checking the feasibility of the transformation,

$$\frac{q'(t) + 2p(t)q(t)}{2[q(t)]^{3/2}} = \frac{4}{\sqrt{5}}.$$

The ratio is constant, and therefore the equation can be transformed. In fact, we obtain

$$\frac{d^2y}{dx^2} + \frac{4}{\sqrt{5}} \frac{dy}{dx} + y = 0.$$

Based on the methods in this section, the characteristic equation is

$\sqrt{5} r^2 + 4r + \sqrt{5} = 0$, with roots $r = -\frac{2}{\sqrt{5}} \pm i \frac{1}{\sqrt{5}}$. The general solution is

$$y(x) = c_1 e^{-2x/\sqrt{5}} \cos x/\sqrt{5} + c_2 e^{-2x/\sqrt{5}} \sin x/\sqrt{5}.$$

Since $2x/\sqrt{5} = \ln t$, the solution in the original variable t is

$$\begin{aligned}
 y(t) &= c_1 e^{-\ln t} \cos(\ln \sqrt{t}) + c_2 e^{-\ln t} \sin(\ln \sqrt{t}) \\
 &= t^{-1} [c_1 \cos(\ln \sqrt{t}) + c_2 \sin(\ln \sqrt{t})].
 \end{aligned}$$

42. $p(t) = -4/t$ and $q(t) = -6/t^2$. Set $x = \sqrt{6} \int t^{-1} dt = \sqrt{6} \ln t$.

Checking the feasibility of the transformation (*see Prob. 34 d, with $q < 0$),

$$\frac{-q'(t) - 2p(t)q(t)}{2[-q(t)]^{3/2}} = \frac{-5}{\sqrt{6}}.$$

The ratio is constant, and therefore the equation can be transformed. In fact, we obtain

$$\frac{d^2 y}{dx^2} + \frac{-5}{\sqrt{6}} \frac{dy}{dx} - y = 0.$$

Based on the methods in this section, the characteristic equation is $\sqrt{6} r^2 - 5$

$$r - \sqrt{6} = 0,$$

with roots $r = \sqrt{6}$, $-1/\sqrt{6}$. The general solution is

$$y(x) = c_1 e^{\sqrt{6}x} + c_2 e^{-x/\sqrt{6}}.$$

Since $x = \sqrt{6} \ln t$, the solution in the original variable t is

$$\begin{aligned}
 y(t) &= c_1 e^{6 \ln t} + c_2 e^{-\ln t} \\
 &= c_1 t^6 + c_2 t^{-1}.
 \end{aligned}$$

Section 3.5

2. The characteristic equation is $9r^2 + 6r + 1 = 0$, with the *double* root $r = -1/3$. Based on the discussion in this section, the general solution is $y(t) = c_1 e^{-t/3} + c_2 t e^{-t/3}$.
3. The characteristic equation is $4r^2 - 4r - 3 = 0$, with roots $r = -1/2, 3/2$. The general solution is $y(t) = c_1 e^{-t/2} + c_2 e^{3t/2}$.
4. The characteristic equation is $4r^2 + 12r + 9 = 0$, with the *double* root $r = -3/2$. Based on the discussion in this section, the general solution is $y(t) = (c_1 + c_2 t) e^{-3t/2}$.
5. The characteristic equation is $r^2 - 2r + 10 = 0$, with complex roots $r = 1 \pm 3i$. The general solution is $y(t) = c_1 e^t \cos 3t + c_2 e^t \sin 3t$.
6. The characteristic equation is $r^2 - 6r + 9 = 0$, with the *double* root $r = 3$. The general solution is $y(t) = c_1 e^{3t} + c_2 t e^{3t}$.
7. The characteristic equation is $4r^2 + 17r + 4 = 0$, with roots $r = -1/4, -4$. The general solution is $y(t) = c_1 e^{-t/4} + c_2 e^{-4t}$.
8. The characteristic equation is $16r^2 + 24r + 9 = 0$, with the *double* root $r = -3/4$. The general solution is $y(t) = c_1 e^{-3t/4} + c_2 t e^{-3t/4}$.
10. The characteristic equation is $2r^2 + 2r + 1 = 0$, with complex roots $r = -\frac{1}{2} \pm \frac{1}{2}i$. The general solution is $y(t) = c_1 e^{-t/2} \cos t/2 + c_2 e^{-t/2} \sin t/2$.
11. The characteristic equation is $9r^2 - 12r + 4 = 0$, with the *double* root $r = 2/3$. The general solution is $y(t) = c_1 e^{2t/3} + c_2 t e^{2t/3}$. Invoking the first initial condition, it follows that $c_1 = 2$. Now $y'(t) = (4/3 + c_2) e^{2t/3} + 2c_2 t e^{2t/3}/3$. Invoking the second initial condition, $4/3 + c_2 = -1$, or $c_2 = -7/3$. Hence $y(t) = 2e^{2t/3} - \frac{7}{3} t e^{2t/3}$. Since the *second* term dominates for large t , $y(t) \rightarrow -\infty$.
13. The characteristic equation is $9r^2 + 6r + 82 = 0$, with complex roots $r = -\frac{1}{3} \pm 3i$. The general solution is $y(t) = c_1 e^{-t/3} \cos 3t + c_2 e^{-t/3} \sin 3t$. Based on the first initial condition, $c_1 = -1$. Invoking the second initial condition, $1/3 + 3c_2 = 2$, or $c_2 = \frac{5}{9}$. Hence $y(t) = -e^{-t/3} \cos 3t + \frac{5}{9} e^{-t/3} \sin 3t$.

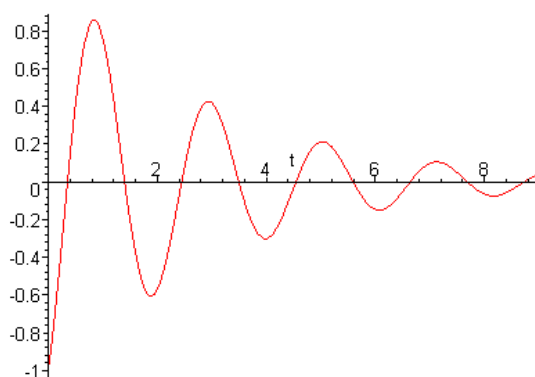

15(a). The characteristic equation is $4r^2 + 12r + 9 = 0$, with the *double* root $r = -\frac{3}{2}$. The general solution is $y(t) = c_1 e^{-3t/2} + c_2 t e^{-3t/2}$. Invoking the first initial condition, it follows that $c_1 = 1$. Now $y'(t) = (-3/2 + c_2)e^{2t/3} - \frac{3}{2}c_2 t e^{2t/3}$. The second initial condition requires that $-3/2 + c_2 = -4$, or $c_2 = -5/2$. Hence the specific solution is $y(t) = e^{-3t/2} - \frac{5}{2}t e^{-3t/2}$.

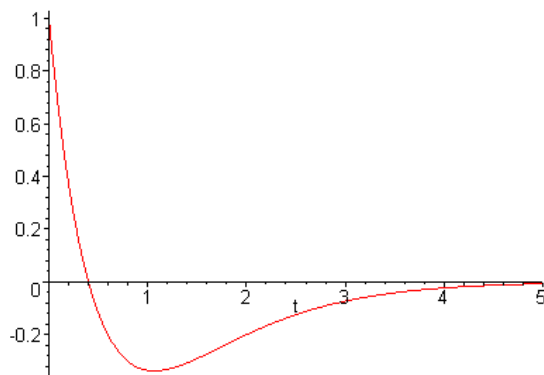

(b). The solution crosses the x -axis at $t = 0.4$.

(c). The solution has a minimum at the point $(16/15, -5e^{-8/5}/3)$.

(d). Given that $y'(0) = b$, we have $-3/2 + c_2 = b$, or $c_2 = b + 3/2$. Hence the solution is $y(t) = e^{-3t/2} + (b + \frac{3}{2})t e^{-3t/2}$. Since the *second* term dominates, the *long-term* solution depends on the *sign* of the coefficient $b + \frac{3}{2}$. The critical value is $b = -\frac{3}{2}$.

16. The characteristic roots are $r_1 = r_2 = 1/2$. Hence the general solution is given by $y(t) = c_1 e^{t/2} + c_2 t e^{t/2}$. Invoking the initial conditions, we require that $c_1 = 2$, and that $1 + c_2 = b$. The specific solution is $y(t) = 2e^{t/2} + (b - 1)t e^{t/2}$. Since the *second* term dominates, the *long-term* solution depends on the *sign* of the coefficient $b - 1$. The critical value is $b = 1$.

18(a). The characteristic roots are $r_1 = r_2 = -2/3$. Therefore the general solution is given by $y(t) = c_1 e^{-2t/3} + c_2 t e^{-2t/3}$. Invoking the initial conditions, we require that $c_1 = a$, and that $-2a/3 + c_2 = -1$. After solving for the coefficients, the specific solution is $y(t) = a e^{-2t/3} + \left(\frac{2a}{3} - 1\right) t e^{-2t/3}$.

(b). Since the *second* term dominates, the *long-term* solution depends on the *sign* of the coefficient $\frac{2a}{3} - 1$. The critical value is $a = 3/2$.

20(a). The characteristic equation is $r^2 + 2ar + a^2 = 0$, with *double* root $r = -a$. Hence one solution is $y_1(t) = c_1 e^{-at}$.

(b). Recall that the Wronskian satisfies the differential equation $W' + 2aW = 0$. The solution of this equation is $W(t) = c e^{-2at}$.

(c). By definition, $W = y_1 y_2' - y_1' y_2$. Hence $c_1 e^{-at} y_2' + a c_1 e^{-at} y_2 = c e^{-2at}$. That is, $y_2' + a y_2 = c_2 e^{-at}$. This equation is first order *linear*, with general solution $y_2(t) = c_2 t e^{-at} + c_3 e^{-at}$. Setting $c_2 = 1$ and $c_3 = 0$, we obtain $y_2(t) = t e^{-at}$.

22(a). Write $ar^2 + br + c = a\left(r^2 + \frac{b}{a}r + \frac{c}{a}\right)$. It follows that $\frac{b}{a} = -2r_1$ and $\frac{c}{a} = r_1^2$. Hence $ar^2 + br + c = ar^2 - 2ar_1r + ar_1^2 = a(r^2 - 2r_1r + r_1^2) = a(r - r_1)^2$. We find that $L[e^{rt}] = (ar^2 + br + c)e^{rt} = a(r - r_1)^2 e^{rt}$. Setting $r = r_1$, $L[e^{r_1 t}] = 0$.

(b). Differentiating Eq.(i) with respect to r ,

$$\frac{\partial}{\partial r} L[e^{rt}] = a t e^{rt} (r - r_1)^2 + 2a e^{rt} (r - r_1).$$

Now observe that

$$\begin{aligned} \frac{\partial}{\partial r} L[e^{rt}] &= \frac{\partial}{\partial r} \left[a \frac{\partial^2}{\partial t^2} (e^{rt}) + b \frac{\partial}{\partial t} (e^{rt}) + c (e^{rt}) \right] \\ &= \left[a \frac{\partial^2}{\partial t^2} \left(\frac{\partial}{\partial r} e^{rt} \right) + b \frac{\partial}{\partial t} \left(\frac{\partial}{\partial r} e^{rt} \right) + c \left(\frac{\partial}{\partial r} e^{rt} \right) \right] \\ &= a \frac{\partial^2}{\partial t^2} (t e^{rt}) + b \frac{\partial}{\partial t} (t e^{rt}) + c (t e^{rt}). \end{aligned}$$

Hence $L[t e^{r_1 t}] = a t e^{r_1 t} (r - r_1)^2 + 2a e^{r_1 t} (r - r_1)$. Setting $r = r_1$, $L[t e^{r_1 t}] = 0$.

23. Set $y_2(t) = t^2 v(t)$. Substitution into the ODE results in

$$t^2 (t^2 v'' + 4t v' + 2v) - 4t (t^2 v' + 2tv) + 6t^2 v = 0.$$

After collecting terms, we end up with $t^4 v'' = 0$. Hence $v(t) = c_1 + c_2 t$, and thus $y_2(t) = c_1 t^2 + c_2 t^3$. Setting $c_1 = 0$ and $c_2 = 1$, we obtain $y_2(t) = t^3$.

24. Set $y_2(t) = t v(t)$. Substitution into the ODE results in

$$t^2(tv'' + 2v') + 2t(tv' + v) - 2tv = 0.$$

After collecting terms, we end up with $t^3v'' + 4t^2v' = 0$. This equation is *linear* in the variable $w = v'$. It follows that $v'(t) = ct^{-4}$, and $v(t) = c_1t^{-3} + c_2$. Thus $y_2(t) = c_1t^{-2} + c_2t$. Setting $c_1 = 1$ and $c_2 = 0$, we obtain $y_2(t) = t^{-2}$.

26. Set $y_2(t) = tv(t)$. Substitution into the ODE results in $v'' - v' = 0$. This ODE is *linear* in the variable $w = v'$. It follows that $v'(t) = c_1e^t$, and $v(t) = c_1e^t + c_2$. Thus $y_2(t) = c_1te^t + c_2t$. Setting $c_1 = 1$ and $c_2 = 0$, we obtain $y_2(t) = te^t$.

28. Set $y_2(x) = e^xv(x)$. Substitution into the ODE results in

$$v'' + \frac{x-2}{x-1}v' = 0.$$

This ODE is *linear* in the variable $w = v'$. An integrating factor is

$$\begin{aligned}\mu &= \exp\left(\int \frac{x-2}{x-1}dx\right) \\ &= \frac{e^x}{x-1}.\end{aligned}$$

Rewrite the equation as $\left[\frac{e^xv'}{x-1}\right]' = 0$, from which it follows that $v'(x) = c(x-1)e^{-x}$. Hence $v(x) = c_1xe^{-x} + c_2$ and $y_2(x) = c_1x + c_2e^x$. Setting $c_1 = 1$ and $c_2 = 0$, we obtain $y_2(x) = x$.

29. Set $y_2(x) = y_1(x)v(x)$, in which $y_1(x) = x^{1/4}\exp(2\sqrt{x})$. It can be verified that y_1 is a solution of the ODE, that is, $x^2y_1'' - (x - 0.1875)y_1 = 0$. Substitution of the given form of y_2 results in the differential equation

$$2x^{9/4}v'' + (4x^{7/4} + x^{5/4})v' = 0.$$

This ODE is *linear* in the variable $w = v'$. An integrating factor is

$$\begin{aligned}\mu &= \exp\left(\int \left[2x^{-1/2} + \frac{1}{2x}\right]dx\right) \\ &= \sqrt{x}\exp(4\sqrt{x}).\end{aligned}$$

Rewrite the equation as $[\sqrt{x}\exp(4\sqrt{x})v']' = 0$, from which it follows that

$$v'(x) = c\exp(-4\sqrt{x})/\sqrt{x}.$$

Integrating, $v(x) = c_1\exp(-4\sqrt{x}) + c_2$ and as a result,

$$y_2(x) = c_1x^{1/4}\exp(-2\sqrt{x}) + c_2x^{1/4}\exp(2\sqrt{x}).$$

Setting $c_1 = 1$ and $c_2 = 0$, we obtain $y_2(x) = x^{1/4}\exp(-2\sqrt{x})$.

32. Direct substitution verifies that $y_1(t) = \exp(-\delta x^2/2)$ is a solution of the ODE. Now set $y_2(x) = y_1(x)v(x)$. Substitution of y_2 into the ODE results in

$$v'' - \delta x v' = 0.$$

This ODE is *linear* in the variable $w = v'$. An integrating factor is $\mu = \exp(-\delta x^2/2)$. Rewrite the equation as $[\exp(-\delta x^2/2)v']' = 0$, from which it follows that

$$v'(x) = c_1 \exp(\delta x^2/2).$$

Integrating, we obtain

$$v(x) = c_1 \int_{x_0}^x \exp(\delta u^2/2) du + v(x_0).$$

Hence

$$y_2(x) = c_1 \exp(-\delta x^2/2) \int_{x_0}^x \exp(\delta u^2/2) du + c_2 \exp(-\delta x^2/2).$$

Setting $c_2 = 0$, we obtain a second independent solution.

34. After writing the ODE in standard form, we have $p(t) = 3/t$. Based on *Abel's identity*, $W(y_1, y_2) = c_1 \exp(-\int \frac{3}{t} dt) = c_1 t^{-3}$. As shown in Prob. 33, two solutions of a second order linear equation satisfy

$$(y_2/y_1)' = W(y_1, y_2)/y_1^2.$$

In the given problem, $y_1(t) = t^{-1}$. Hence $(t y_2)' = c_1 t^{-1}$. Integrating both sides of the equation, $y_2(t) = c_1 t^{-1} \ln t + c_2 t^{-1}$.

36. After writing the ODE in standard form, we have $p(x) = -x/(x-1)$. Based on *Abel's identity*, $W(y_1, y_2) = c \exp(\int \frac{x}{x-1} dx) = c e^x(x-1)$. Two solutions of a second order linear equation satisfy

$$(y_2/y_1)' = W(y_1, y_2)/y_1^2.$$

In the given problem, $y_1(x) = e^x$. Hence $(e^{-x} y_2)' = c e^{-x}(x-1)$. Integrating both sides of the equation, $y_2(x) = c_1 x + c_2 e^x$. Setting $c_1 = 1$ and $c_2 = 0$, we obtain $y_2(x) = x$.

37. Write the ODE in standard form to find $p(x) = 1/x$. Based on *Abel's identity*, $W(y_1, y_2) = c \exp(-\int \frac{1}{x} dx) = c x^{-1}$. Two solutions of a second order linear ODE satisfy $(y_2/y_1)' = W(y_1, y_2)/y_1^2$. In the given problem, $y_1(x) = x^{-1/2} \sin x$. Hence

$$\left(\frac{\sqrt{x}}{\sin x} y_2 \right)' = c \frac{1}{\sin^2 x}.$$

Integrating both sides of the equation, $y_2(x) = c_1x^{-1/2}\cos x + c_2x^{-1/2}\sin x$. Setting $c_1 = 1$ and $c_2 = 0$, we obtain $y_2(x) = x^{-1/2}\cos x$.

39(a). The characteristic equation is $ar^2 + c = 0$. If $a, c > 0$, then the roots are $r_{1,2} = \pm i\sqrt{c/a}$. The general solution is

$$y(t) = c_1\cos\sqrt{\frac{c}{a}}t + c_2\sin\sqrt{\frac{c}{a}}t,$$

which is bounded.

(b). The characteristic equation is $ar^2 + br = 0$. The roots are $r_{1,2} = 0, -b/a$, and hence the general solution is $y(t) = c_1 + c_2\exp(-bt/a)$. Clearly, $y(t) \rightarrow c_1$.

40. Note that $\cos t \sin t = \frac{1}{2}\sin 2t$. So that $1 - k \cos t \sin t = 1 - \frac{k}{2}\sin 2t$. If $0 < k < 2$, then $\frac{k}{2}\sin 2t < |\sin 2t|$ and $-\frac{k}{2}\sin 2t > -|\sin 2t|$. Hence

$$\begin{aligned} 1 - k \cos t \sin t &= 1 - \frac{k}{2}\sin 2t \\ &> 1 - |\sin 2t| \\ &\geq 0. \end{aligned}$$

41. $p(t) = -3/t$ and $q(t) = 4/t^2$. We have $x = 2\int t^{-1}dt = 2\ln t$, and $t = e^{x/2}$. Furthermore,

$$\frac{q'(t) + 2p(t)q(t)}{2[q(t)]^{3/2}} = -2.$$

The ratio is constant, and therefore the equation can be transformed. In fact, we obtain

$$\frac{d^2y}{dx^2} - 2\frac{dy}{dx} + y = 0.$$

The general solution of this ODE is $y(x) = c_1e^x + c_2xe^x$. In terms of the original independent variable, $y(t) = c_1t^2 + c_2t^2\ln t$.

Section 3.6

2. The characteristic equation for the homogeneous problem is $r^2 + 2r + 5 = 0$, with complex roots $r = -1 \pm 2i$. Hence $y_c(t) = c_1 e^{-t} \cos 2t + c_2 e^{-t} \sin 2t$. Since the function $g(t) = 3 \sin 2t$ is not proportional to the solutions of the homogeneous equation, set $Y = A \cos 2t + B \sin 2t$. Substitution into the given ODE, and comparing the coefficients, results in the system of equations $B - 4A = 3$ and $A + 4B = 0$. Hence $Y = -\frac{12}{17} \cos 2t + \frac{3}{17} \sin 2t$. The general solution is $y(t) = y_c(t) + Y$.

3. The characteristic equation for the homogeneous problem is $r^2 - 2r - 3 = 0$, with roots $r = -1, 3$. Hence $y_c(t) = c_1 e^{-t} + c_2 e^{3t}$. Note that the assignment $Y = Ate^{-t}$ is *not* sufficient to match the coefficients. Try $Y = Ate^{-t} + Bt^2 e^{-t}$. Substitution into the differential equation, and comparing the coefficients, results in the system of equations $-4A + 2B = 0$ and $-8B = -3$. Hence $Y = \frac{3}{16} te^{-t} + \frac{3}{8} t^2 e^{-t}$. The general solution is $y(t) = y_c(t) + Y$.

5. The characteristic equation for the homogeneous problem is $r^2 + 9 = 0$, with complex roots $r = \pm 3i$. Hence $y_c(t) = c_1 \cos 3t + c_2 \sin 3t$. To simplify the analysis, set $g_1(t) = 6$ and $g_2(t) = t^2 e^{3t}$. By inspection, we have $Y_1 = 2/3$. Based on the form of g_2 , set $Y_2 = Ae^{3t} + Bte^{3t} + Ct^2 e^{3t}$. Substitution into the differential equation, and comparing the coefficients, results in the system of equations $18A + 6B + 2C = 0$, $18B + 12C = 0$, and $18C = 1$. Hence

$$Y_2 = \frac{1}{162} e^{3t} - \frac{1}{27} t e^{3t} + \frac{1}{18} t^2 e^{3t}.$$

The general solution is $y(t) = y_c(t) + Y_1 + Y_2$.

7. The characteristic equation for the homogeneous problem is $2r^2 + 3r + 1 = 0$, with roots $r = -1, -1/2$. Hence $y_c(t) = c_1 e^{-t} + c_2 e^{-t/2}$. To simplify the analysis, set $g_1(t) = t^2$ and $g_2(t) = 3 \sin t$. Based on the form of g_1 , set $Y_1 = A + Bt + Ct^2$. Substitution into the differential equation, and comparing the coefficients, results in the system of equations $A + 3B + 4C = 0$, $B + 6C = 0$, and $C = 1$. Hence we obtain $Y_1 = 14 - 6t + t^2$. On the other hand, set $Y_2 = D \cos t + E \sin t$. After substitution into the ODE, we find that $D = -9/10$ and $E = -3/10$. The general solution is $y(t) = y_c(t) + Y_1 + Y_2$.

9. The characteristic equation for the homogeneous problem is $r^2 + \omega_0^2 = 0$, with complex roots $r = \pm \omega_0 i$. Hence $y_c(t) = c_1 \cos \omega_0 t + c_2 \sin \omega_0 t$. Since $\omega \neq \omega_0$, set $Y = A \cos \omega t + B \sin \omega t$. Substitution into the ODE and comparing the coefficients results in the system of equations $(\omega_0^2 - \omega^2)A = 1$ and $(\omega_0^2 - \omega^2)B = 0$. Hence

$$Y = \frac{1}{\omega_0^2 - \omega^2} \cos \omega t.$$

The general solution is $y(t) = y_c(t) + Y$.

10. From Prob. 9, $y_c(t) = c$. Since $\cos \omega_0 t$ is a solution of the homogeneous problem, set $Y = At \cos \omega_0 t + Bt \sin \omega_0 t$. Substitution into the given ODE and comparing the coefficients results in $A = 0$ and $B = \frac{1}{2\omega_0}$. Hence the general solution is

$$y(t) = c_1 \cos \omega_0 t + c_2 \sin \omega_0 t + \frac{t}{2\omega_0} \sin \omega_0 t.$$

12. The characteristic equation for the homogeneous problem is $r^2 - r - 2 = 0$, with roots $r = -1, 2$. Hence $y_c(t) = c_1 e^{-t} + c_2 e^{2t}$. Based on the form of the right hand side, that is, $\cosh(2t) = (e^{2t} + e^{-2t})/2$, set $Y = At e^{2t} + B e^{-2t}$. Substitution into the given ODE and comparing the coefficients results in $A = 1/6$ and $B = 1/8$. Hence the general solution is $y(t) = c_1 e^{-t} + c_2 e^{2t} + t e^{2t}/6 + e^{-2t}/8$.

14. The characteristic equation for the homogeneous problem is $r^2 + 4 = 0$, with roots $r = \pm 2i$. Hence $y_c(t) = c_1 \cos 2t + c_2 \sin 2t$. Set $Y_1 = A + Bt + Ct^2$. Comparing the coefficients of the respective terms, we find that $A = -1/8, B = 0, C = 1/4$. Now set $Y_2 = D e^t$, and obtain $D = 3/5$. Hence the general solution is

$$y(t) = c_1 \cos 2t + c_2 \sin 2t - 1/8 + t^2/4 + 3 e^t/5.$$

Invoking the initial conditions, we require that $19/40 + c_1 = 0$ and $3/5 + 2c_2 = 2$. Hence $c_1 = -19/40$ and $c_2 = 7/10$.

15. The characteristic equation for the homogeneous problem is $r^2 - 2r + 1 = 0$, with a double root $r = 1$. Hence $y_c(t) = c_1 e^t + c_2 t e^t$. Consider $g_1(t) = t e^t$. Note that g_1 is a solution of the homogeneous problem. Set $Y_1 = At^2 e^t + Bt^3 e^t$ (the *first* term is not sufficient for a match). Upon substitution, we obtain $Y_1 = t^3 e^t/6$. By inspection, $Y_2 = 4$. Hence the general solution is $y(t) = c_1 e^t + c_2 t e^t + t^3 e^t/6 + 4$. Invoking the initial conditions, we require that $c_1 + 4 = 1$ and $c_1 + c_2 = 1$. Hence $c_1 = -3$ and $c_2 = 4$.

17. The characteristic equation for the homogeneous problem is $r^2 + 4 = 0$, with roots $r = \pm 2i$. Hence $y_c(t) = c_1 \cos 2t + c_2 \sin 2t$. Since the function $\sin 2t$ is a solution of the homogeneous problem, set $Y = At \cos 2t + Bt \sin 2t$. Upon substitution, we obtain $Y = -\frac{3}{4}t \cos 2t$. Hence the general solution is $y(t) = c_1 \cos 2t + c_2 \sin 2t - \frac{1}{4}t \cos 2t$. Invoking the initial conditions, we require that $c_1 = 2$ and $2c_2 - \frac{3}{4} = -1$. Hence $c_1 = 2$ and $c_2 = -1/8$.

18. The characteristic equation for the homogeneous problem is $r^2 + 2r + 5 = 0$, with complex roots $r = -1 \pm 2i$. Hence $y_c(t) = c_1 e^{-t} \cos 2t + c_2 e^{-t} \sin 2t$. Based on the form of $g(t)$, set $Y = At e^{-t} \cos 2t + Bt e^{-t} \sin 2t$. After comparing coefficients, we obtain $Y = t e^{-t} \sin 2t$. Hence the general solution is

$$y(t) = c_1 e^{-t} \cos 2t + c_2 e^{-t} \sin 2t + t e^{-t} \sin 2t.$$

Invoking the initial conditions, we require that $c_1 = 1$ and $-c_1 + 2c_2 = 0$. Hence $c_1 = 1$ and $c_2 = 1/2$.

20. The characteristic equation for the homogeneous problem is $r^2 + 1 = 0$, with complex roots $r = \pm i$. Hence $y_c(t) = c_1 \cos t + c_2 \sin t$. Let $g_1(t) = t \sin t$ and $g_2(t) = t$. By inspection, it is easy to see that $Y_2(t) = 1$. Based on the form of $g_1(t)$, set $Y_1(t) = At \cos t + Bt \sin t + Ct^2 \cos t + Dt^2 \sin t$. Substitution into the equation and comparing the coefficients results in $A = 0$, $B = 1/4$, $C = -1/4$, and $D = 0$. Hence $Y(t) = 1 + \frac{1}{4}t \sin t - \frac{1}{4}t^2 \cos t$.

21. The characteristic equation for the homogeneous problem is $r^2 - 5r + 6 = 0$, with roots $r = 2, 3$. Hence $y_c(t) = c_1 e^{2t} + c_2 e^{3t}$. Consider $g_1(t) = e^{2t}(3t + 4) \sin t$, and $g_2(t) = e^t \cos 2t$. Based on the form of these functions on the right hand side of the ODE,

set $Y_2(t) = e^t(A_1 \cos 2t + A_2 \sin 2t)$, $Y_1(t) = (B_1 + B_2 t)e^{2t} \sin t + (C_1 + C_2 t)e^{2t} \cos t$. Substitution into the equation and comparing the coefficients results in

$$Y(t) = -\frac{1}{20}(e^t \cos 2t + 3e^t \sin 2t) + \frac{3}{2}te^{2t}(\cos t - \sin t) + e^{2t}\left(\frac{1}{2}\cos t - 5\sin t\right).$$

23. The characteristic roots are $r = 2, 2$. Hence $y_c(t) = c_1 e^{2t} + c_2 t e^{2t}$. Consider the functions $g_1(t) = 2t^2$, $g_2(t) = 4te^{2t}$, and $g_3(t) = t \sin 2t$. The corresponding forms of the respective parts of the particular solution are $Y_1(t) = A_0 + A_1 t + A_2 t^2$, $Y_2(t) = e^{2t}(B_2 t^2 + B_3 t^3)$, and $Y_3(t) = t(C_1 \cos 2t + C_2 \sin 2t) + (D_1 \cos 2t + D_2 \sin 2t)$. Substitution into the equation and comparing the coefficients results in

$$Y(t) = \frac{1}{4}(3 + 4t + 2t^2) + \frac{2}{3}t^3 e^{2t} + \frac{1}{8}t \cos 2t + \frac{1}{16}(\cos 2t - \sin 2t).$$

24. The homogeneous solution is $y_c(t) = c_1 \cos 2t + c_2 \sin 2t$. Since $\cos 2t$ and $\sin 2t$ are both solutions of the homogeneous equation, set

$$Y(t) = t(A_0 + A_1 t + A_2 t^2) \cos 2t + t(B_0 + B_1 t + B_2 t^2) \sin 2t.$$

Substitution into the equation and comparing the coefficients results in

$$Y(t) = \left(\frac{13}{32}t - \frac{1}{12}t^3\right) \cos 2t + \frac{1}{16}(28t + 13t^2) \sin 2t.$$

25. The homogeneous solution is $y_c(t) = c_1 e^{-t} + c_2 t e^{-2t}$. None of the functions on the right hand side are solutions of the homogenous equation. In order to include all possible combinations of the derivatives, consider $Y(t) = e^t(A_0 + A_1 t + A_2 t^2) \cos 2t + e^t(B_0 + B_1 t + B_2 t^2) \sin 2t + e^{-t}(C_1 \cos t + C_2 \sin t) + D e^t$. Substitution into the differential equation and comparing the coefficients results in

$$Y(t) = e^t(A_0 + A_1 t + A_2 t^2) \cos 2t + e^t(B_0 + B_1 t + B_2 t^2) \sin 2t + e^{-t}\left(-\frac{2}{3} \cos t + \frac{2}{3} \sin t\right) + 2e^t/3,$$

in which $A_0 = -4105/35152$, $A_1 = 73/676$, $A_2 = -5/52$, $B_0 = -1233/35152$, $B_1 = 10/169$, $B_2 = 1/52$.

26. The homogeneous solution is $y_c(t) = c_1 e^{-t} \cos 2t + c_2 e^{-t} \sin 2t$. None of the terms on the right hand side are solutions of the homogenous equation. In order to include the appropriate combinations of derivatives, consider $Y(t) = e^{-t}(A_1 t + A_2 t^2) \cos 2t + e^{-t}(B_1 t + B_2 t^2) \sin 2t + e^{-2t}(C_0 + C_1 t) \cos 2t + e^{-2t}(D_0 + D_1 t) \sin 2t$. Substitution into the differential equation and comparing the coefficients results in

$$Y(t) = \frac{3}{16} t e^{-t} \cos 2t + \frac{3}{8} t^2 e^{-t} \sin 2t - \frac{1}{25} e^{-2t} (7 + 10t) \cos 2t + \frac{1}{25} e^{-2t} (1 + 5t) \sin 2t.$$

27. The homogeneous solution is $y_c(t) = c_1 \cos \lambda t + c_2 \sin \lambda t$. Since the differential operator does not contain a *first derivative* (and $\lambda \neq m\pi$), we can set

$$Y(t) = \sum_{m=1}^N C_m \sin m\pi t.$$

Substitution into the ODE yields

$$-\sum_{m=1}^N m^2 \pi^2 C_m \sin m\pi t + \lambda^2 \sum_{m=1}^N C_m \sin m\pi t = \sum_{m=1}^N a_m \sin m\pi t.$$

Equating coefficients of the individual terms, we obtain

$$C_m = \frac{a_m}{\lambda^2 - m^2 \pi^2}, \quad m = 1, 2 \dots N.$$

29. The homogeneous solution is $y_c(t) = c_1 e^{-t} \cos 2t + c_2 e^{-t} \sin 2t$. The input function is *independent* of the homogeneous solutions, on any interval. Since the right hand side is *piecewise constant*, it follows by inspection that

$$Y(t) = \begin{cases} 1/5, & 0 \leq t \leq \pi/2 \\ 0, & t > \pi/2 \end{cases}.$$

For $0 \leq t \leq \pi/2$, the general solution is $y(t) = c_1 e^{-t} \cos 2t + c_2 e^{-t} \sin 2t + 1/5$. Invoking the initial conditions $y(0) = y'(0) = 0$, we require that $c_1 = -1/5$, and that $c_2 = -1/10$. Hence

$$y(t) = \frac{1}{5} - \frac{1}{10} (2e^{-t} \cos 2t + e^{-t} \sin 2t)$$

on the interval $0 \leq t \leq \pi/2$. We now have the values $y(\pi/2) = (1 + e^{-\pi/2})/5$, and $y'(\pi/2) = 0$. For $t > \pi/2$, the general solution is $y(t) = d_1 e^{-t} \cos 2t + d_2 e^{-t} \sin 2t$. It follows that $y(\pi/2) = -e^{-\pi/2} d_1$ and $y'(\pi/2) = e^{-\pi/2} d_1 - 2e^{-\pi/2} d_2$. Since the

solution is continuously differentiable, we require that

$$\begin{aligned} -e^{-\pi/2}d_1 &= (1 + e^{-\pi/2})/5 \\ e^{-\pi/2}d_1 - 2e^{-\pi/2}d_2 &= 0. \end{aligned}$$

Solving for the coefficients, $d_1 = 2d_2 = -(e^{\pi/2} + 1)/5$.

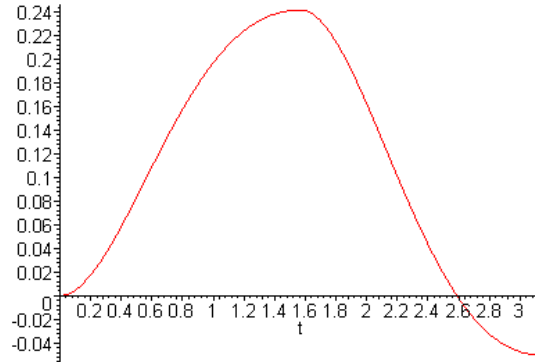

31. Since $a, b, c > 0$, the roots of the characteristic equation has *negative* real parts. That is, $r = \alpha \pm \beta i$, where $\alpha < 0$. Hence the homogeneous solution is

$$y_c(t) = c_1 e^{\alpha t} \cos \beta t + c_2 e^{\alpha t} \sin \beta t.$$

If $g(t) = d$, then the general solution is

$$y(t) = d/c + c_1 e^{\alpha t} \cos \beta t + c_2 e^{\alpha t} \sin \beta t.$$

Since $\alpha < 0$, $y(t) \rightarrow d/c$ as $t \rightarrow \infty$. If $c = 0$, then that characteristic roots are $r = 0$ and $r = -b/a$. The ODE becomes $ay'' + by' = d$. Integrating both sides, we find that $ay' + by = dt + c_1$. The general solution can be expressed as

$$y(t) = dt/b + c_1 + c_2 e^{-bt/a}.$$

In this case, the solution grows without bound. If $b = 0$, *also*, then the differential equation

can be written as $y'' = d/a$, which has general solution $y(t) = dt^2/2a + c_1 + c_2$.

Hence the assertion is true only if the coefficients are *positive*.

32(a). Since D is a linear operator,

$$\begin{aligned} D^2y + bDy + cy &= D^2y - (r_1 + r_2)Dy + r_1r_2y \\ &= D^2y - r_2Dy - r_1Dy + r_1r_2y \\ &= D(Dy - r_2y) - r_1(Dy - r_2y) \\ &= (D - r_1)(D - r_2)y. \end{aligned}$$

(b). Let $u = (D - r_2)y$. Then the ODE (i) can be written as $(D - r_1)u = g(t)$, that is,

$u' - r_1u = g(t)$. The latter is a linear *first order* equation in u . Its general solution is

$$u(t) = e^{r_1t} \int_{t_0}^t e^{-r_1\tau} g(\tau) d\tau + c_1 e^{r_1t}.$$

From above, we have $y' - r_2y = u(t)$. This equation is also a first order ODE. Hence the general solution of the original second order equation is

$$y(t) = e^{r_2t} \int_{t_0}^t e^{-r_2\tau} u(\tau) d\tau + c_2 e^{r_2t}.$$

Note that the solution $y(t)$ contains *two* arbitrary constants.

34. Note that $(2D^2 + 3D + 1)y = (2D + 1)(D + 1)y$. Let $u = (D + 1)y$, and solve the ODE $2u' + u = t^2 + 3\sin t$. This equation is a linear first order ODE, with solution

$$\begin{aligned} u(t) &= e^{-t/2} \int_{t_0}^t e^{\tau/2} \left[\tau^2/2 + \frac{3}{2} \sin \tau \right] d\tau + c e^{-t/2} \\ &= t^2 - 4t + 8 - \frac{6}{5} \cos t + \frac{3}{5} \sin t + c e^{-t/2}. \end{aligned}$$

Now consider the ODE $y' + y = u(t)$. The general solution of this first order ODE is

$$y(t) = e^{-t} \int_{t_0}^t e^{\tau} u(\tau) d\tau + c_2 e^{-t},$$

in which $u(t)$ is given above. Substituting for $u(t)$ and performing the integration,

$$y(t) = t^2 - 6t + 14 - \frac{9}{10} \cos t - \frac{3}{10} \sin t + c_1 e^{-t/2} + c_2 e^{-t}.$$

35. We have $(D^2 + 2D + 1)y = (D + 1)(D + 1)y$. Let $u = (D + 1)y$, and consider the ODE $u' + u = 2e^{-t}$. The general solution is $u(t) = 2te^{-t} + ce^{-t}$. We therefore have the first order equation $u' + u = 2te^{-t} + c_1e^{-t}$. The general solution of the latter differential equation is

$$\begin{aligned} y(t) &= e^{-t} \int_{t_0}^t [2\tau + c_1] d\tau + c_2 e^{-t} \\ &= e^{-t} (t^2 + c_1 t + c_2). \end{aligned}$$

36. We have $(D^2 + 2D)y = D(D + 2)y$. Let $u = (D + 2)y$, and consider the equation $u' = 3 + 4\sin 2t$. Direct integration results in $u(t) = 3t - 2\cos 2t + c$. The problem is reduced to solving the ODE $y' + 2y = 3t - 2\cos 2t + c$. The general solution of this first order differential equation is

$$\begin{aligned}y(t) &= e^{-2t} \int_{t_0}^t e^{2\tau} [3\tau - 2\cos 2\tau + c] d\tau + c_2 e^{-2t} \\ &= \frac{3}{2}t - \frac{1}{2}(\cos 2t + \sin 2t) + c_1 + c_2 e^{-2t}.\end{aligned}$$

Section 3.7

1. The solution of the homogeneous equation is $y_c(t) = c_1e^{2t} + c_2e^{3t}$. The functions $y_1(t) = e^{2t}$ and $y_2(t) = e^{3t}$ form a fundamental set of solutions. The Wronskian of these functions is $W(y_1, y_2) = e^{5t}$. Using the method of *variation of parameters*, the particular solution is given by $Y(t) = u_1(t)y_1(t) + u_2(t)y_2(t)$, in which

$$\begin{aligned} u_1(t) &= - \int \frac{e^{3t}(2e^t)}{W(t)} dt \\ &= 2e^{-t} \end{aligned}$$

$$\begin{aligned} u_2(t) &= \int \frac{e^{2t}(2e^t)}{W(t)} dt \\ &= -e^{-2t} \end{aligned}$$

Hence the particular solution is $Y(t) = 2e^t - e^t = e^t$.

3. The solution of the homogeneous equation is $y_c(t) = c_1e^{-t} + c_2te^{-t}$. The functions $y_1(t) = e^{-t}$ and $y_2(t) = te^{-t}$ form a fundamental set of solutions. The Wronskian of these functions is $W(y_1, y_2) = e^{-2t}$. Using the method of *variation of parameters*, the particular solution is given by $Y(t) = u_1(t)y_1(t) + u_2(t)y_2(t)$, in which

$$\begin{aligned} u_1(t) &= - \int \frac{te^{-t}(3e^{-t})}{W(t)} dt \\ &= -3t^2/2 \end{aligned}$$

$$\begin{aligned} u_2(t) &= \int \frac{e^{-t}(3e^{-t})}{W(t)} dt \\ &= 3t \end{aligned}$$

Hence the particular solution is $Y(t) = -3t^2e^{-t}/2 + 3te^{-t} = 3t^2e^{-t}/2$.

4. The functions $y_1(t) = e^{t/2}$ and $y_2(t) = te^{t/2}$ form a fundamental set of solutions. The Wronskian of these functions is $W(y_1, y_2) = e^t$. First write the equation in standard form, so that $g(t) = 4e^{t/2}$. Using the method of *variation of parameters*, the particular solution is given by $Y(t) = u_1(t)y_1(t) + u_2(t)y_2(t)$, in which

$$\begin{aligned} u_1(t) &= - \int \frac{te^{t/2}(4e^{t/2})}{W(t)} dt \\ &= -2t^2 \end{aligned}$$

$$\begin{aligned} u_2(t) &= \int \frac{e^{t/2}(4e^{t/2})}{W(t)} dt \\ &= 4t \end{aligned}$$

Hence the particular solution is $Y(t) = -2t^2e^{t/2} + 4t^2e^{t/2} = 2t^2e^{t/2}$.

6. The solution of the homogeneous equation is $y_c(t) = c_1 \cos 3t + c_2 \sin 3t$. The two functions $y_1(t) = \cos 3t$ and $y_2(t) = \sin 3t$ form a fundamental set of solutions, with $W(y_1, y_2) = 3$. The particular solution is given by $Y(t) = u_1(t)y_1(t) + u_2(t)y_2(t)$, in which

$$\begin{aligned} u_1(t) &= - \int \frac{\sin 3t(9 \sec^2 3t)}{W(t)} dt \\ &= - \csc 3t \end{aligned}$$

$$\begin{aligned} u_2(t) &= \int \frac{\cos 3t(9 \sec^2 3t)}{W(t)} dt \\ &= \ln|\sec 3t + \tan 3t| \end{aligned}$$

Hence the particular solution is $Y(t) = -1 + (\sin 3t)\ln|\sec 3t + \tan 3t|$. The general solution is given by $y(t) = c_1 \cos 3t + c_2 \sin 3t + (\sin 3t)\ln|\sec 3t + \tan 3t| - 1$.

7. The functions $y_1(t) = e^{-2t}$ and $y_2(t) = te^{-2t}$ form a fundamental set of solutions. The Wronskian of these functions is $W(y_1, y_2) = e^{-4t}$. The particular solution is given by $Y(t) = u_1(t)y_1(t) + u_2(t)y_2(t)$, in which

$$\begin{aligned} u_1(t) &= - \int \frac{te^{-2t}(t^{-2}e^{-2t})}{W(t)} dt \\ &= - \ln t \end{aligned}$$

$$\begin{aligned} u_2(t) &= \int \frac{e^{-2t}(t^{-2}e^{-2t})}{W(t)} dt \\ &= -1/t \end{aligned}$$

Hence the particular solution is $Y(t) = -e^{-2t} \ln t - e^{-2t}$. Since the *second term* is a solution of the homogeneous equation, the general solution is given by $y(t) = c_1 e^{-2t} + c_2 t e^{-2t} - e^{-2t} \ln t$.

8. The solution of the homogeneous equation is $y_c(t) = c_1 \cos 2t + c_2 \sin 2t$. The two functions $y_1(t) = \cos 2t$ and $y_2(t) = \sin 2t$ form a fundamental set of solutions, with $W(y_1, y_2) = 2$. The particular solution is given by $Y(t) = u_1(t)y_1(t) + u_2(t)y_2(t)$, in which

$$\begin{aligned} u_1(t) &= - \int \frac{\sin 2t(3 \csc 2t)}{W(t)} dt \\ &= - 3t/2 \end{aligned}$$

$$\begin{aligned} u_2(t) &= \int \frac{\cos 2t(3 \csc 2t)}{W(t)} dt \\ &= \frac{3}{4} \ln |\sin 2t| \end{aligned}$$

Hence the particular solution is $Y(t) = -\frac{3}{2}t \cos 2t + \frac{3}{4}(\sin 3t) \ln |\sin 2t|$. The general solution is given by $y(t) = c_1 \cos 2t + c_2 \sin 2t - \frac{3}{2}t \cos 2t + \frac{3}{4}(\sin 3t) \ln |\sin 2t|$.

9. The functions $y_1(t) = \cos(t/2)$ and $y_2(t) = \sin(t/2)$ form a fundamental set of solutions. The Wronskian of these functions is $W(y_1, y_2) = 1/2$. First write the ODE in standard form, so that $g(t) = \sec(t/2)/2$. The particular solution is given by $Y(t) = u_1(t)y_1(t) + u_2(t)y_2(t)$, in which

$$\begin{aligned} u_1(t) &= - \int \frac{\cos(t/2)[\sec(t/2)]}{2W(t)} dt \\ &= 2 \ln[\cos(t/2)] \end{aligned}$$

$$\begin{aligned} u_2(t) &= \int \frac{\sin(t/2)[\sec(t/2)]}{2W(t)} dt \\ &= t \end{aligned}$$

The particular solution is $Y(t) = 2\cos(t/2)\ln[\cos(t/2)] + t \sin(t/2)$. The general solution is given by

$$y(t) = c_1 \cos(t/2) + c_2 \sin(t/2) + 2 \cos(t/2) \ln[\cos(t/2)] + t \sin(t/2).$$

10. The solution of the homogeneous equation is $y_c(t) = c_1 e^t + c_2 t e^t$. The functions $y_1(t) = e^t$ and $y_2(t) = t e^t$ form a fundamental set of solutions, with $W(y_1, y_2) = e^{2t}$. The particular solution is given by $Y(t) = u_1(t)y_1(t) + u_2(t)y_2(t)$, in which

$$\begin{aligned} u_1(t) &= - \int \frac{t e^t (e^t)}{W(t)(1+t^2)} dt \\ &= - \frac{1}{2} \ln(1+t^2) \end{aligned}$$

$$\begin{aligned} u_2(t) &= \int \frac{e^t (e^t)}{W(t)(1+t^2)} dt \\ &= \arctan t \end{aligned}$$

The particular solution is $Y(t) = -\frac{1}{2}e^t \ln(1+t^2) + t e^t \arctan(t)$. Hence the general

solution is given by $y(t) = c_1 e^t + c_2 t e^t - \frac{1}{2} e^t \ln(1+t^2) + t e^t \arctan(t)$.

12. The functions $y_1(t) = \cos 2t$ and $y_2(t) = \sin 2t$ form a fundamental set of solutions, with $W(y_1, y_2) = 2$. The particular solution is given by $Y(t) = u_1(t) y_1(t) + u_2(t) y_2(t)$, in which

$$u_1(t) = -\frac{1}{2} \int^t g(s) \sin 2s \, ds$$

$$u_2(t) = \frac{1}{2} \int^t g(s) \cos 2s \, ds$$

Hence the particular solution is

$$Y(t) = -\frac{1}{2} \cos 2t \int^t g(s) \sin 2s \, ds + \frac{1}{2} \sin 2t \int^t g(s) \cos 2s \, ds.$$

Note that $\sin 2t \cos 2s - \cos 2t \sin 2s = \sin(2t - 2s)$. It follows that

$$Y(t) = \frac{1}{2} \int^t g(s) \sin(2t - 2s) \, ds.$$

The general solution of the differential equation is given by

$$y(t) = c_1 \cos 2t + c_2 \sin 2t + \frac{1}{2} \int^t g(s) \sin(2t - 2s) \, ds.$$

13. Note first that $p(t) = 0$, $q(t) = -2/t^2$ and $g(t) = (3t^2 - 1)/t^2$. The functions $y_1(t)$ and $y_2(t)$ are solutions of the homogeneous equation, verified by substitution. The Wronskian of these two functions is $W(y_1, y_2) = -3$. Using the method of *variation of parameters*, the particular solution is $Y(t) = u_1(t) y_1(t) + u_2(t) y_2(t)$, in which

$$\begin{aligned} u_1(t) &= -\int \frac{t^{-1}(3t^2 - 1)}{t^2 W(t)} dt \\ &= t^{-2}/6 + \ln t \end{aligned}$$

$$\begin{aligned} u_2(t) &= \int \frac{t^2(3t^2 - 1)}{t^2 W(t)} dt \\ &= -t^3/3 + t/3 \end{aligned}$$

Therefore $Y(t) = 1/6 + t^2 \ln t - t^2/3 + 1/3$. Hence the general solution is

$$y(t) = c_1 t^2 + c_2 t^{-1} + t^2 \ln t + 1/2.$$

15. Observe that $g(t) = t e^{2t}$. The functions $y_1(t)$ and $y_2(t)$ are a fundamental set of solutions. The Wronskian of these two functions is $W(y_1, y_2) = t e^t$. Using the method of *variation of parameters*, the particular solution is $Y(t) = u_1(t) y_1(t) + u_2(t) y_2(t)$, in which

$$\begin{aligned} u_1(t) &= - \int \frac{e^t (t e^{2t})}{W(t)} dt \\ &= - e^{2t} / 2 \end{aligned}$$

$$\begin{aligned} u_2(t) &= \int \frac{(1+t)(t e^{2t})}{W(t)} dt \\ &= t e^t \end{aligned}$$

Therefore $Y(t) = -(1+t)e^{2t}/2 + t e^{2t} = -e^{2t}/2 + t e^{2t}/2$.

16. Observe that $g(t) = 2(1-t)e^{-t}$. Direct substitution of $y_1(t) = e^t$ and $y_2(t) = t$ verifies that they are solutions of the homogeneous equation. The Wronskian of the two solutions is $W(y_1, y_2) = (1-t)e^t$. Using the method of *variation of parameters*, the particular solution is $Y(t) = u_1(t) y_1(t) + u_2(t) y_2(t)$, in which

$$\begin{aligned} u_1(t) &= - \int \frac{2t(1-t)e^{-t}}{W(t)} dt \\ &= t e^{-2t} + e^{-2t} / 2 \end{aligned}$$

$$\begin{aligned} u_2(t) &= \int \frac{2(1-t)}{W(t)} dt \\ &= -2e^{-t} \end{aligned}$$

Therefore $Y(t) = t e^{-t} + e^{-t} / 2 - 2t e^{-t} = -t e^{-t} + e^{-t} / 2$.

17. Note that $g(x) = \ln x$. The functions $y_1(x) = x^2$ and $y_2(x) = x^2 \ln x$ are solutions of the homogeneous equation, as verified by substitution. The Wronskian of the solutions is $W(y_1, y_2) = x^3$. Using the method of *variation of parameters*, the particular solution is

$$Y(x) = u_1(x) y_1(x) + u_2(x) y_2(x),$$

in which

$$\begin{aligned} u_1(x) &= - \int \frac{x^2 \ln x (\ln x)}{W(x)} dx \\ &= - (\ln x)^3 / 3 \end{aligned}$$

$$\begin{aligned} u_2(x) &= \int \frac{x^2(\ln x)}{W(x)} dx \\ &= (\ln x)^2/2 \end{aligned}$$

Therefore $Y(x) = -x^2(\ln x)^3/3 + x^2(\ln x)^3/2 = x^2(\ln x)^3/6$.

19. First write the equation in *standard form*. Note that the forcing function becomes $g(x)/(1-x)$. The functions $y_1(x) = e^x$ and $y_2(x) = x$ are a fundamental set of solutions,

as verified by substitution. The Wronskian of the solutions is $W(y_1, y_2) = (1-x)e^x$.

Using the method of *variation of parameters*, the particular solution is

$$Y(x) = u_1(x) y_1(x) + u_2(x) y_2(x),$$

in which

$$u_1(x) = - \int \frac{\tau(g(\tau))}{(1-\tau)W(\tau)} d\tau$$

$$u_2(x) = \int \frac{e^\tau(g(\tau))}{(1-\tau)W(\tau)} d\tau$$

Therefore

$$\begin{aligned} Y(x) &= -e^x \int \frac{\tau(g(\tau))}{(1-\tau)W(\tau)} d\tau + x \int \frac{e^\tau(g(\tau))}{(1-\tau)W(\tau)} d\tau \\ &= \int \frac{(xe^\tau - e^x\tau)g(\tau)}{(1-\tau)^2 e^\tau} d\tau. \end{aligned}$$

20. First write the equation in *standard form*. The forcing function becomes $g(x)/x^2$. The functions $y_1(x) = x^{-1/2}\sin x$ and $y_2(x) = x^{-1/2}\cos x$ are a fundamental set of solutions. The Wronskian of the solutions is $W(y_1, y_2) = -1/x$. Using the method of *variation of parameters*, the particular solution is

$$Y(x) = u_1(x) y_1(x) + u_2(x) y_2(x),$$

in which

$$u_1(x) = \int \frac{\cos \tau (g(\tau))}{\tau \sqrt{\tau}} d\tau$$

$$u_2(x) = - \int \frac{\sin \tau (g(\tau))}{\tau \sqrt{\tau}} d\tau$$

Therefore

$$\begin{aligned}
 Y(x) &= \frac{\sin x}{\sqrt{x}} \int^x \frac{\cos \tau (g(\tau))}{\tau \sqrt{\tau}} d\tau - \frac{\cos x}{\sqrt{x}} \int^x \frac{\sin \tau (g(\tau))}{\tau \sqrt{\tau}} d\tau \\
 &= \frac{1}{\sqrt{x}} \int^x \frac{\sin(x - \tau) g(\tau)}{\tau \sqrt{\tau}} d\tau.
 \end{aligned}$$

21. Let $y_1(t)$ and $y_2(t)$ be a fundamental set of solutions, and $W(t) = W(y_1, y_2)$ be the corresponding Wronskian. Any solution, $u(t)$, of the homogeneous equation is a linear combination $u(t) = \alpha_1 y_1(t) + \alpha_2 y_2(t)$. Invoking the initial conditions, we require that

$$\begin{aligned}
 y_0 &= \alpha_1 y_1(t_0) + \alpha_2 y_2(t_0) \\
 y'_0 &= \alpha_1 y'_1(t_0) + \alpha_2 y'_2(t_0)
 \end{aligned}$$

Note that this system of equations has a unique solution, since $W(t_0) \neq 0$. Now consider the *nonhomogeneous* problem, $L[v] = g(t)$, with *homogeneous* initial conditions. Using the method of variation of parameters, the particular solution is given by

$$Y(t) = -y_1(t) \int_{t_0}^t \frac{y_2(s) g(s)}{W(s)} ds + y_2(t) \int_{t_0}^t \frac{y_1(s) g(s)}{W(s)} ds.$$

The general solution of the IVP (iii) is

$$\begin{aligned}
 v(t) &= \beta_1 y_1(t) + \beta_2 y_2(t) + Y(t) \\
 &= \beta_1 y_1(t) + \beta_2 y_2(t) + y_1(t) u_1(t) + y_2(t) u_2(t)
 \end{aligned}$$

in which u_1 and u_2 are defined above. Invoking the initial conditions, we require that

$$\begin{aligned}
 0 &= \beta_1 y_1(t_0) + \beta_2 y_2(t_0) + Y(t_0) \\
 0 &= \beta_1 y'_1(t_0) + \beta_2 y'_2(t_0) + Y'(t_0)
 \end{aligned}$$

Based on the definition of u_1 and u_2 , $Y(t_0) = 0$. Furthermore, since $y_1 u'_1 + y_2 u'_2 = 0$, it follows that $Y'(t_0) = 0$. Hence the only solution of the above system of equations is the *trivial solution*. Therefore $v(t) = Y(t)$. Now consider the function $y = u + v$. Then $L[y] = L[u + v] = L[u] + L[v] = g(t)$. That is, $y(t)$ is a solution of the nonhomogeneous

problem. Further, $y(t_0) = u(t_0) + v(t_0) = y_0$, and similarly, $y'(t_0) = y'_0$. By the uniqueness theorems, $y(t)$ is the unique solution of the initial value problem.

23. A fundamental set of solutions is $y_1(t) = \cos t$ and $y_2(t) = \sin t$. The Wronskian $W(t) = y_1 y'_2 - y'_1 y_2 = 1$. By the result in Prob. 22,

$$\begin{aligned}
 Y(t) &= \int_{t_0}^t \frac{\cos(s) \sin(t) - \cos(t) \sin(s)}{W(s)} g(s) ds \\
 &= \int_{t_0}^t [\cos(s) \sin(t) - \cos(t) \sin(s)] g(s) ds.
 \end{aligned}$$

Finally, we have $\cos(s) \sin(t) - \cos(t) \sin(s) = \sin(t - s)$.

24. A fundamental set of solutions is $y_1(t) = e^{at}$ and $y_2(t) = e^{bt}$. The Wronskian $W(t) = y_1 y_2' - y_1' y_2 = (b - a) \exp[(a + b)t]$. By the result in Prob. 22,

$$\begin{aligned} Y(t) &= \int_{t_0}^t \frac{e^{as} e^{bt} - e^{at} e^{bs}}{W(s)} g(s) ds \\ &= \frac{1}{b - a} \int_{t_0}^t \frac{e^{as} e^{bt} - e^{at} e^{bs}}{\exp[(a + b)s]} g(s) ds. \end{aligned}$$

Hence the particular solution is

$$Y(t) = \frac{1}{b - a} \int_{t_0}^t [e^{b(t-s)} - e^{a(t-s)}] g(s) ds.$$

26. A fundamental set of solutions is $y_1(t) = e^{at}$ and $y_2(t) = te^{at}$. The Wronskian $W(t) = y_1 y_2' - y_1' y_2 = e^{2at}$. By the result in Prob. 22,

$$\begin{aligned} Y(t) &= \int_{t_0}^t \frac{e^{as} e^{bt} - e^{at} e^{bs}}{W(s)} g(s) ds \\ &= \frac{1}{b - a} \int_{t_0}^t \frac{e^{as} e^{bt} - e^{at} e^{bs}}{\exp[(a + b)s]} g(s) ds. \end{aligned}$$

Hence the particular solution is

$$Y(t) = \frac{1}{b - a} \int_{t_0}^t [e^{b(t-s)} - e^{a(t-s)}] g(s) ds.$$

26. A fundamental set of solutions is $y_1(t) = e^{at}$ and $y_2(t) = te^{at}$. The Wronskian $W(t) = y_1 y_2' - y_1' y_2 = e^{2at}$. By the result in Prob. 22,

$$\begin{aligned} Y(t) &= \int_{t_0}^t \frac{te^{as+at} - se^{at+as}}{W(s)} g(s) ds \\ &= \int_{t_0}^t \frac{(t - s)e^{as+at}}{e^{2as}} g(s) ds. \end{aligned}$$

Hence the particular solution is

$$Y(t) = \int_{t_0}^t (t - s)e^{a(t-s)} g(s) ds.$$

27. Depending on the values of a , b and c , the operator $aD^2 + bD + c$ can have *three* types of fundamental solutions.

(i) The characteristic roots $r_{1,2} = \alpha, \beta$; $\alpha \neq \beta$. $y_1(t) = e^{\alpha t}$ and $y_2(t) = e^{\beta t}$.

$$K(t) = \frac{1}{\beta - \alpha} [e^{\beta t} - e^{\alpha t}].$$

(ii) The characteristic roots $r_{1,2} = \alpha, \beta$; $\alpha = \beta$. $y_1(t) = e^{\alpha t}$ and $y_2(t) = te^{\alpha t}$.

$$K(t) = te^{\alpha t}.$$

(iii) The characteristic roots $r_{1,2} = \lambda \pm i\mu$. $y_1(t) = e^{\lambda t} \cos \mu t$ and $y_2(t) = e^{\lambda t} \sin \mu t$.

$$K(t) = \frac{1}{\mu} e^{\lambda t} \sin \mu t.$$

28. Let $y(t) = v(t)y_1(t)$, in which $y_1(t)$ is a solution of the *homogeneous equation*. Substitution into the given ODE results in

$$v''y_1 + 2v'y_1' + vy_1'' + p(t)[v'y_1 + vy_1'] + q(t)vy_1 = g(t).$$

By assumption, $y_1'' + p(t)y_1' + q(t)y_1 = 0$, hence $v(t)$ must be a solution of the ODE

$$v''y_1 + [2y_1' + p(t)y_1]v' = g(t).$$

Setting $w = v'$, we also have $w'y_1 + [2y_1' + p(t)y_1]w = g(t)$.

30. First write the equation as $y'' + 7t^{-1}y + 5t^{-2}y = t^{-1}$. As shown in Prob. 28, the function $y(t) = t^{-1}v(t)$ is a solution of the given ODE as long as v is a solution of

$$t^{-1}v'' + [-2t^{-2} + 7t^{-2}]v' = t^{-1},$$

that is, $v'' + 5t^{-1}v' = 1$. This ODE is *linear and first order* in v' . The integrating factor is $\mu = t^5$. The solution is $v' = t/6 + ct^{-5}$. Direct integration now results in $v(t) = t^2/12 + c_1t^{-4} + c_2$. Hence $y(t) = t/12 + c_1t^{-5} + c_2t^{-1}$.

31. Write the equation as $y'' - t^{-1}(1+t)y + t^{-1}y = te^{2t}$. As shown in Prob. 28, the function $y(t) = (1+t)v(t)$ is a solution of the given ODE as long as v is a solution of

$$(1+t)v'' + [2 - t^{-1}(1+t)^2]v' = te^{2t},$$

that is, $v'' - \frac{1+t^2}{t(t+1)}v' = \frac{t}{t+1}e^{2t}$. This equation is first order linear in v' , with integrating factor $\mu = t^{-1}(1+t)^2e^{-t}$. The solution is $v' = (t^2e^{2t} + c_1te^t)/(1+t)^2$. Integrating, we obtain $v(t) = e^{2t}/2 - e^{2t}/(t+1) + c_1e^t/(t+1) + c_2$. Hence the solution of the original ODE is $y(t) = (t-1)e^{2t}/2 + c_1e^t + c_2(t+1)$.

32. Write the equation as $y'' + t(1-t)^{-1}y - (1-t)^{-1}y = 2(1-t)e^{-t}$. The function $y(t) = e^tv(t)$ is a solution to the given ODE as long as v is a solution of

$$e^t v'' + [2e^t + t(1-t)^{-1}e^t]v' = 2(1-t)e^{-t},$$

that is, $v'' + [(2-t)/(1-t)]v' = 2(1-t)e^{-2t}$. This equation is first order linear in v' , with integrating factor $\mu = e^t/(t-1)$. The solution is

$$v' = (t-1)(2e^{-2t} + c_1e^{-t}).$$

Integrating, we obtain $v(t) = (1/2 - t)e^{-2t} - c_1te^{-t} + c_2$. Hence the solution of the original ODE is $y(t) = (1/2 - t)e^{-t} - c_1t + c_2e^t$.

Section 3.8

1. $R\cos\delta = 3$ and $R\sin\delta = 4 \Rightarrow R = \sqrt{25} = 5$ and $\delta = \arctan(4/3)$. Hence

$$u = 5 \cos(2t - 0.9273).$$

3. $R\cos\delta = 4$ and $R\sin\delta = -2 \Rightarrow R = \sqrt{20} = 2\sqrt{5}$ and $\delta = -\arctan(1/2)$. Hence

$$u = 2\sqrt{5} \cos(3t + 0.4636).$$

4. $R\cos\delta = -2$ and $R\sin\delta = -3 \Rightarrow R = \sqrt{13}$ and $\delta = \pi + \arctan(3/2)$. Hence

$$u = \sqrt{13} \cos(\pi t - 4.1244).$$

5. The spring constant is $k = 2/(1/2) = 4 \text{ lb/ft}$. Mass $m = 2/32 = 1/16 \text{ lb-s}^2/\text{ft}$. Since there is no damping, the equation of motion is

$$\frac{1}{16}u'' + 4u = 0,$$

that is, $u'' + 64u = 0$. The initial conditions are $u(0) = 1/4 \text{ ft}$, $u'(0) = 0 \text{ fps}$. The general solution is $u(t) = A \cos 8t + B \sin 8t$. Invoking the initial conditions, we have $u(t) = \frac{1}{4} \cos 8t$. $R = 3 \text{ inches}$, $\delta = 0 \text{ rad}$, $\omega_0 = 8 \text{ rad/s}$, and $T = \pi/4 \text{ sec}$.

7. The spring constant is $k = 3/(1/4) = 12 \text{ lb/ft}$. Mass $m = 3/32 \text{ lb-s}^2/\text{ft}$. Since there is no damping, the equation of motion is

$$\frac{3}{32}u'' + 12u = 0,$$

that is, $u'' + 128u = 0$. The initial conditions are $u(0) = -1/12 \text{ ft}$, $u'(0) = 2 \text{ fps}$. The general solution is $u(t) = A \cos 8\sqrt{2}t + B \sin 8\sqrt{2}t$. Invoking the initial conditions, we have

$$u(t) = -\frac{1}{12} \cos 8\sqrt{2}t + \frac{1}{4\sqrt{2}} \sin 8\sqrt{2}t.$$

$R = \sqrt{11}/12 \text{ ft}$, $\delta = \pi - \text{atan}(3/\sqrt{2}) \text{ rad}$, $\omega_0 = 8\sqrt{2} \text{ rad/s}$, and $T = \pi/(4\sqrt{2}) \text{ sec}$.

10. The spring constant is $k = 16/(1/4) = 64 \text{ lb/ft}$. Mass $m = 1/2 \text{ lb-s}^2/\text{ft}$. The damping coefficient is $\gamma = 2 \text{ lb-sec/ft}$. Hence the equation of motion is

$$\frac{1}{2}u'' + 2u' + 64u = 0,$$

that is, $u'' + 4u' + 128u = 0$. The initial conditions are $u(0) = 0 \text{ ft}$, $u'(0) = 1/4 \text{ fps}$. The general solution is $u(t) = A \cos 2\sqrt{31}t + B \sin 2\sqrt{31}t$. Invoking the initial conditions, we have

$$u(t) = \frac{1}{8\sqrt{31}} e^{-2t} \sin 2\sqrt{31}t.$$

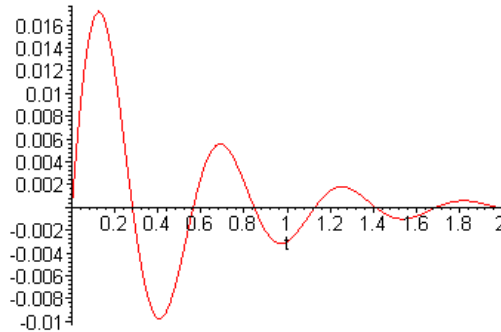

Solving $u(t) = 0$, on the interval $[0.2, 0.4]$, we obtain $t = \pi/2\sqrt{31} = 0.2821 \text{ sec}$. Based on the graph, and the solution of $u(t) = 0.01$, we have $|u(t)| \leq 0.01$ for $t \geq \tau = 0.2145$.

11. The spring constant is $k = 3/(.1) = 30 \text{ N/m}$. The damping coefficient is given as $\gamma = 3/5 \text{ N-sec/m}$. Hence the equation of motion is

$$2u'' + \frac{3}{5}u' + 30u = 0,$$

that is, $u'' + 0.3u' + 15u = 0$. The initial conditions are $u(0) = 0.05 \text{ m}$ and $u'(0) = 0.01 \text{ m/s}$. The general solution is $u(t) = A \cos \mu t + B \sin \mu t$, in which $\mu = 3.87008 \text{ rad/s}$. Invoking the initial conditions, we have

$$u(t) = e^{-0.15t}(0.05 \cos \mu t + 0.00452 \sin \mu t).$$

Also, $\mu/\omega_0 = 3.87008/\sqrt{15} \approx 0.99925$.

13. The frequency of the *undamped* motion is $\omega_0 = 1$. The quasi frequency of the damped motion is $\mu = \frac{1}{2}\sqrt{4 - \gamma^2}$. Setting $\mu = \frac{2}{3}\omega_0$, we obtain $\gamma = \frac{2}{3}\sqrt{5}$.

14. The spring constant is $k = mg/L$. The equation of motion for an undamped system is

$$mu'' + \frac{mg}{L}u = 0.$$

Hence the natural frequency of the system is $\omega_0 = \sqrt{\frac{g}{L}}$. The period is $T = 2\pi/\omega_0$.

15. The general solution of the system is $u(t) = A \cos \gamma(t - t_0) + B \sin \gamma(t - t_0)$. Invoking the initial conditions, we have $u(t) = u_0 \cos \gamma(t - t_0) + (u'_0/\gamma) \sin \gamma(t - t_0)$. Clearly, the functions $v = u_0 \cos \gamma(t - t_0)$ and $w = (u'_0/\gamma) \sin \gamma(t - t_0)$ satisfy the given criteria.

16. Note that $r \sin(\omega_0 t - \theta) = r \sin \omega_0 t \cos \theta - r \cos \omega_0 t \sin \theta$. Comparing the given expressions, we have $A = -r \sin \theta$ and $B = r \cos \theta$. That is, $r = R = \sqrt{A^2 + B^2}$, and $\tan \theta = -A/B = -1/\tan \delta$. The latter relation is also $\tan \theta + \cot \delta = 1$.

18. The system is *critically damped*, when $R = 2\sqrt{L/C}$. Here $R = 1000$ ohms.

21(a). Let $u = Re^{-\gamma t/2m} \cos(\mu t - \delta)$. Then attains a *maximum* when $\mu t_k - \delta = 2k\pi$. Hence $T_d = t_{k+1} - t_k = 2\pi/\mu$.

(b). $u(t_k)/u(t_{k+1}) = \exp(-\gamma t_k/2m)/\exp(-\gamma t_{k+1}/2m) = \exp[(\gamma t_{k+1} - \gamma t_k)/2m]$.
Hence $u(t_k)/u(t_{k+1}) = \exp[\gamma(2\pi/\mu)/2m] = \exp(\gamma T_d/2m)$.

(c). $\Delta = \ln[u(t_k)/u(t_{k+1})] = \gamma(2\pi/\mu)/2m = \pi\gamma/\mu m$.

22. The spring constant is $k = 16/(1/4) = 64$ lb/ft. Mass $m = 1/2$ lb-s²/ft. The damping coefficient is $\gamma = 2$ lb-sec/ft. The quasi frequency is $\mu = 2\sqrt{31}$ rad/s. Hence $\Delta = \frac{2\pi}{\sqrt{31}} \approx 1.1285$.

25(a). The solution of the IVP is $u(t) = e^{-t/8} \left(2 \cos \frac{3}{8} \sqrt{7} t + 0.252 \sin \frac{3}{8} \sqrt{7} t \right)$.

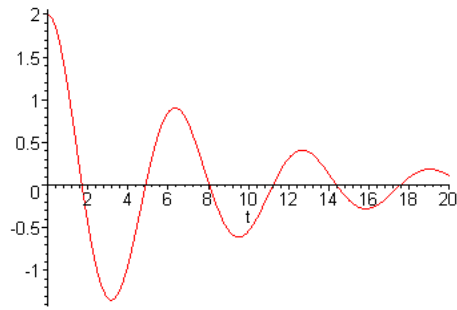

Using the plot, and numerical analysis, $\tau \approx 41.715$.

(b). For $\gamma = 0.5$, $\tau \approx 20.402$; for $\gamma = 1.0$, $\tau \approx 9.168$; for $\gamma = 1.5$, $\tau \approx 7.184$.

(c).

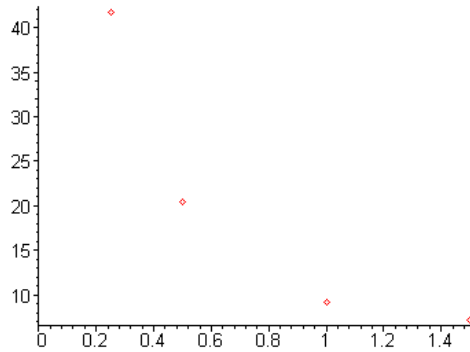

(d). For $\gamma = 1.6$, $\tau \approx 7.218$; for $\gamma = 1.7$, $\tau \approx 6.767$; for $\gamma = 1.8$, $\tau \approx 5.473$; for $\gamma = 1.9$, $\tau \approx 6.460$. τ steadily decreases to about $\tau_{min} \approx 4.873$, corresponding to the critical value $\gamma_0 \approx 1.73$.

(e). We have $u(t) = \frac{4e^{-\gamma t/2}}{\sqrt{4-\gamma^2}} \cos(\mu t - \delta)$, in which $\mu = \frac{1}{2}\sqrt{4-\gamma^2}$, and $\delta = \tan^{-1} \frac{\gamma}{\sqrt{4-\gamma^2}}$. Hence $|u(t)| \leq \frac{4e^{-\gamma t/2}}{\sqrt{4-\gamma^2}}$.

26(a). The characteristic equation is $mr^2 + \gamma r + k = 0$. Since $\gamma^2 < 4km$, the roots are $r_{1,2} = -\frac{\gamma}{2m} \pm i \frac{\sqrt{4mk-\gamma^2}}{2m}$. The general solution is

$$u(t) = e^{-\gamma t/2m} \left[A \cos \frac{\sqrt{4mk-\gamma^2}}{2m} t + B \sin \frac{\sqrt{4mk-\gamma^2}}{2m} t \right].$$

Invoking the initial conditions, $A = u_0$ and

$$B = \frac{(2mv_0 - \gamma u_0)}{\sqrt{4mk - \gamma^2}}.$$

(b). We can write $u(t) = R e^{-\gamma t/2m} \cos(\mu t - \delta)$, in which

$$R = \sqrt{u_0^2 + \frac{(2mv_0 - \gamma u_0)^2}{4mk - \gamma^2}},$$

and

$$\delta = \arctan \left[\frac{(2mv_0 - \gamma u_0)}{u_0 \sqrt{4mk - \gamma^2}} \right].$$

(c). $R = \sqrt{u_0^2 + \frac{(2mv_0 - \gamma u_0)^2}{4mk - \gamma^2}} = 2\sqrt{\frac{m(ku_0^2 + \gamma u_0 v_0 + mv_0^2)}{4mk - \gamma^2}} = \sqrt{\frac{a+b\gamma}{4mk - \gamma^2}}.$

It is evident that R increases (*monotonically*) without bound as $\gamma \rightarrow (2\sqrt{mk})^-$.

28(a). The general solution is $u(t) = A \cos \sqrt{2}t + B \sin \sqrt{2}t$. Invoking the initial conditions, we have $u(t) = \sqrt{2} \sin \sqrt{2}t$.

(b).

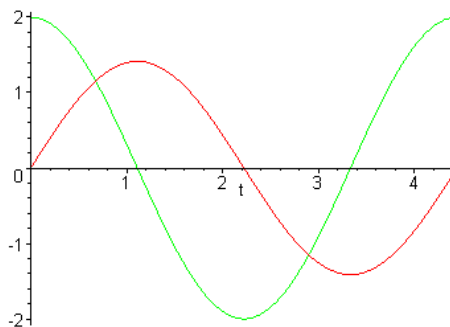

(c).

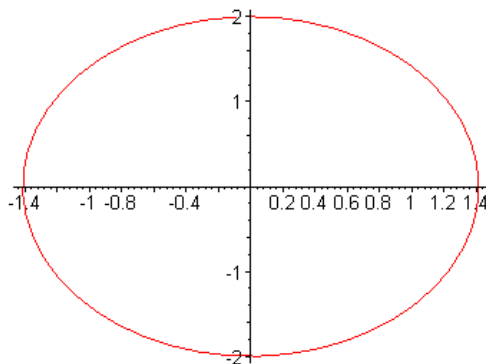

The condition $u'(0) = 2$ implies that $u(t)$ *initially* increases. Hence the phase point travels *clockwise*.

29. $u(t) = \frac{16}{\sqrt{127}} e^{-t/8} \sin \frac{\sqrt{127}}{8} t.$

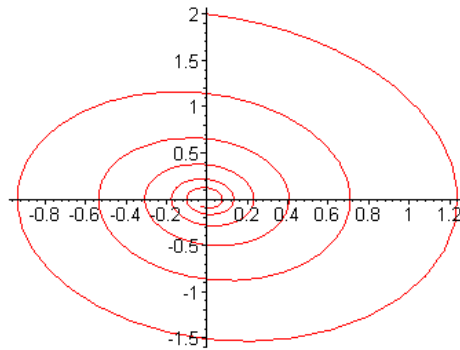

31. Based on *Newton's second law*, with the positive direction to the right,

$$\sum F = mu''$$

where

$$\sum F = -ku - \gamma u'.$$

Hence the equation of motion is $mu'' + \gamma u' + ku = 0$. The only difference in this problem is that the equilibrium position is located at the *unstretched* configuration of the spring.

32(a). The *restoring* force exerted by the spring is $F_s = -(ku + \varepsilon u^3)$. The *opposing* viscous force is $F_d = -\gamma u'$. Based on *Newton's second law*, with the positive direction to the right,

$$F_s + F_d = mu''.$$

Hence the equation of motion is $mu'' + \gamma u' + ku + \varepsilon u^3 = 0$.

(b). With the specified parameter values, the equation of motion is $u'' + u = 0$. The general solution of this ODE is $u(t) = A \cos t + B \sin t$. Invoking the initial conditions, the specific solution is $u(t) = \sin t$. Clearly, the amplitude is $R = 1$, and the period of the motion is $T = 2\pi$.

(c). Given $\varepsilon = 0.1$, the equation of motion is $u'' + u + 0.1 u^3 = 0$. A solution of the

IVP can be generated numerically:

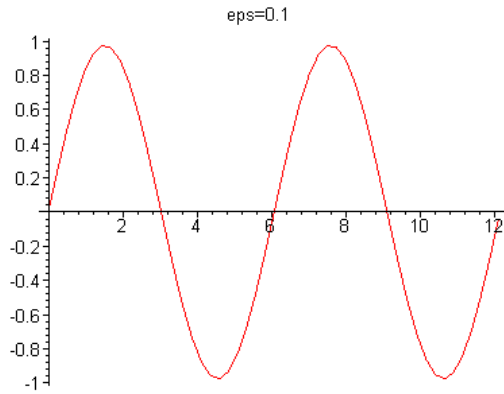

(d).

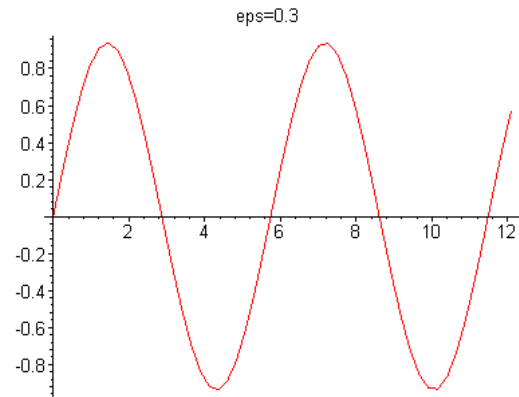
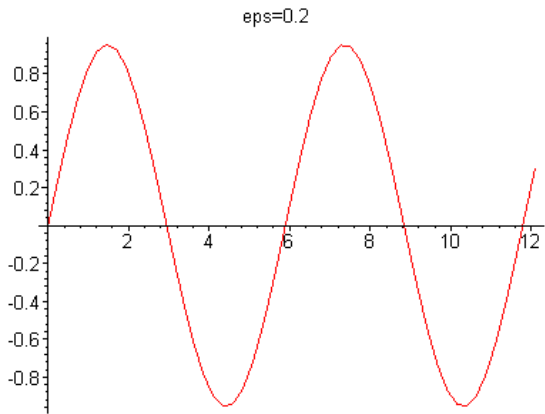

(e). The amplitude and period both seem to *decrease*.

(f).

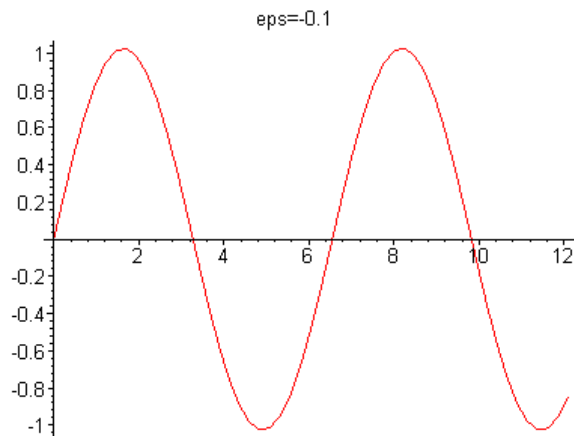

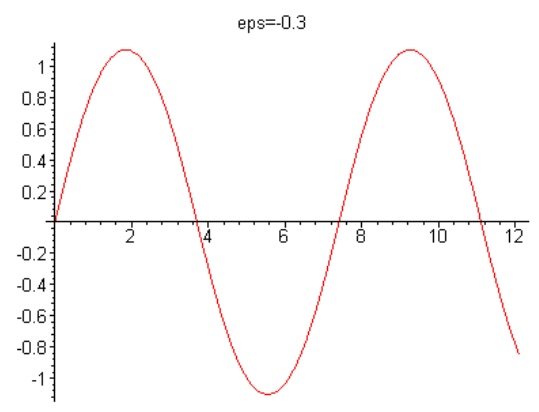
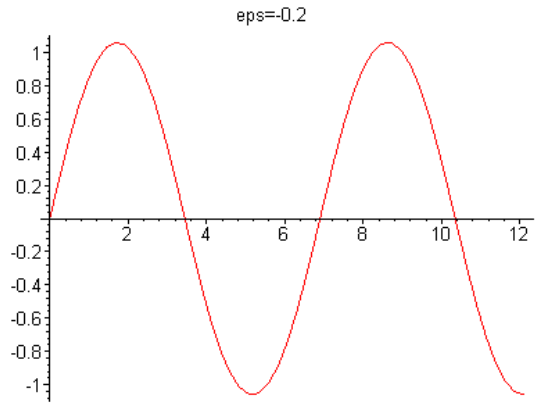

Section 3.9

2. We have $\sin(\alpha \pm \beta) = \sin \alpha \cos \beta \pm \cos \alpha \sin \beta$. Subtracting the two identities, we obtain $\sin(\alpha + \beta) - \sin(\alpha - \beta) = 2 \cos \alpha \sin \beta$. Setting $\alpha + \beta = 7t$ and $\alpha - \beta = 6t$, $\alpha = 6.5t$ and $\beta = 0.5t$. Hence $\sin 7t - \sin 6t = 2 \sin \frac{t}{2} \cos \frac{13t}{2}$.

3. Consider the trigonometric identity $\cos(\alpha \pm \beta) = \cos \alpha \cos \beta \mp \sin \alpha \sin \beta$. Adding the two identities, we obtain $\cos(\alpha - \beta) + \cos(\alpha + \beta) = 2 \cos \alpha \cos \beta$. Comparing the expressions, set $\alpha + \beta = 2\pi t$ and $\alpha - \beta = \pi t$. Hence $\alpha = 3\pi t/2$ and $\beta = \pi t/2$. Upon substitution, we have $\cos(\pi t) + \cos(2\pi t) = 2 \cos(3\pi t/2) \cos(\pi t/2)$.

4. Adding the two identities $\sin(\alpha \pm \beta) = \sin \alpha \cos \beta \pm \cos \alpha \sin \beta$, it follows that $\sin(\alpha - \beta) + \sin(\alpha + \beta) = 2 \sin \alpha \cos \beta$. Setting $\alpha + \beta = 4t$ and $\alpha - \beta = 3t$, we have $\alpha = 7t/2$ and $\beta = t/2$. Hence $\sin 3t + \sin 4t = 2 \sin(7t/2) \cos(t/2)$.

6. Using *mks* units, the spring constant is $k = 5(9.8)/0.1 = 490 \text{ N/m}$, and the damping coefficient is $\gamma = 2/0.04 = 50 \text{ N-sec/m}$. The equation of motion is

$$5u'' + 50u' + 490u = 10 \sin(t/2).$$

The initial conditions are $u(0) = 0 \text{ m}$ and $u'(0) = 0.03 \text{ m/s}$.

8(a). The homogeneous solution is $u_c(t) = Ae^{-5t} \cos \sqrt{73}t + Be^{-5t} \sin \sqrt{73}t$. Based on the method of *undetermined coefficients*, the particular solution is

$$U(t) = \frac{1}{153281} [-160 \cos(t/2) + 3128 \sin(t/2)].$$

Hence the general solution of the ODE is $u(t) = u_c(t) + U(t)$. Invoking the initial conditions, we find that $A = 160/153281$ and $B = 383443\sqrt{73}/1118951300$. Hence the response is

$$u(t) = \frac{1}{153281} \left[160 e^{-5t} \cos \sqrt{73}t + \frac{383443\sqrt{73}}{7300} e^{-5t} \sin \sqrt{73}t \right] + U(t).$$

(b). $u_c(t)$ is the transient part and $U(t)$ is the steady state part of the response.

(c).

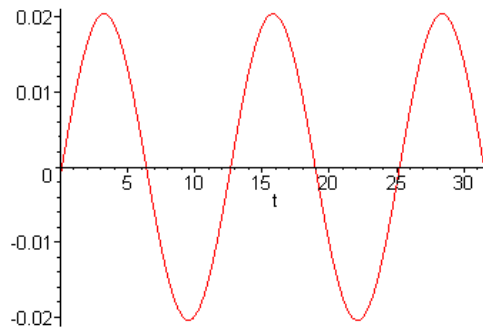

(d). Based on Eqs. (9) and (10), the amplitude of the forced response is given by $R = 2/\Delta$, in which

$$\Delta = \sqrt{25(98 - \omega^2)^2 + 2500\omega^2}.$$

The maximum amplitude is attained when Δ is a *minimum*. Hence the amplitude is maximum at $\omega = 4\sqrt{3}$ rad/s.

9. The spring constant is $k = 12$ lb/ft and hence the equation of motion is

$$\frac{6}{32}u'' + 12u = 4 \cos 7t,$$

that is, $u'' + 64u = \frac{64}{3} \cos 7t$. The initial conditions are $u(0) = 0$ ft, $u'(0) = 0$ fps. The general solution is $u(t) = A \cos 8t + B \sin 8t + \frac{64}{45} \cos 7t$. Invoking the initial conditions, we have $u(t) = -\frac{64}{45} \cos 8t + \frac{64}{45} \cos 7t = \frac{128}{45} \sin(t/2) \sin(15t/2)$.

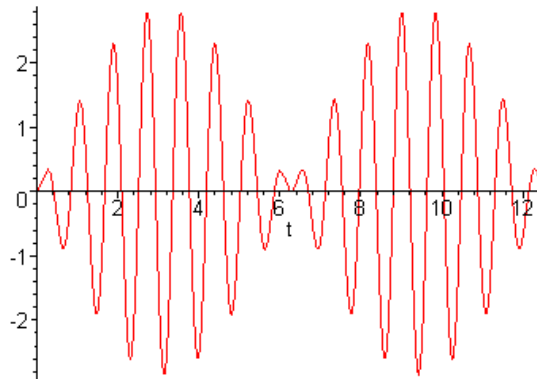

12. The equation of motion is

$$2u'' + u' + 3u = 3 \cos 3t - 2 \sin 3t.$$

Since the system is *damped*, the steady state response is equal to the particular solution. Using the method of *undetermined coefficients*, we obtain

$$u_{ss}(t) = \frac{1}{6}(\sin 3t - \cos 3t).$$

Further, we find that $R = \sqrt{2}/6$ and $\delta = \arctan(-1) = 3\pi/4$. Hence we can write $u_{ss}(t) = \frac{\sqrt{2}}{6}\cos(3t - 3\pi/4)$.

13. The amplitude of the steady-state response is given by

$$R = \frac{F_0}{\sqrt{m^2(\omega_0^2 - \omega^2)^2 + \gamma^2 \omega^2}}.$$

Since F_0 is constant, the amplitude is *maximum* when the denominator of R is *minimum*. Let $z = \omega^2$, and consider the function $f(z) = m^2(\omega_0^2 - z)^2 + \gamma^2 z$. Note that $f(z)$ is a quadratic, with *minimum* at $z = \omega_0^2 - \gamma^2/2m^2$. Hence the amplitude R attains a maximum at $\omega_{max}^2 = \omega_0^2 - \gamma^2/2m^2$. Furthermore, since $\omega_0^2 = k/m$, and therefore

$$\omega_{max}^2 = \omega_0^2 \left[1 - \frac{\gamma^2}{2km} \right].$$

Substituting $\omega^2 = \omega_{max}^2$ into the expression for the amplitude,

$$\begin{aligned} R &= \frac{F_0}{\sqrt{\gamma^4/4m^2 + \gamma^2(\omega_0^2 - \gamma^2/2m^2)}} \\ &= \frac{F_0}{\sqrt{\omega_0^2 \gamma^2 - \gamma^4/4m^2}} \\ &= \frac{F_0}{\gamma \omega_0 \sqrt{1 - \gamma^2/4mk}}. \end{aligned}$$

14(a). The forced response is $u_{ss}(t) = A\cos \omega t + B\sin \omega t$. The constants are obtain by the method of *undetermined coefficients*. That is, comparing the coefficients of $\cos \omega t$ and $\sin \omega t$, we find that

$$-m\omega^2 A + \gamma\omega B + kA = F_0, \text{ and } -m\omega^2 B - \gamma\omega A + kB = 0.$$

Solving this system results in

$$A = m(\omega_0^2 - \omega^2)/\Delta \text{ and } B = \gamma\omega/\Delta,$$

in which $\Delta = \sqrt{m^2(\omega_0^2 - \omega^2)^2 + \gamma^2 \omega^2}$. It follows that

$$\tan \delta = B/A = \frac{\gamma\omega}{m(\omega_0^2 - \omega^2)}.$$

(b). Here $m = 1$, $\gamma = 0.125$, $\omega_0 = 1$. Hence $\tan \delta = 0.125\omega/(1 - \omega^2)$.

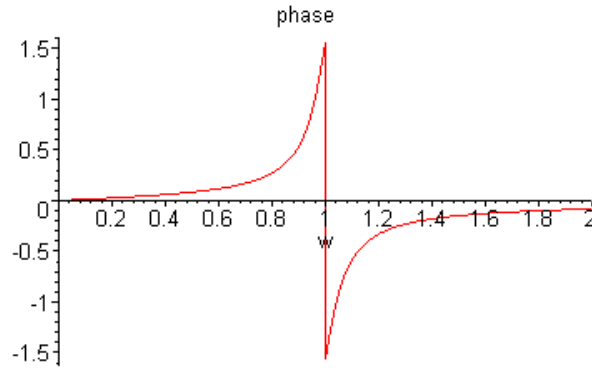

17(a). Here $m = 1$, $\gamma = 0.25$, $\omega_0^2 = 2$, $F_0 = 2$. Hence $u_{ss}(t) = \frac{2}{\Delta} \cos(\omega t - \delta)$, where $\Delta = \sqrt{(2 - \omega^2)^2 + \omega^2/16} = \frac{1}{4} \sqrt{64 - 63\omega^2 + 16\omega^4}$, and $\tan \delta = \frac{\omega}{4(2 - \omega^2)}$.

(b). The amplitude is

$$R = \frac{8}{\sqrt{64 - 63\omega^2 + 16\omega^4}}.$$

(c).

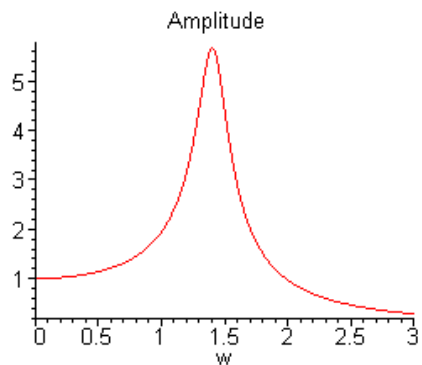

(d). See Prob. 13. The amplitude is maximum when the denominator of R is minimum. That is, when $\omega = \omega_{max} = 3\sqrt{14}/8 \approx 1.4031$. Hence $R(\omega = \omega_{max}) = 64/\sqrt{127}$.

18(a). The homogeneous solution is $u_c(t) = A \cos t + B \sin t$. Based on the method of *undetermined coefficients*, the particular solution is

$$U(t) = \frac{3}{1 - \omega^2} \cos \omega t.$$

Hence the general solution of the ODE is $u(t) = u_c(t) + U(t)$. Invoking the initial conditions, we find that $A = 3/(\omega^2 - 1)$ and $B = 0$. Hence the response is

$$u(t) = \frac{3}{1 - \omega^2} [\cos \omega t - \cos t].$$

(b).

$\omega = 0.7$

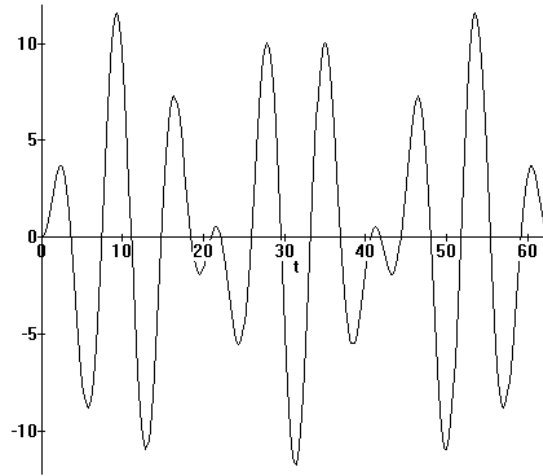

$\omega = 0.8$

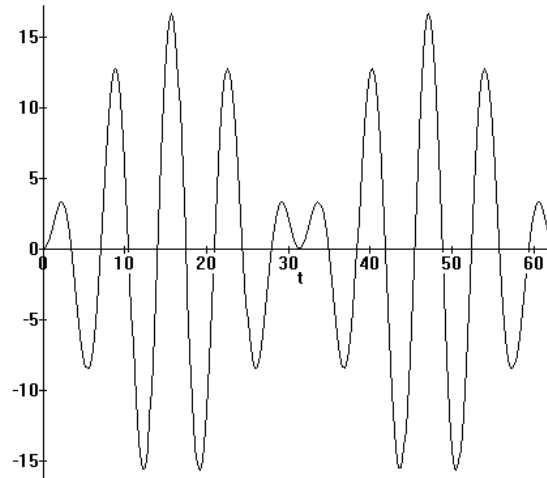

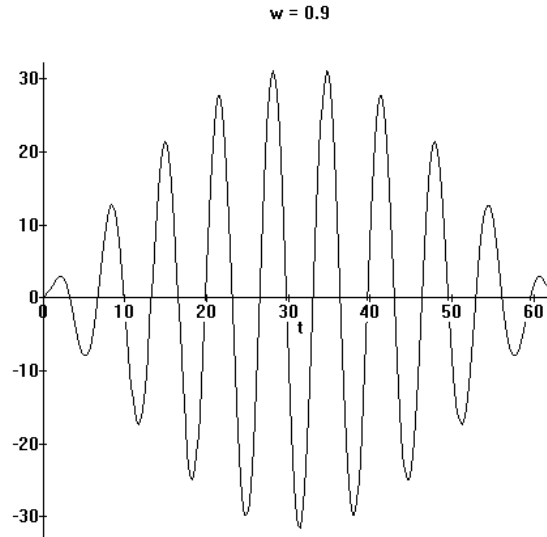

Note that

$$u(t) = \frac{6}{1 - \omega^2} \sin \left[\frac{(1 - \omega)t}{2} \right] \sin \left[\frac{(\omega + 1)t}{2} \right].$$

19(a). The homogeneous solution is $u_c(t) = A \cos t + B \sin t$. Based on the method of *undetermined coefficients*, the particular solution is

$$U(t) = \frac{3}{1 - \omega^2} \cos \omega t.$$

Hence the general solution is $u(t) = u_c(t) + U(t)$. Invoking the initial conditions, we find that $A = (\omega^2 + 2)/(\omega^2 - 1)$ and $B = 1$. Hence the response is

$$u(t) = \frac{1}{1 - \omega^2} [3 \cos \omega t - (\omega^2 + 2) \cos t] + \sin t.$$

(b.)

$w = 0.7$

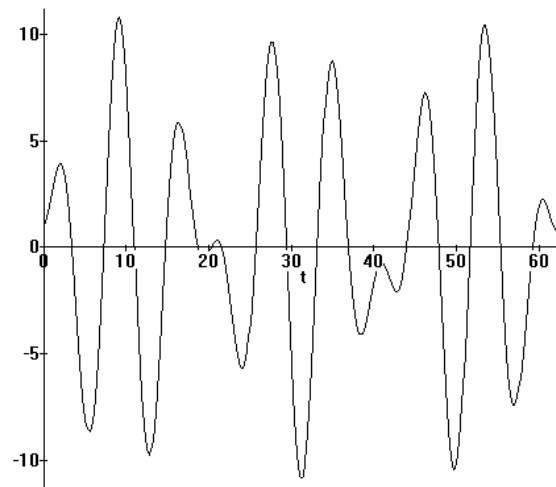

$w = 0.8$

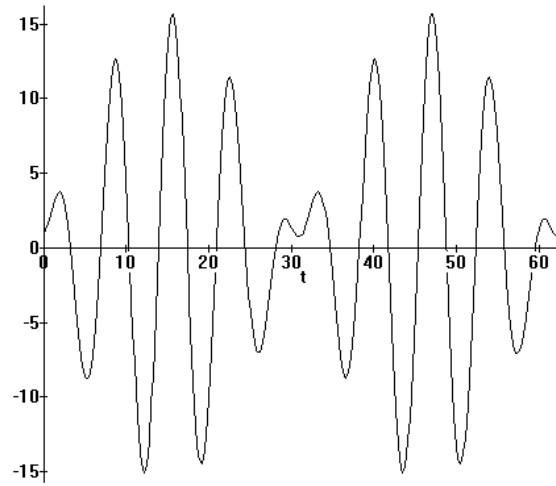

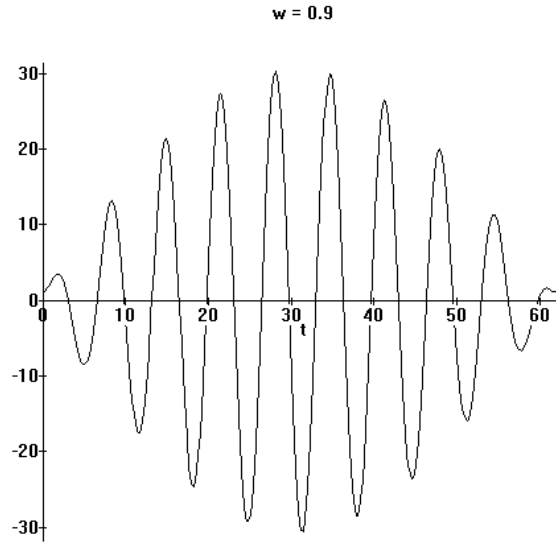

Note that

$$u(t) = \frac{6}{1 - \omega^2} \sin\left[\frac{(1 - \omega)t}{2}\right] \sin\left[\frac{(\omega + 1)t}{2}\right] + \cos t + \sin t.$$

20.

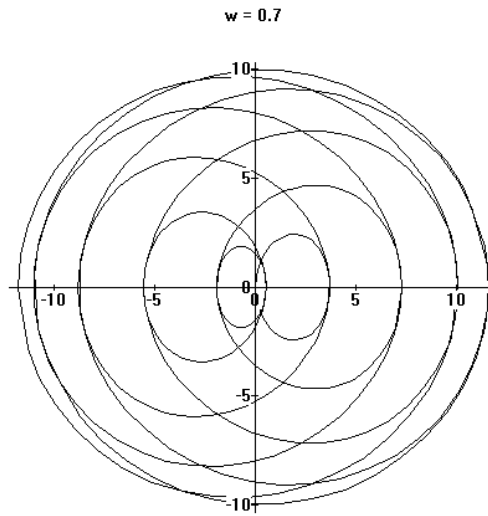

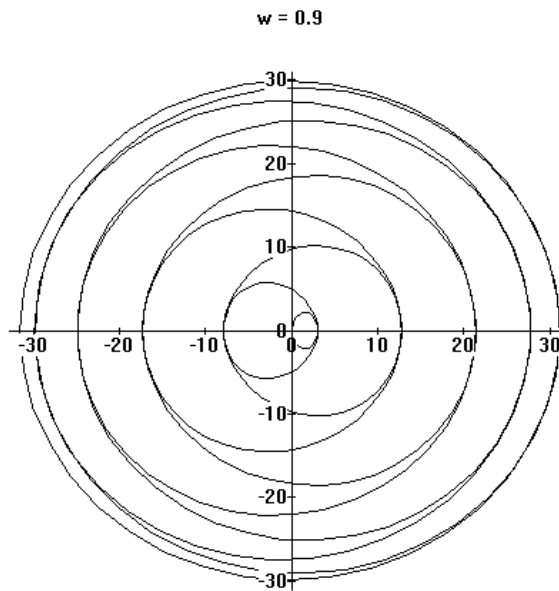
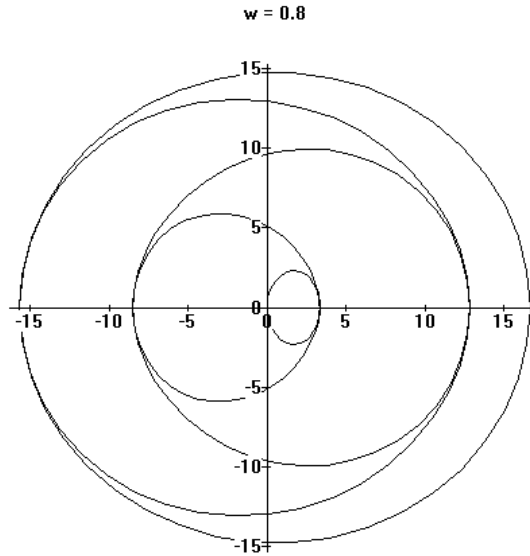

21. The general solution is $u(t) = u_c(t) + U(t)$, in which

$$u_c(t) = e^{-t/16} \left[-\frac{171358}{132721} \cos \frac{\sqrt{255}}{16} t - \frac{257758}{132721\sqrt{255}} \sin \frac{\sqrt{255}}{16} t \right]$$

and

$$U(t) = \frac{1}{132721} [436800 \cos(.3t) + 18000 \sin(.3t)].$$

(a).

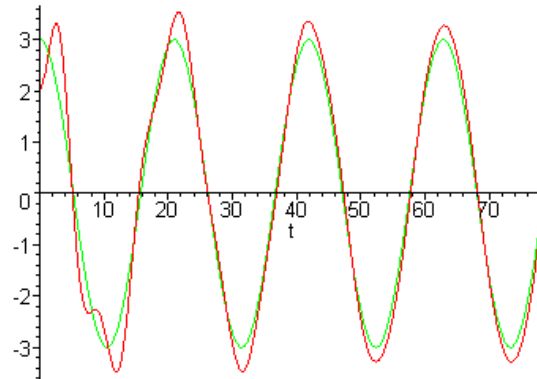

(b).

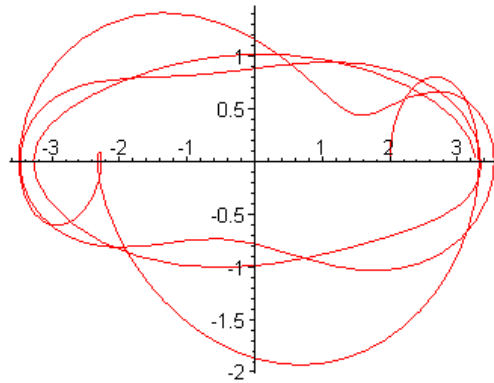

23. The general solution is $u(t) = u_c(t) + U(t)$, in which

$$u_c(t) = e^{-t/16} \left[\frac{9746}{4105} \cos \frac{\sqrt{255}}{16} t + \frac{1258}{821\sqrt{255}} \sin \frac{\sqrt{255}}{16} t \right]$$

and

$$U(t) = \frac{1}{4105} [-1536 \cos(3t) + 72 \sin(3t)].$$

(a).

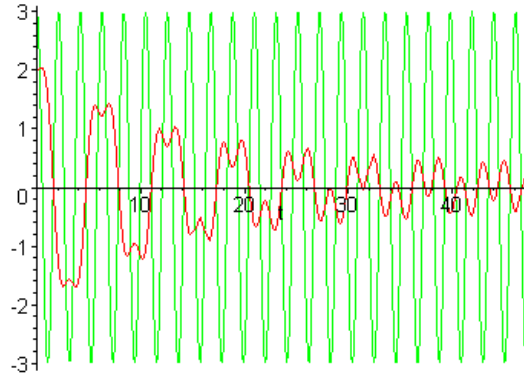

(b).

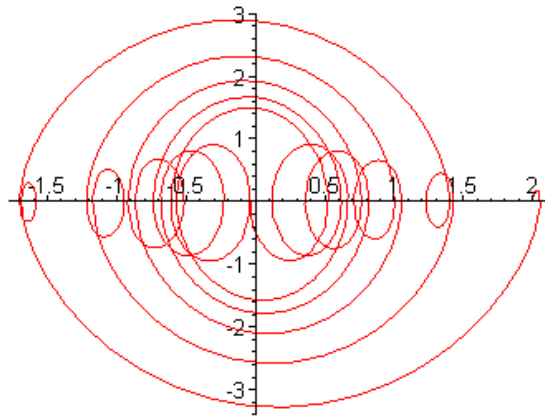

24.

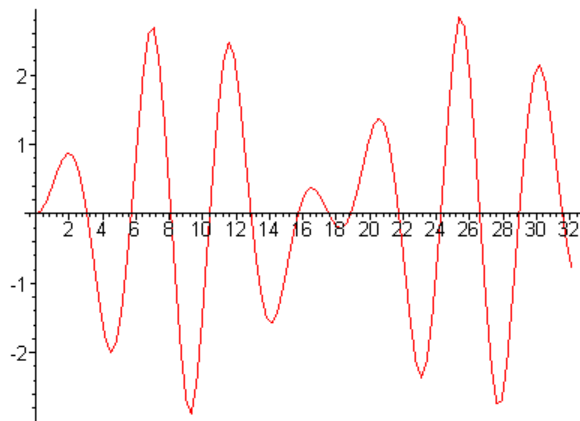

25(a).

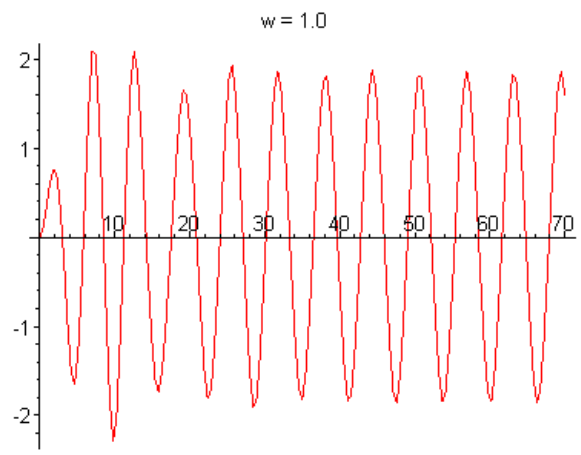
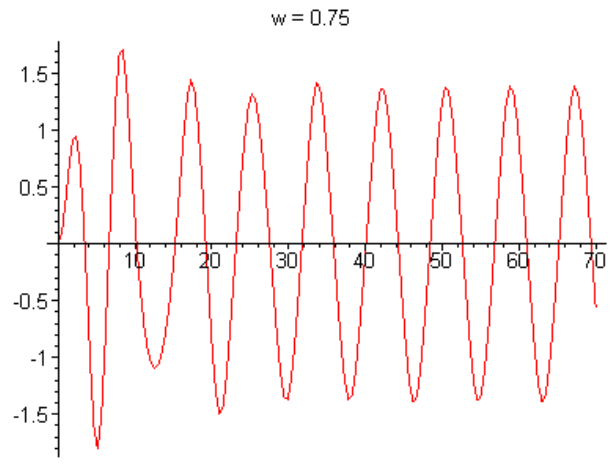
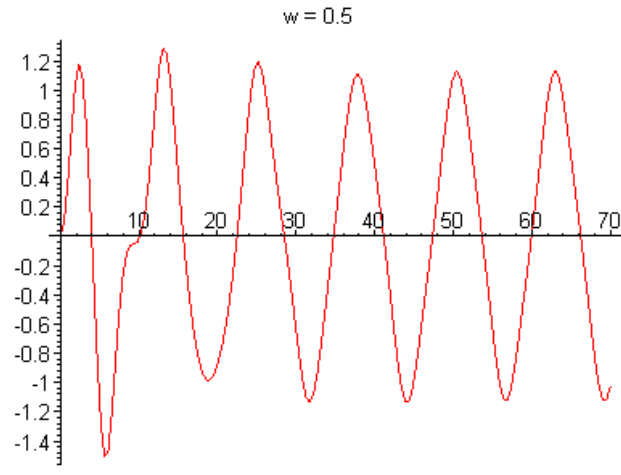

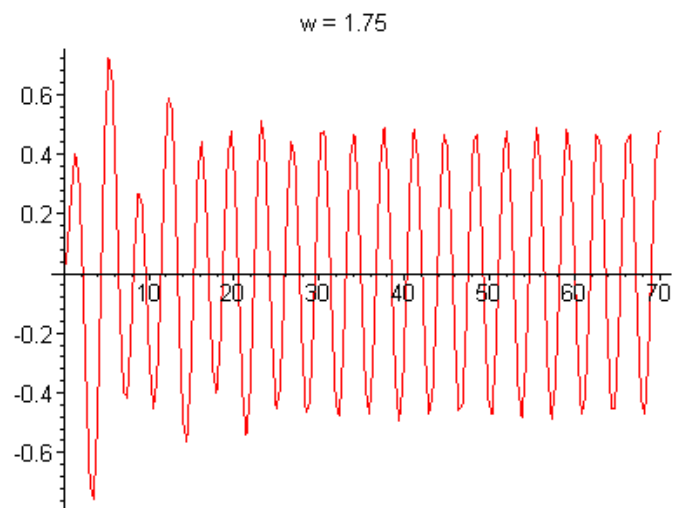
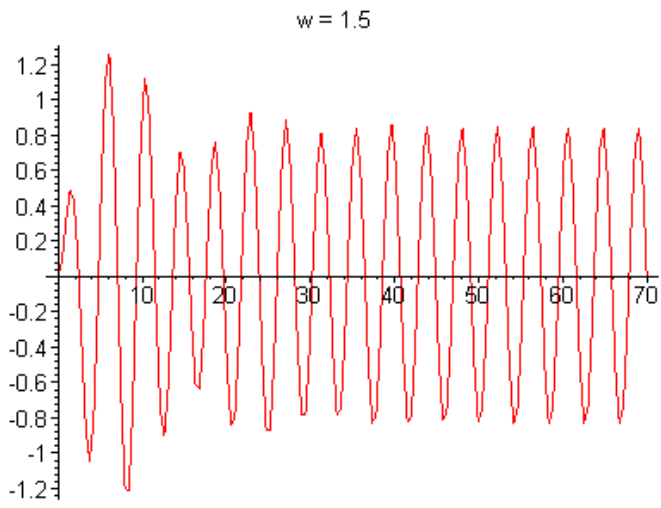
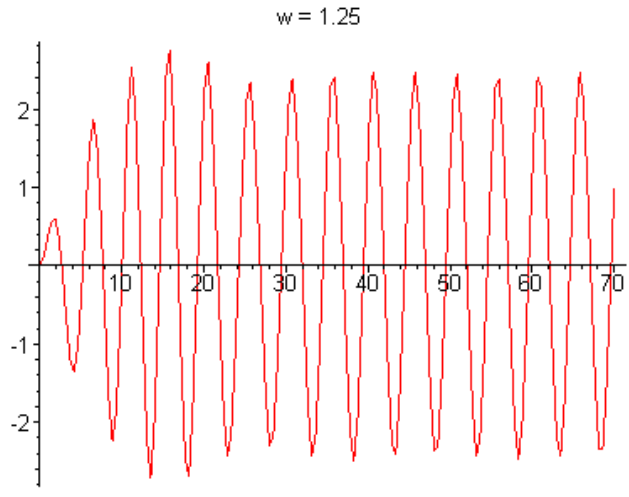

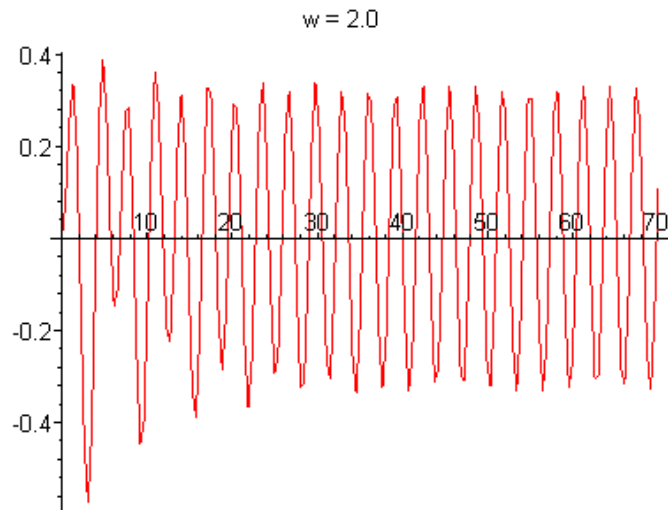

(b).

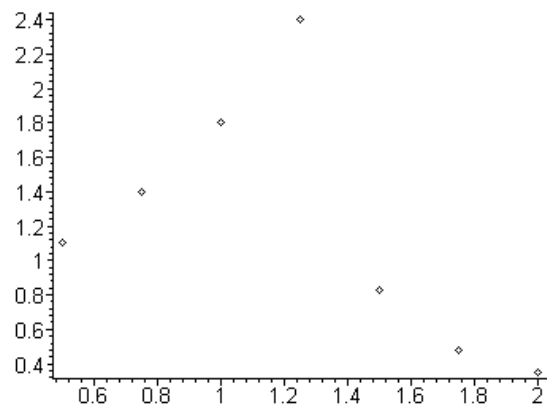

(c). The amplitude for a similar system with a *linear* spring is given by

$$R = \frac{5}{\sqrt{25 - 49\omega^2 + 25\omega^4}}.$$

